

Chains & sprockets	Wear strips	Side guide brackets & accessories	Levelers	Engineering manual
Modular belts & sprockets	Chain & belt return systems	Frame & structure supports	Bearing supports	
Curves & tracks	Side guide solutions	Miscellaneous products	Equipment	

SYSTEM PLAST®

Smart Guide

1 0 1 1 0 a

GENERAL INDEX

www.SystemPlastSmartGuide.com

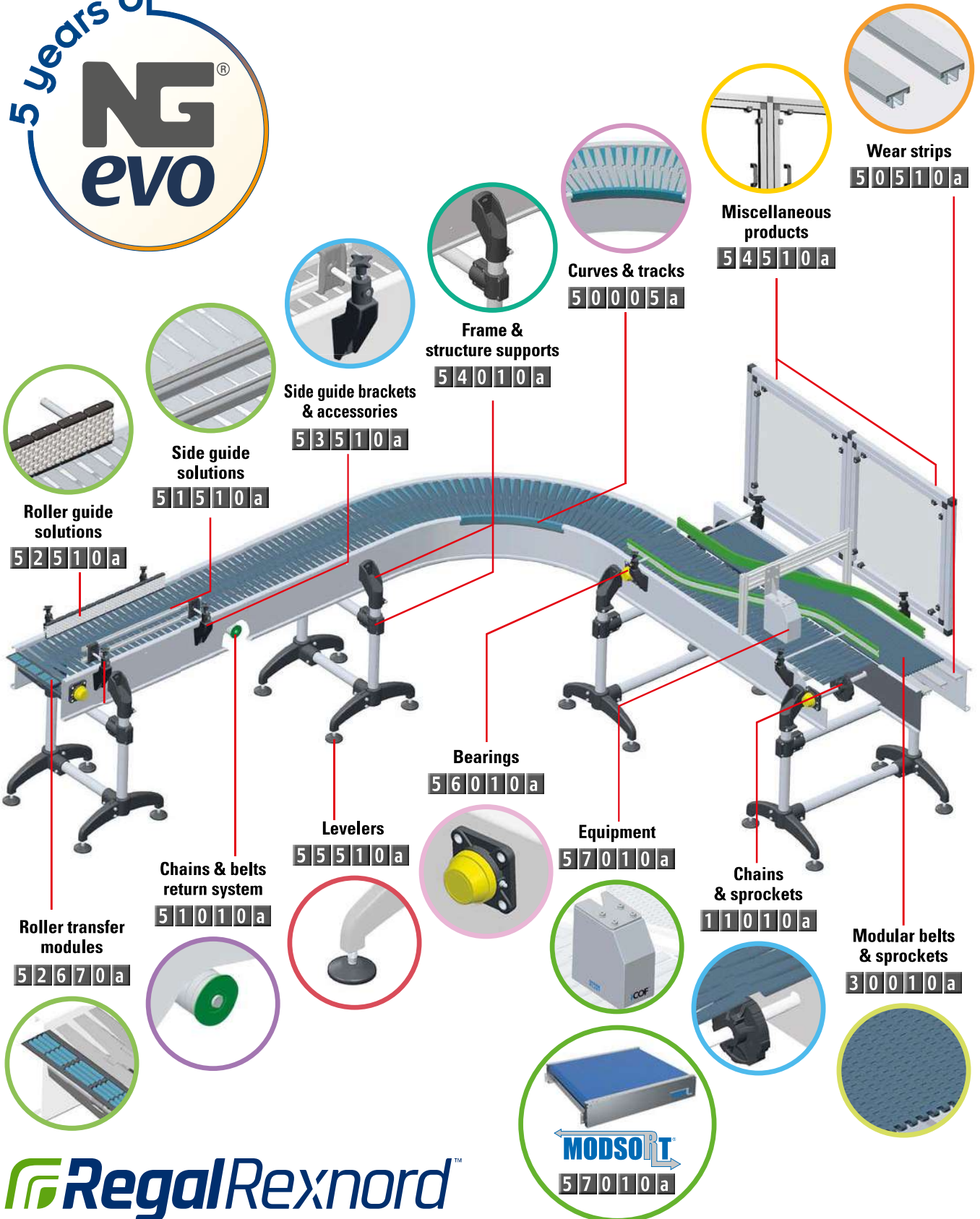











RegalRexnord™















Chains & sprockets	Wear strips	Side guide brackets & accessories	Levelers	Engineering manual
Modular belts & sprockets	Chain & belt return systems	Frame & structure supports	Bearing supports	
Curves & tracks	Side guide solutions	Miscellaneous products	Equipment	

1 0 1 1 0 d

LEGEND ICONS

www.SystemPlastSmartGuide.com

ICON	LEGEND
	Link to open menu for technical information related to the products listed on this page.
1 1 0 1 1 a	Link to find related products.
	Link to find related products. Note: only available on our website www.SystemPlastSmartGuide.com
3 0 7 2 0 a	Codes in orange background are indicators for modular belts in molded to width versions.
	Information only available on our website: www.SystemPlastSmartGuide.com
	Link to other varieties of these chains and/or link to the chains used with the sprockets listed on this page.
	Link to other varieties of these modular belts and/or link to the belts used with the sprockets listed on this page.
	Link to the sprockets used with the chains or belts listed on this page.
MOQ	Minimum order quantity.
	Indicates chains, belts or curves suitable for magnetic curve systems.
	This product includes patented features.
	Link to general information about the products listed on this page.
	This product is not suitable in use with chains with hold-down tabs.

ICON	LEGEND
	Weight in Kg/m
	Length per standard code.
	Length per standard coil.
	Quantity standard packaging.
	Indication for products that contain a dry lubricant.
	Material: stainless steel AISI 430.
	Material: stainless steel AISI 304.
	Material: aluminum, anodized.
	Material: aluminum.
	Material: zinc plated steel.
	Nominal diameter 41mm.
	Product suitable for assembly to a rectangular profile.
	Max load capacity.
	Wrench size.

Chains & sprockets	Wear strips	Side guide brackets & accessories	Levelers	Engineering manual
Modular belts & sprockets	Chain & belt return systems	Frame & structure supports	Bearing supports	
Curves & tracks	Side guide solutions	Miscellaneous products	Equipment	

5 0 0 0 5 a

INTRODUCTION TO CURVES

www.SystemPlastSmartGuide.com

INDEX CURVES GO TO:

5 0 0 1 0 a Index magnetic curves

5 0 0 1 0 b Index curve and straight track for TAB

REGAL OFFERS A COMPLETE RANGE OF CURVES AND STRAIGHT TRACKS, DESIGNED FOR ALL POSSIBLE CONVEYOR APPLICATIONS. BELOW A BRIEF OVERVIEW OF THE VARIOUS CHARACTERISTICS.

BEVEL:

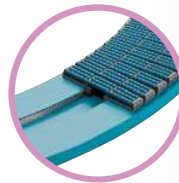
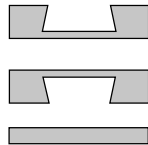
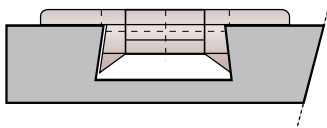

Magnetic system with metal strip: "EXTRA" curves

Regal has developed a magnetic curve retention system for dry-running applications. The system, sets new performance standards in magnet curve technology due to the inclusion of a unique metal strip mounted in the inside bearing face of the top section. This area is constantly under load due to the pressure/speed factor.

Main advantages:

- Extreme dissipation of heat significantly reduces wear.
- Under test conditions, lowest noise decibel levels were recorded.
- "Extra" curves are strongly recommended with plastic chains only!

TAB:

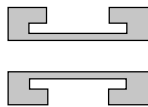
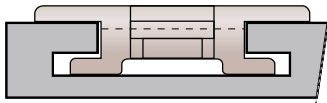

TOPTRAC



TOPTRAC® magnetic curve

System Plast® TopTrac® system is a new concept for magnetic curves, developed by Regal. The Nolu-SR™ interchangeable wear strips allow for higher speeds and loads. New magnet design and material results in a homogenous magnetic field, which improves product stability and productivity. The Nolu-SR wear strips can be quickly replaced, while curve remains fitted in the system.

Go to: **5 0 0 0 6 a**

MAGNETIC:

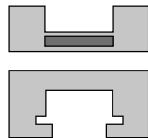
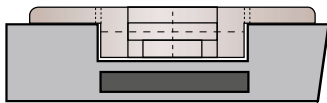

COMPARISON OF CURVE SYSTEMS:

	BEVEL	TAB	MAGNETIC
Secure chain retention:	+	+++	++
Support in return part:	-	++	+
Chain can be lifted for cleaning:	++	-	+++
Jamming due to foreign particles:	+	-	++

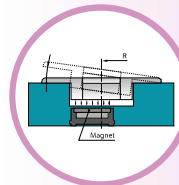

Design and functionality:

Dual Magnetic System curves have the magnets positioned on the outside of the centre line radius of each track which results in a more effective magnetic field through the curve.

SPECIAL CURVES FOR DRY RUNNING APPLICATIONS



Nolu-S™(R) material are a unique compound of UHMWPE and a solid lubricant. They drastically reduce the coefficient of friction, maintaining the characteristics of UHMWPE. Nolu-SR material have a better thermal conductivity compared with UHMWPE.

Benefits and features of Nolu-S(R) material:

- They makes very high speeds possible, especially when running dry.
- They has an extremely low coefficient of friction.
- They reduces noise and squeaking.
- They reduces chain pull.
- They extends the life of the chain.
- They does not damage and scratch the surface of PET.
- They reduces the consumption of energy.
- They is a UHMWPE with a solid lubricant.

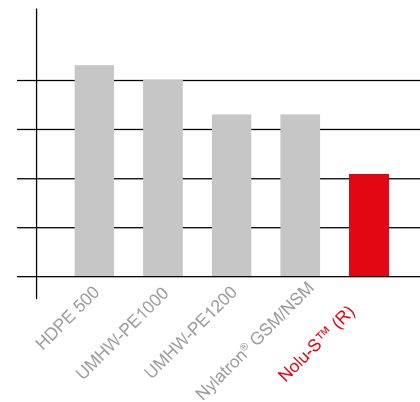
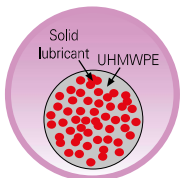

Coefficient of friction comparison of materials

Chains & sprockets	Wear strips	Side guide brackets & accessories	Levelers	Engineering manual
Modular belts & sprockets	Chain & belt return systems	Frame & structure supports	Bearing supports	
Curves & tracks	Side guide solutions	Miscellaneous products	Equipment	

5 0 0 0 6 a

TOPTRAC® CONCEPT / DETAILS

www.SystemPlastSmartGuide.com

i Introduction to curves. Go to: **5 0 0 0 5 a**

New

PATENTED

TOPTRAC®



INDEX CURVES GO TO:
5 0 0 1 0 a Index standard magnetic curves and TOPTRAC®

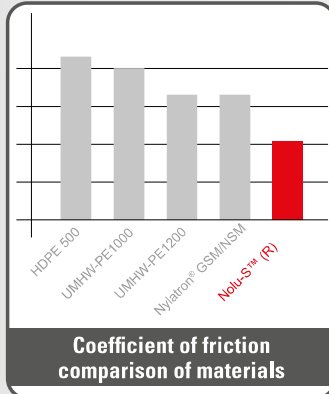
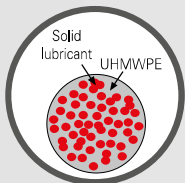

Nolu-S™(R) material are a unique compound of UHMWPE and a solid lubricant. They drastically reduce the coefficient of friction, maintaining the characteristics of UHMWPE. Nolu-SR™ material have a better thermal conductivity compared with UHMWPE.

Benefits and features of Nolu-S(R) material:

- They makes very high speeds possible, especially when running dry.
- They has an extremely low coefficient of friction.
- They reduces noise and squeaking.
- They reduces chain pull.
- They extends the life of the chain.
- They does not damage and scratch the surface of PET.
- They reduces the consumption of energy.
- They is a UHMWPE with a solid lubricant.

NYLATRON is believed to be the trademark and/or trade name of Quadrant EPP USA Inc. and is not owned or controlled by Regal Baloit Corporation.

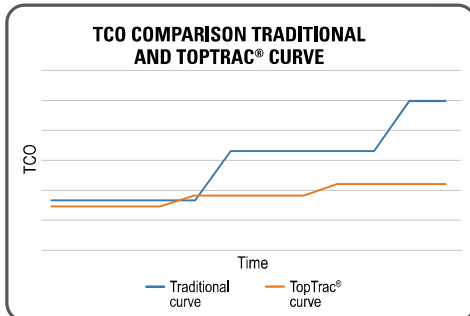

Improves Total Cost of Ownership

- Use high grade material only where required. The base plate is made of basic material. The strips are Nolu-SR.
- When, after some years of use, the curve is due for replacement, only the strips need replacing. Cost of strips is much lower than the cost of an entire curve upperpart.
- Reduces the need of high value spare parts. Just a few strips are enough to be well prepared for maintenance jobs.



Clip-on profiles

- Replaceable Nolu-SR profiles.
- Reduced maintenance and installation time and costs.
- Independent maintenance for each track.
- Replacing the strips can be done with the curve still mounted in the conveyor. This drastically reduces the required time for replacement. Maintenance becomes quicker and easier.

For profiles, go to:

5 0 5 6 5 a

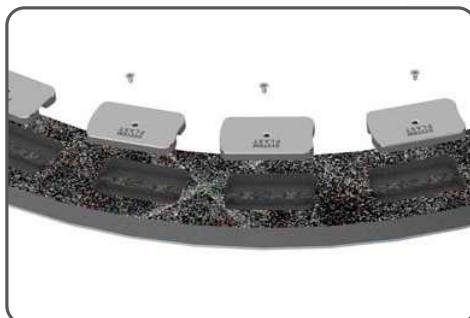

Optimized magnetic field

- Smoother chain operation and reduced risk of stick-slip effect.
- Optimized and homogenous magnetic field with pilot holes similar to standard curve offering for better interchangeability.
- Improved engineered design.
- Better product stability.
- Ferrite Magnets are now screwed into the central rib running across the magnet pocket ensuring positive locking.

Chains & sprockets	Wear strips	Side guide brackets & accessories	Levelers	Engineering manual
Modular belts & sprockets	Chain & belt return systems	Frame & structure supports	Bearing supports	
Curves & tracks	Side guide solutions	Miscellaneous products	Equipment	

5 0 0 1 0 a

INDEX MAGNETIC CURVES

www.SystemPlastSmartGuide.com



Information about this product is only available on our Smart Guide® website.

New TOPTRAC 5 0 0 0 6 a



Introduction to curves. Go to:

5 0 0 0 5 a

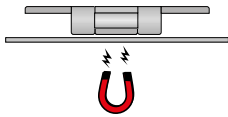

FOR OTHER TYPES OF CURVES AND STRAIGHT TRACKS GO TO:

5 0 0 1 0 b Index curve and straight track for tab

MAGNETIC CURVES CROSS REFERENCE

CHAIN TYPES: 879M-880M-881M / WIDTH: K325-K330	NOMINAL WIDTH mm	PAGE	CURVE TYPE	PAGE	SYSTEM PLAST REFERENCE
	100		K1		TTM01.C/KMD01.C
	111		K2	5 0 0 5 0 a	TTM02.B/KMD02.B
		OTHER VERSIONS:	K3		TTM04.A/KMD04.A
			K4	5 0 0 3 0 a	TTM05.B/KMD05.B
CHAIN TYPES: 880M-881M / WIDTH: K450-K750		PAGE	K5A		TTM07.B/KMD07.B
			K5B		TTM06.B/KMD06.B
CHAIN TYPES: 882M-8857M / WIDTH: K750-K1000-K1200		PAGE	K5C		TTM09.C/KMD09.C
			K5D	5 0 0 2 0 a	TTM10.A/KMD10.A
CHAIN TYPES LBP: 879M-K325 & LBP 882M / WIDTH: K750-K1000-K1200		PAGE	K6		TTM03.B / KMD03.B
			K7		TTM03.A / KMD03.A
CHAINBELT: 2120M / WIDTH: K330		PAGE	K8		TTM08.B/KMD08.B
			K9	5 0 0 5 0 a	TTM62.B/KMD62.B
CHAINBELTS: 2260M / WIDTH: K330		PAGE	K10		TTM61.B/KMD61.B
			K21A		TTM21.C/KMD21.C
CHAINBELTS: 2251M / WIDTH: K330-K450		PAGE	K22A	5 0 0 4 0 a	TTM22.C/KMD22.C
			K27		TTM23.A/KMD23.A
		PAGE	K42	5 0 0 3 0 a	TTM11.B/KMD11.B
		PAGE	K43		TTM12.B/KMD12.B
		PAGE	K61		TTM31.C/KMD31.C
		PAGE	K62	5 0 0 4 0 a	TTM37.A/KMD37.A
		PAGE	K65		TTM33.A/KMD33.A
		PAGE	K66		TTM32.A/KMD32.A
		PAGE	K80		TTM39.B/KMD39.B
		PAGE	K81		TTM40.B/KMD40.B
		PAGE	K85	5 0 0 6 0 a	TTM42.B/KMD42.B
		PAGE	K86		TTM41.A/KMD41.A
		PAGE	K93		TTM48.A/KMD48.A
		PAGE	K97		TTM52.A/KMD52.A
		PAGE	KA4		KMD26
		PAGE	KA6		KMD25
		PAGE	KA7	5 0 0 8 0 a	KMD24
		PAGE	KA8		KMD27
		PAGE	KA42		KMD28
		PAGE	KB4		TTM92.B/KMD92.B
		PAGE	KB5D		TTM96.A/KMD96.A
		PAGE	KB6	5 0 0 9 1 a	TTM91.B/KMD91.B
		PAGE	KB7		TTM90.A/KMD90.A
		PAGE	KB8		TTM93.B/KMD93.B
		PAGE	KC4		TTM86.B/KMD86.B
		PAGE	KC5D		TTM97.A/KMD97.A
		PAGE	KC6		TTM85.B/KMD85.B
		PAGE	KC7	5 0 1 0 1 a	TTM84.A/KMD84.A
		PAGE	KC8		TTM87.B/KMD87.B
		PAGE	KC22		TTM64.B/KMD64.B
		PAGE	KC27		TTM64.B/KMD66.B
		PAGE	LBP68C		TTM68.A/KMD68.A
		PAGE	LBP86C		TTM71.AC/KMD71.AC
		PAGE	LBP93C	5 0 0 7 0 a	TTM78.AC/KMD78.AC
		PAGE	LBP97C		TTM82.AC/KMD82.AC

Chains & sprockets	Wear strips	Side guide brackets & accessories	Levelers	Engineering manual
Modular belts & sprockets	Chain & belt return systems	Frame & structure supports	Bearing supports	
Curves & tracks	Side guide solutions	Miscellaneous products	Equipment	

5 0 0 1 0 b INDEX CURVES AND STRAIGHT TRACKS FOR TAB & BEVEL









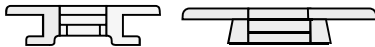



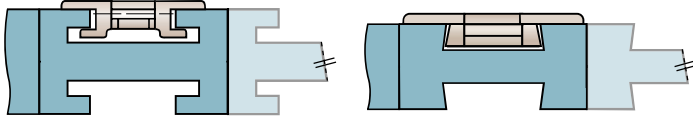



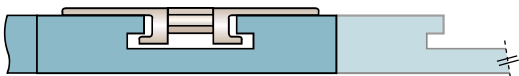

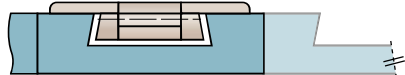
www.SystemPlastSmartGuide.com

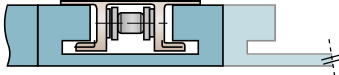
 Information about this product is only available on our Smart Guide® website.

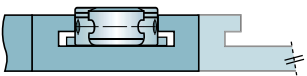
 Introduction to curves. Go to: **5 0 0 0 5 a**

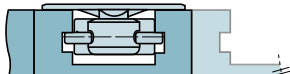
FOR OTHER TYPES OF CURVES GO TO:
5 0 0 1 0 a Index magnetic curves

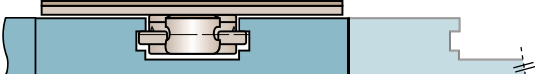

CURVE AND STRAIGHT TRACKS FOR TAB CHAINS CHAIN TYPES: 878-879-880-8810 / WIDTH: TAB K325-330-450-750	PAGE
  1 1 0 7 0 a 1 1 2 3 0 a	5 0 1 1 0 a
COMPACT CURVES AND STRAIGHT TRACKS FOR TAB & BEVEL CHAINS CHAIN TYPES: 878-879-880-8810-2250-2251 / WIDTH: TAB K325-330-450	PAGE
  1 1 0 8 0 a	5 0 1 2 0 a 
CURVES AND STRAIGHT TRACKS FOR BEVEL CHAINS CHAIN TYPES: 879-880-8810 / WIDTH: K325-350-450-750	PAGE
  1 1 2 4 0 a 1 1 0 8 0 a	5 0 1 3 0 a
CURVES AND STRAIGHT TRACKS FOR TAB CHAINS CHAIN TYPES: 882 TAB / WIDTH: K450-750-1000-1200	PAGE
  1 1 2 9 0 a	5 0 1 4 0 a
CURVES AND STRAIGHT TRACKS FOR BEVEL CHAINS CHAIN TYPES: 882 / WIDTH: K450-750-1200	PAGE
  1 1 2 9 0 a	5 0 1 5 0 a 
CURVES AND STRAIGHT TRACKS FOR TAB CHAINS CHAIN TYPES: 1863-1873-1874	PAGE
  1 1 1 4 0 a 1 1 4 7 0 a	5 0 1 6 0 a 
CURVES FOR MULTIFLEX TAB CHAINS	PAGE
  1 1 5 3 0 a	5 0 1 7 0 a 
  1 1 5 4 0 a	5 0 1 7 0 a 
CURVES FOR MULTIFLEX CHAINS WITH TOP PLATES	PAGE
  1 1 5 4 0 a	5 0 1 8 0 a 

Chains & sprockets	Wear strips	Side guide brackets & accessories	Levelers	Engineering manual
Modular belts & sprockets	Chain & belt return systems	Frame & structure supports	Bearing supports	
Curves & tracks	Side guide solutions	Miscellaneous products	Equipment	

50020a

MAGNETIC CURVES FOR CHAINS 879M-880M-881M / K325-K330

www.SystemPlastSmartGuide.com

RADIUS 500-590-680-750-860-1000 / BASIC WIDTH: 100

For general index, go to:

50010a



For stainless steel magnetic chains, type: **881 M - 881 MO**

Go to:

11060a



For plastic magnetic chains, type: **879 M - 880 M**

Go to:

11220a

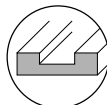

For straight curve go to:

50140a

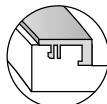

For type curve: **K5B**

New

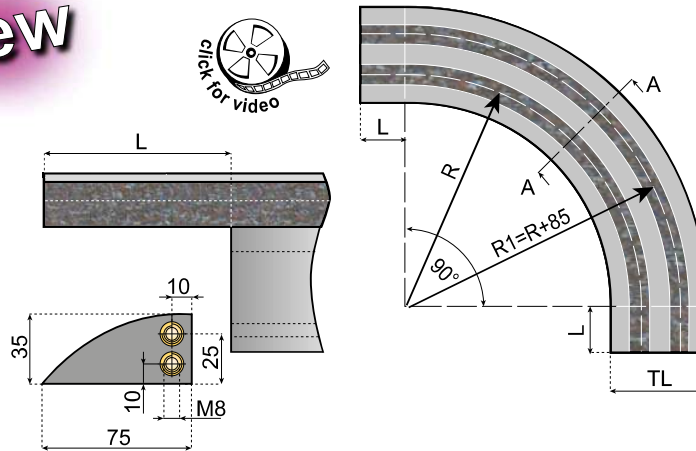

Introduction to curves. Go to: **50005a**

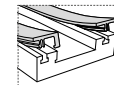

Replacement **50565a**

TOPTRAC

- Replaceable wearstrips
- Lowest coefficient of friction

50006a

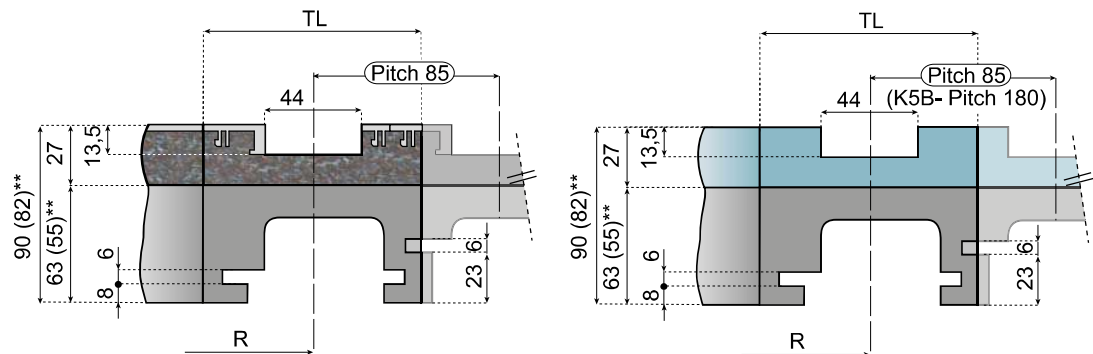

**Dimensions (...) are for 1 - Track version series K5A-K5C-K5D-K7-K8 and 2 Track version K5B.

TRACKS NR.	TL	TYPE CURVE	R	L	TOPTRAC®			STANDARD		
					ITEM DESCRIPTION			ITEM DESCRIPTION		
					30°	45°	90°	30°	45°	90°
					PLATE: K325/K330-WIDTH: 82,5/83,8 mm			PLATE: K325/K330-WIDTH: 82,5/83,8 mm		
1	100	K7	500	0	TTM03-30-01A	TTM03-45-01A	TTM03-90-01A	KMD03-30-01A	KMD03-45-01A	KMD03-90-01A
2	185				TTM03-30-02A	TTM03-45-02A	TTM03-90-02A	KMD03-30-02A	KMD03-45-02A	KMD03-90-02A
3	270				TTM03-30-03A	TTM03-45-03A	TTM03-90-03A	KMD03-30-03A	KMD03-45-03A	KMD03-90-03A
4	355				TTM03-30-04A	TTM03-45-04A	TTM03-90-04A	KMD03-30-04A	KMD03-45-04A	KMD03-90-04A
5	440				TTM03-30-05A	TTM03-45-05A	TTM03-90-05A	KMD03-30-05A	KMD03-45-05A	KMD03-90-05A
6	525				TTM03-30-06A	TTM03-45-06A	TTM03-90-06A	KMD03-30-06A	KMD03-45-06A	KMD03-90-06A
7	610				TTM03-30-07A	TTM03-45-07A	TTM03-90-07A	KMD03-30-07A	KMD03-45-07A	KMD03-90-07A
8	695				TTM03-30-08A	TTM03-45-08A	TTM03-90-08A	KMD03-30-08A	KMD03-45-08A	KMD03-90-08A
1	100	K6	500	100	TTM03-30-01B	TTM03-45-01B	TTM03-90-01B	KMD03-30-01B	KMD03-45-01B	KMD03-90-01B
2	185				TTM03-30-02B	TTM03-45-02B	TTM03-90-02B	KMD03-30-02B	KMD03-45-02B	KMD03-90-02B
3	270				TTM03-30-03B	TTM03-45-03B	TTM03-90-03B	KMD03-30-03B	KMD03-45-03B	KMD03-90-03B
4	355				TTM03-30-04B	TTM03-45-04B	TTM03-90-04B	KMD03-30-04B	KMD03-45-04B	KMD03-90-04B
5	440				TTM03-30-05B	TTM03-45-05B	TTM03-90-05B	KMD03-30-05B	KMD03-45-05B	KMD03-90-05B
6	525				TTM03-30-06B	TTM03-45-06B	TTM03-90-06B	KMD03-30-06B	KMD03-45-06B	KMD03-90-06B
7	610				TTM03-30-07B	TTM03-45-07B	TTM03-90-07B	KMD03-30-07B	KMD03-45-07B	KMD03-90-07B
8	695				TTM03-30-08B	TTM03-45-08B	TTM03-90-08B	KMD03-30-08B	KMD03-45-08B	KMD03-90-08B
2	280	K5B	590	100	TTM06-30-02B	TTM06-45-02B	TTM06-90-02B	KMD06-30-02B	KMD06-45-02B	KMD06-90-02B
1	100	K5A	680	100	TTM07-30-01B	TTM07-45-01B	TTM07-90-01B	KMD07-30-01B	KMD07-45-01B	KMD07-90-01B
1	100	K8	750	100	TTM08-30-01B	TTM08-45-01B	TTM08-90-01B	KMD08-30-01B	KMD08-45-01B	KMD08-90-01B
1	100	K5C	860	125	TTM09-30-01C	TTM09-45-01C	TTM09-90-01C	KMD09-30-01C	KMD09-45-01C	KMD09-90-01C
1	100	K5D	1000	0	TTM10-30-01A	TTM10-45-01A	TTM10-90-01A	KMD10-30-01A	KMD10-45-01A	KMD10-90-01A

• More tracks and different angles available on request.

Chains & sprockets	Wear strips	Side guide brackets & accessories	Levelers	Engineering manual
Modular belts & sprockets	Chain & belt return systems	Frame & structure supports	Bearing supports	
Curves & tracks	Side guide solutions	Miscellaneous products	Equipment	

50030a

MAGNETIC CURVES FOR CHAINS 879M-880M-881M / K325-K330

www.SystemPlastSmartGuide.com

RADIUS 500-750-1000 / BASIC WIDTH: 111

For general index, go to:

50010a

New



For stainless steel magnetic chains, type: **881 M - 881 MO**

Go to:

11060a



For plastic magnetic chains, type: **879 M - 880 M**

Go to:

11220a

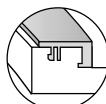

For type curve: **K4 - K42 - K43**

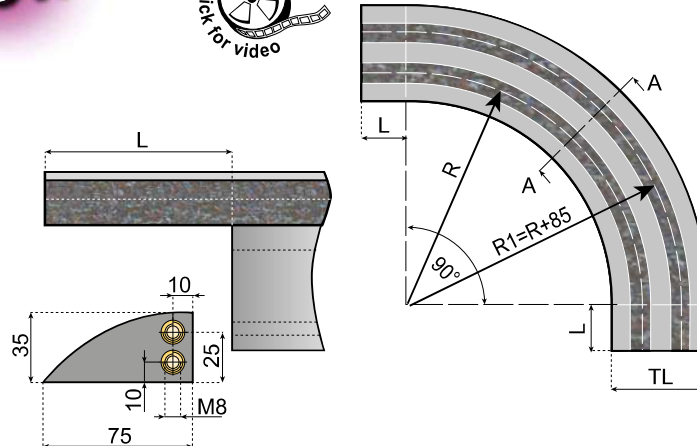

i Introduction to curves. Go to: **50005a**

Replacement **50565a**

TOPTRAC
- Replaceable wearstrips
- Lowest coefficient of friction
50006a

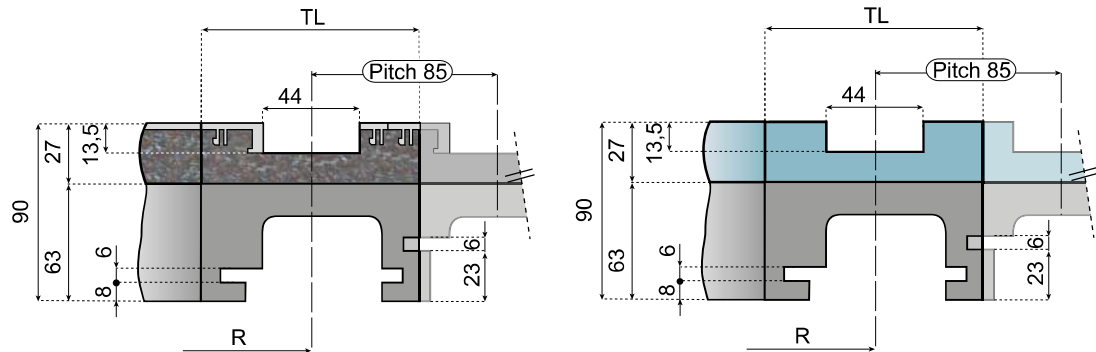

TRACKS NR.	TL	TYPE CURVE	R	L	TOPTRAC®			STANDARD		
					ITEM DESCRIPTION			ITEM DESCRIPTION		
					30°	45°	90°	30°	45°	90°
					PLATE: K325/K330-WIDTH: 82,5/83,8 mm			PLATE: K325/K330-WIDTH: 82,5/83,8 mm		
1	111	K4	500	100	TTM05-30-01B	TTM05-45-01B	TTM05-90-01B	KMD05-30-01B	KMD05-45-01B	KMD05-90-01B
2	196				TTM05-30-02B	TTM05-45-02B	TTM05-90-02B	KMD05-30-02B	KMD05-45-02B	KMD05-90-02B
3	281				TTM05-30-03B	TTM05-45-03B	TTM05-90-03B	KMD05-30-03B	KMD05-45-03B	KMD05-90-03B
4	366				TTM05-30-04B	TTM05-45-04B	TTM05-90-04B	KMD05-30-04B	KMD05-45-04B	KMD05-90-04B
5	451				TTM05-30-05B	TTM05-45-05B	TTM05-90-05B	KMD05-30-05B	KMD05-45-05B	KMD05-90-05B
6	536				TTM05-30-06B	TTM05-45-06B	TTM05-90-06B	KMD05-30-06B	KMD05-45-06B	KMD05-90-06B
7	621				TTM05-30-07B	TTM05-45-07B	TTM05-90-07B	KMD05-30-07B	KMD05-45-07B	KMD05-90-07B
8	706				TTM05-30-08B	TTM05-45-08B	TTM05-90-08B	KMD05-30-08B	KMD05-45-08B	KMD05-90-08B
1	111	K42	750	100	TTM11-30-01B	TTM11-45-01B	TTM11-90-01B	KMD11-30-01B	KMD11-45-01B	KMD11-90-01B
2	196				TTM11-30-02B	TTM11-45-02B	TTM11-90-02B	KMD11-30-02B	KMD11-45-02B	KMD11-90-02B
3	281				TTM11-30-03B	TTM11-45-03B	TTM11-90-03B	KMD11-30-03B	KMD11-45-03B	KMD11-90-03B
1	111	K43	1000	100	TTM12-30-01B	TTM12-45-01B	TTM12-90-01B	KMD12-30-01B	KMD12-45-01B	KMD12-90-01B

• More tracks and different angles available on request.

Chains & sprockets	Wear strips	Side guide brackets & accessories	Levelers	Engineering manual
Modular belts & sprockets	Chain & belt return systems	Frame & structure supports	Bearing supports	
Curves & tracks	Side guide solutions	Miscellaneous products	Equipment	

50040a

MAGNETIC CURVES FOR CHAINS 879M-880M-881M/K450

www.SystemPlastSmartGuide.com

RADIUS 500-610

For general index, go to:

50010a



For stainless steel magnetic chains, type: **881 M - 881 MO** K450
Go to:

11060a



For plastic magnetic chains, type: **879 M - 880 M** K450
Go to:

11220a

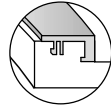

For type curve: **K27-K21A-K22A**

New



Introduction to curves. Go to:

50005a

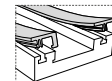

Replacement

50565a

TOPTRAC®

- Replaceable wearstrips
- Lowest coefficient of friction

50006a

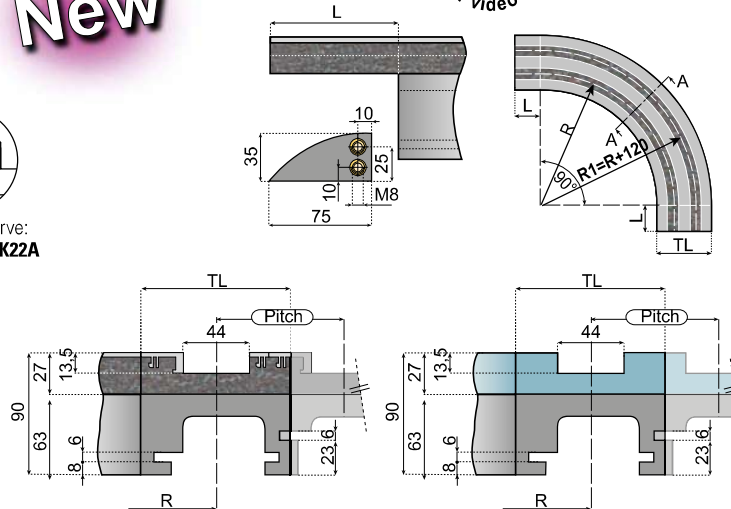

TRACKS NR.	TL	TYPE CURVE	R	L	PITCH	TOPTRAC®			STANDARD		
						ITEM DESCRIPTION			ITEM DESCRIPTION		
						30°	45°	90°	30°	45°	90°
						PLATE: K450-WIDTH: 114,3 mm					
1	129	K27	610	0	117	TTM23-30-01A	TTM23-45-01A	TTM23-90-01A	KMD23-30-01A	KMD23-45-01A	KMD23-90-01A
2	246			0		-	-	-	KMD23-30-02A	KMD23-45-02A	KMD23-90-02A
1	129	K21A	500	125	120	TTM21-30-01C	TTM21-45-01C	TTM21-90-01C	KMD21-30-01C	KMD21-45-01C	KMD21-90-01C
1	129	K22A	610	125	120	TTM22-30-01C	TTM22-45-01C	TTM22-90-01C	KMD22-30-01C	KMD22-45-01C	KMD22-90-01C

• More tracks and different angles available on request.

MAGNETIC CURVES FOR CHAINS 879M-880M-881M/K750

RADIUS 610-750-860-1000

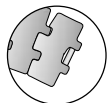

For stainless steel magnetic chains, type: **881 M - 881 MO** K750
Go to:

11060a



For plastic magnetic chains, type: **879 M - 880 M** K750
Go to:

11220a

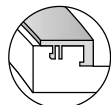

For type curve: **K61-K62-K66-K65**

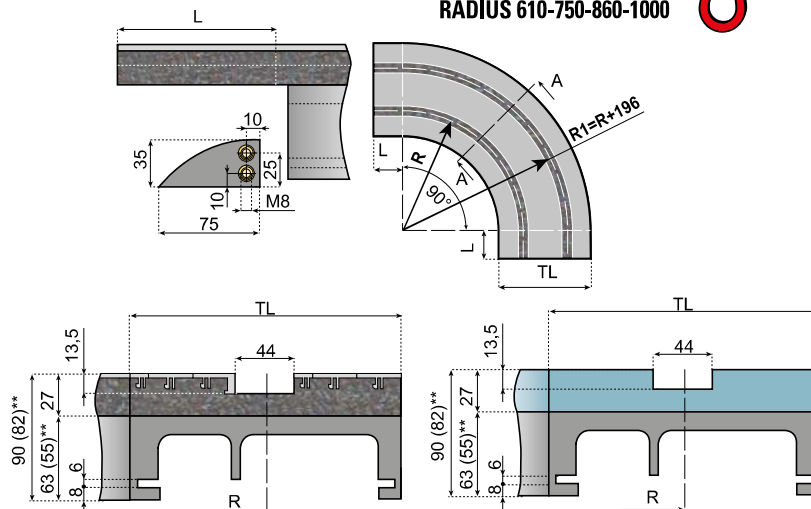

**Dimensions (...) are for 1 - Track version series K62-K65-K66.

TRACKS NR.	TL	TYPE CURVE	R	L	TOPTRAC®			STANDARD			
					ITEM DESCRIPTION			ITEM DESCRIPTION			
					30°	45°	90°	30°	45°	90°	
						PLATE: K750-WIDTH: 190,5 mm					
1	214	K61	610	125	TTM31-30-01C	TTM31-45-01C	TTM31-90-01C	KMD31-30-01C	KMD31-45-01C	KMD31-90-01C	
1	214	K62**	750	0	TTM37-30-01A	TTM37-45-01A	TTM37-90-01A	KMD37-30-01A	KMD37-45-01A	KMD37-90-01A	
1	214	K66**	860	0	TTM32-30-01A	TTM32-45-01A	TTM32-90-01A	KMD32-30-01A	KMD32-45-01A	KMD32-90-01A	
1	214	K65**	1000	0	TTM33-30-01A	TTM33-45-01A	TTM33-90-01A	KMD33-30-01A	KMD33-45-01A	KMD33-90-01A	

• More tracks and different angles available on request.

Chains & sprockets	Wear strips	Side guide brackets & accessories	Levelers	Engineering manual
Modular belts & sprockets	Chain & belt return systems	Frame & structure supports	Bearing supports	
Curves & tracks	Side guide solutions	Miscellaneous products	Equipment	

50050a

MAGNETIC CURVES FOR CHAINS 879M/880M/881M-K325-330

www.SystemPlastSmartGuide.com

RADIUS 500-750 / OTHER VERSIONS

For general index, go to:

50010a



For stainless steel magnetic chains, type: **881 M - 881 MO**, go to:

11060a



For plastic magnetic chains, type: **879 M - 880 M**, go to:

11220a

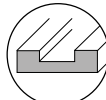

For straight curve go to:

50140a

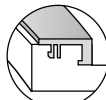

For type curve: **K3 - K9 - K10**

New

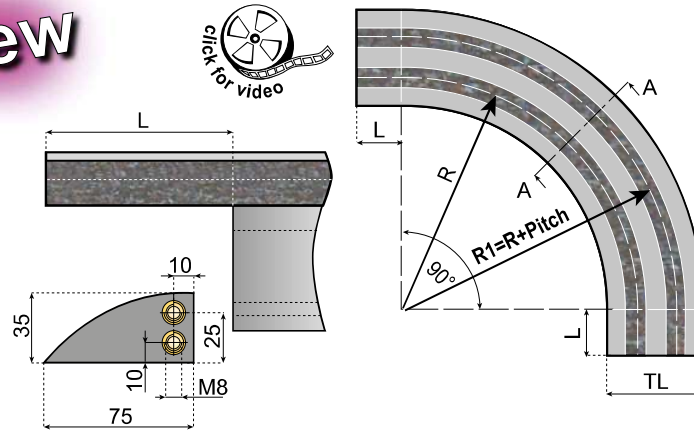

Introduction to curves. Go to:

50005a

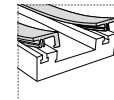

Replacement

50565a

TOPTRAC

- Replaceable wearstrips
- Lowest coefficient of friction

50006a

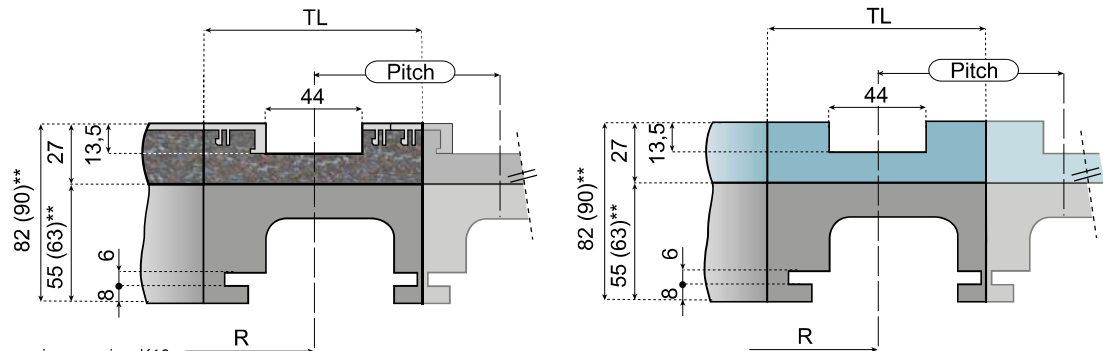

**Dimensions (...) are for all versions series K10.

TRACKS NR.	TL	TYPE CURVE	R	L	PITCH	TOPTRAC®			STANDARD		
						ITEM DESCRIPTION			ITEM DESCRIPTION		
						30°	45°	90°	30°	45°	90°
						PLATE: K325/K330-WIDTH: 82,5/83,8 mm					
1	100	K1	500	125	89	TTM01-30-01C	TTM01-45-01C	TTM01-90-01C	KMD01-30-01C	KMD01-45-01C	KMD01-90-01C
2	189					-	-	-	KMD01-30-02C	KMD01-45-02C	KMD01-90-02C
3	278					-	-	-	KMD01-30-03C	KMD01-45-03C	KMD01-90-03C
4	367					-	-	-	KMD01-30-04C	KMD01-45-04C	KMD01-90-04C
5	456					-	-	-	KMD01-30-05C	KMD01-45-05C	KMD01-90-05C
6	545					-	-	-	KMD01-30-06C	KMD01-45-06C	KMD01-90-06C
1	100	K2	500	100	90	TTM02-30-01B	TTM02-45-01B	TTM02-90-01B	KMD02-30-01B	KMD02-45-01B	KMD02-90-01B
2	190					-	-	-	KMD02-30-02B	KMD02-45-02B	KMD02-90-02B
3	280					-	-	-	KMD02-30-03B	KMD02-45-03B	KMD02-90-03B
4	370					-	-	-	KMD02-30-04B	KMD02-45-04B	KMD02-90-04B
5	460					-	-	-	KMD02-30-05B	KMD02-45-05B	KMD02-90-05B
6	550					-	-	-	KMD02-30-06B	KMD02-45-06B	KMD02-90-06B
1	110	K10**	500	100	85	TTM61-30-01B	TTM61-45-01B	TTM61-90-01B	KMD61-30-01B	KMD61-45-01B	KMD61-90-01B
2	195					TTM61-30-02B	TTM61-45-02B	TTM61-90-02B	KMD61-30-02B	KMD61-45-02B	KMD61-90-02B
3	280					TTM61-30-03B	TTM61-45-03B	TTM61-90-03B	KMD61-30-03B	KMD61-45-03B	KMD61-90-03B
4	365					TTM61-30-04B	TTM61-45-04B	TTM61-90-04B	KMD61-30-04B	KMD61-45-04B	KMD61-90-04B
5	450					TTM61-30-05B	TTM61-45-05B	TTM61-90-05B	KMD61-30-05B	KMD61-45-05B	KMD61-90-05B
6	535					TTM61-30-06B	TTM61-45-06B	TTM61-90-06B	KMD61-30-06B	KMD61-45-06B	KMD61-90-06B
7	620					TTM61-30-07B	TTM61-45-07B	TTM61-90-07B	KMD61-30-07B	KMD61-45-07B	KMD61-90-07B
8	705					TTM61-30-08B	TTM61-45-08B	TTM61-90-08B	KMD61-30-08B	KMD61-45-08B	KMD61-90-08B
1	110	K3	500	0	90	TTM04-30-01A	TTM04-45-01A	TTM04-90-01A	KMD04-30-01A	KMD04-45-01A	KMD04-90-01A
2	200					-	-	-	KMD04-30-02A	KMD04-45-02A	KMD04-90-02A
1	110	K9	750	100	90	TTM62-30-01B	TTM62-45-01B	TTM62-90-01B	KMD62-30-01B	KMD62-45-01B	KMD62-90-01B

• More tracks and different angles available on request.

Chains & sprockets	Wear strips	Side guide brackets & accessories	Levelers	Engineering manual
Modular belts & sprockets	Chain & belt return systems	Frame & structure supports	Bearing supports	
Curves & tracks	Side guide solutions	Miscellaneous products	Equipment	

50060a

MAGNETIC CURVES FOR CHAINS 882M-8857M/K750-K1000-K1200

www.SystemPlastSmartGuide.com

RADIUS 500-750-1000 / OTHER VERSIONS

For general index, go to:

50010a

New



For stainless steel magnetic chains, type: **8857M**

Go to:

11110a

8857M VG

Go to:

11160a

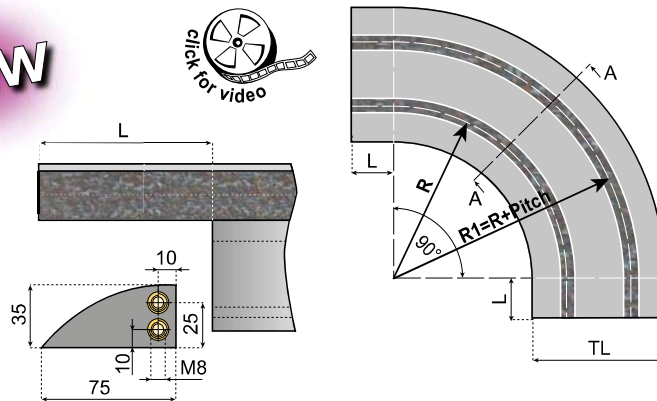

Introduction to curves. Go to:

50005a

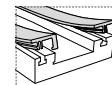

Replacement

50565a

TOPTRAC

- Replaceable wearstrips
- Lowest coefficient of friction

50006a



For plastic magnetic chains, type: **882M**

Go to:

11280a

882 M VG

Go to:

11400a

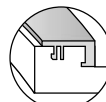
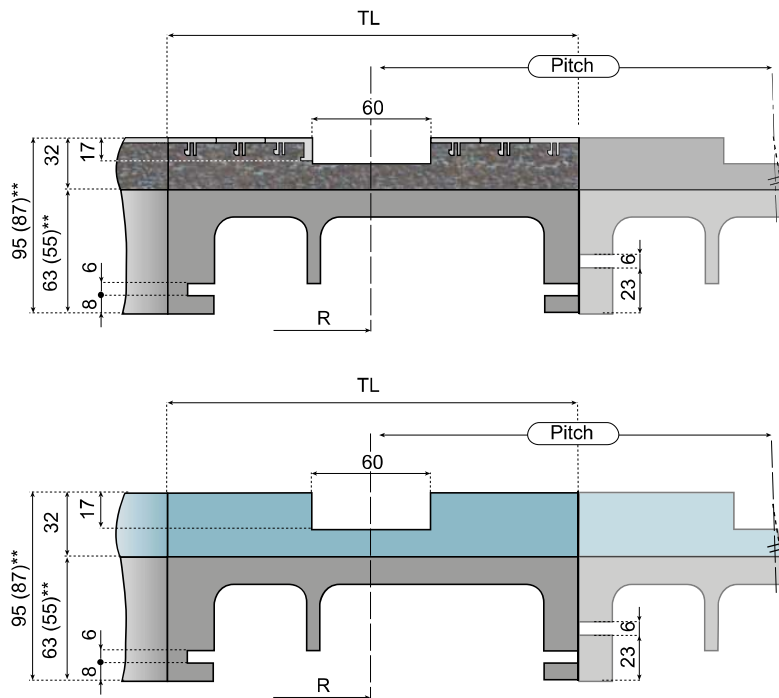

For type curve: **K86-K93-K97**

* K81-only suitable for thermoplastic chains.

** Dimensions (...) are for 1-Track version series K80-K85-K86.

TRACKS NR.	TL	TYPE CURVE	R	L	PITCH	TOPTRAC®			STANDARD		
						ITEM DESCRIPTION			ITEM DESCRIPTION		
						30°	45°	90°	30°	45°	90°
						PLATE: K750-WIDTH: 190,5 mm			PLATE: K750-WIDTH: 190,5 mm		
1	200	K81*	610	100	195	TTM40-30-01B	TTM40-45-01B	TTM40-90-01B	KMD40-30-01B	KMD40-45-01B	KMD40-90-01B
2	395					-	-	-	KMD40-30-02B	KMD40-45-02B	KMD40-90-02B
						PLATE: K750-WIDTH: 190,5 mm			PLATE: K750-WIDTH: 190,5 mm		
1	200	K85**	750	100	195	TTM42-30-01B	TTM42-45-01B	TTM42-90-01B	KMD42-30-01B	KMD42-45-01B	KMD42-90-01B
2	395					-	-	-	KMD42-30-02B	KMD42-45-02B	KMD42-90-02B
						PLATE: K750-WIDTH: 190,5 mm			PLATE: K750-WIDTH: 190,5 mm		
1	214	K86**	860	0	200	TTM41-30-01A	TTM41-45-01A	TTM41-90-01A	KMD41-30-01A	KMD41-45-01A	KMD41-90-01A
2	414					-	-	-	KMD41-30-02A	KMD41-45-02A	KMD41-90-02A
						PLATE: K750-WIDTH: 190,5 mm			PLATE: K750-WIDTH: 190,5 mm		
1	200	K80**	1000	100	195	TTM39-30-01B	TTM39-45-01B	TTM39-90-01B	KMD39-30-01B	KMD39-45-01B	KMD39-90-01B
						PLATE: K1000-WIDTH: 254 mm			PLATE: K1000-WIDTH: 254 mm		
1	270	K93	860	0	-	TTM48-30-01A	TTM48-45-01A	TTM48-90-01A	KMD48-30-01A	KMD48-45-01A	KMD48-90-01A
						PLATE: K1200-WIDTH: 304,8 mm			PLATE: K1200-WIDTH: 304,8 mm		
1	320	K97	860	0	-	TTM52-30-01A	TTM52-45-01A	TTM52-90-01A	KMD52-30-01A	KMD52-45-01A	KMD52-90-01A

• More tracks and different angles available on request.

Chains & sprockets	Wear strips	Side guide brackets & accessories	Levelers	Engineering manual
Modular belts & sprockets	Chain & belt return systems	Frame & structure supports	Bearing supports	
Curves & tracks	Side guide solutions	Miscellaneous products	Equipment	

50070a

MAGNETIC CURVES FOR CHAINS LBP 879M / K325

RADIUS 500 / OTHER VERSIONS

For general index, go to:

50010a

New

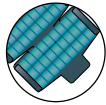

For plastic magnetic chains, type: **LBP 879 M**

Go to:

11350a

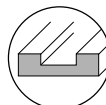

For straight curve go to:

50140a

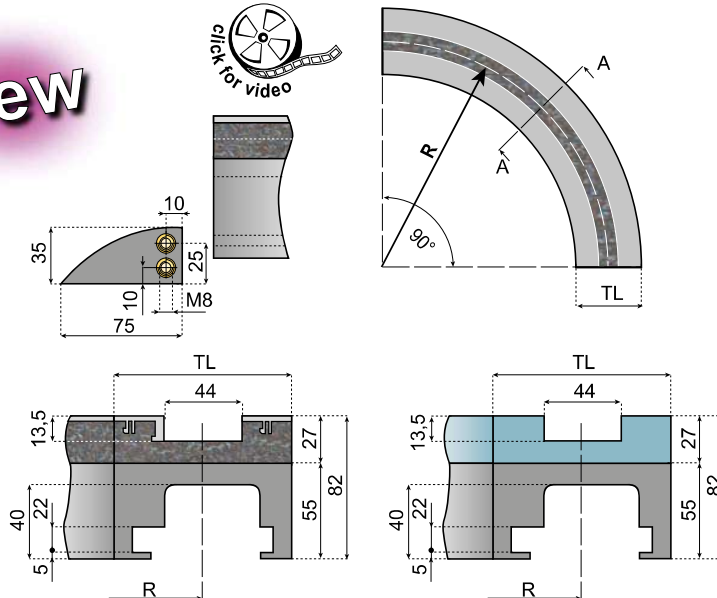

i Introduction to curves. Go to: **50005a**

Replacement **50565a**

TOPTRAC®
- Replaceable wearstrips
- Lowest coefficient of friction
50006a

TRACKS NR.	TL	TYPE CURVE	R	TOPTRAC®			STANDARD		
				ITEM DESCRIPTION			ITEM DESCRIPTION		
				30°	45°	90°	30°	45°	90°
				PLATE: K325/K330-WIDTH: 82,5/83,8 mm			PLATE: K325/K330-WIDTH: 82,5/83,8 mm		
1	100	LBP68C	500	TTM68-30-01A	TTM68-45-01A	TTM68-90-01A	KMD68-30-01A	KMD68-45-01A	KMD68-90-01A

MAGNETIC CURVES FOR CHAIN LBP 882M / K750-1000-1200

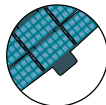

For plastic magnetic chains, type: **882M**

Go to:

11360a

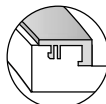

For type curve: **LBP86C-LBP93C LBP97C**

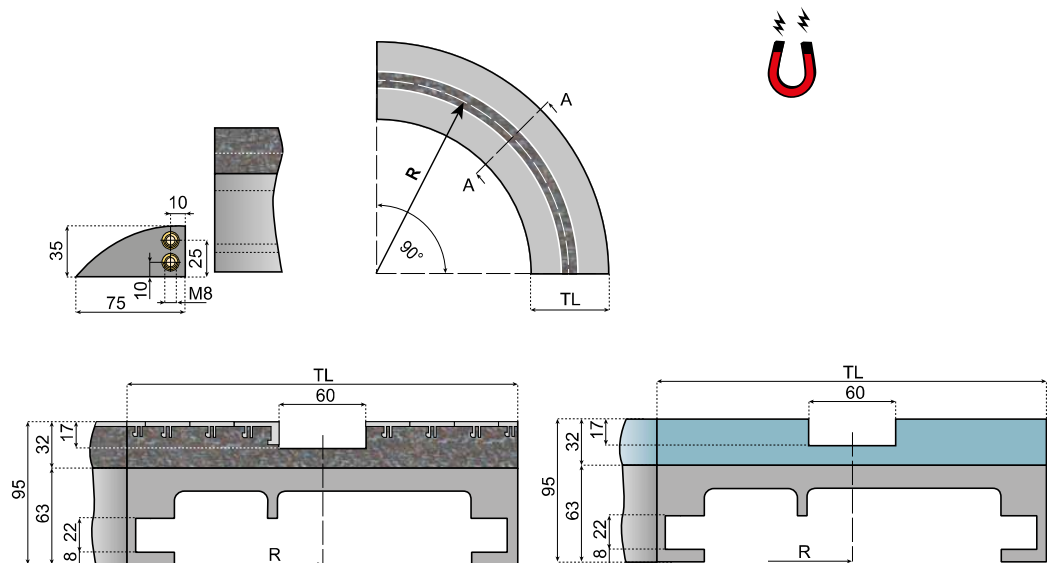

TRACKS NR.	TL	TYPE CURVE	R	TOPTRAC®			STANDARD		
				ITEM DESCRIPTION			ITEM DESCRIPTION		
				30°	45°	90°	30°	45°	90°
				PLATE: K750-WIDTH: 190,5 mm			PLATE: K750-WIDTH: 190,5 mm		
1	214	LBP86C	860	TTM71-30-01AC	TTM71-45-01AC	TTM71-90-01AC	KMD71-30-01AC	KMD71-45-01AC	KMD71-90-01AC
				PLATE: K1000-WIDTH: 254 mm			PLATE: K1000-WIDTH: 254 mm		
1	270	LBP93C	860	TTM78-30-01AC	TTM78-45-01AC	TTM78-90-01AC	KMD78-30-01AC	KMD78-45-01AC	KMD78-90-01AC
				PLATE: K1200-WIDTH: 304,8 mm			PLATE: K1200-WIDTH: 304,8 mm		
1	320	LBP97C	860	TTM82-30-01AC	TTM82-45-01AC	TTM82-90-01AC	KMD82-30-01AC	KMD82-45-01AC	KMD82-90-01AC

• More tracks and different angles available on request.

Chains & sprockets	Wear strips	Side guide brackets & accessories	Levelers	Engineering manual
Modular belts & sprockets	Chain & belt return systems	Frame & structure supports	Bearing supports	
Curves & tracks	Side guide solutions	Miscellaneous products	Equipment	

5 0 0 8 0 a

MAGNETIC CURVES FOR CHAINBELT SERIES 2120M / K330

www.SystemPlastSmartGuide.com

RADIUS 500-750-1000 / BASIC WIDTHS: 100 AND 111

For general index, go to:

5 0 0 1 0 a

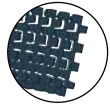

For sideflexing belts, type: 2120 M

Go to:

3 0 7 2 0 a

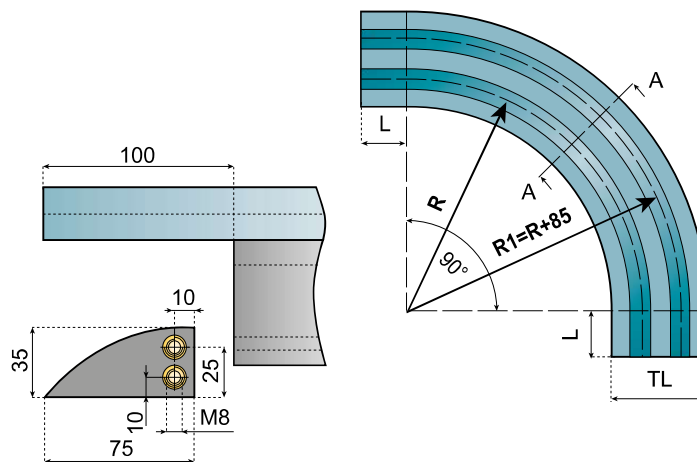

Introduction to curves. Go to:

5 0 0 0 5 a

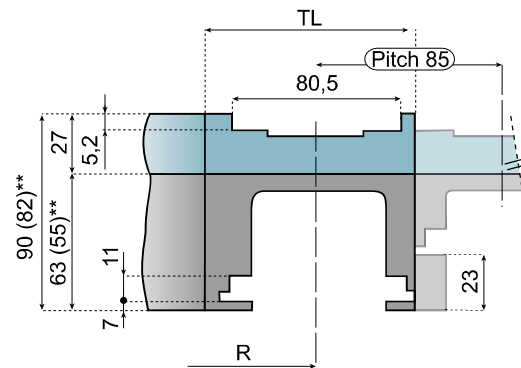

**Dimensions (...) are valid for the 1 Track version of curve type KA7.

TRACKS NR.	TL	TYPE CURVE	R	L	30° ITEM DESCRIPTION	45° ITEM DESCRIPTION	90° ITEM DESCRIPTION
PLATE: K325/K330-WIDTH: 82,5/83,8 mm							
1	100	KA7**	500	0	KMD24-30-01A	KMD24-45-01A	KMD24-90-01A
2	185				KMD24-30-02A	KMD24-45-02A	KMD24-90-02A
3	270				KMD24-30-03A	KMD24-45-03A	KMD24-90-03A
4	355				KMD24-30-04A	KMD24-45-04A	KMD24-90-04A
1	100	KA6	500	100	KMD25-30-01B	KMD25-45-01B	KMD25-90-01B
2	185				KMD25-30-02B	KMD25-45-02B	KMD25-90-02B
3	270				KMD25-30-03B	KMD25-45-03B	KMD25-90-03B
4	355				KMD25-30-04B	KMD25-45-04B	KMD25-90-04B
5	440				KMD25-30-05B	KMD25-45-05B	KMD25-90-05B
6	525				KMD25-30-06B	KMD25-45-06B	KMD25-90-06B
1	100	KA8	750	100	KMD27-30-01B	KMD27-45-01B	KMD27-90-01B
2	185				KMD27-30-02B	KMD27-45-02B	KMD27-90-02B
1	111	KA4	500	100	KMD26-30-01B	KMD26-45-01B	KMD26-90-01B
2	196				KMD26-30-02B	KMD26-45-02B	KMD26-90-02B
1	111	KA42	750	100	KMD28-30-01B	KMD28-45-01B	KMD28-90-01B

• More tracks and different angles available on request.

Chains & sprockets	Wear strips	Side guide brackets & accessories	Levelers	Engineering manual
Modular belts & sprockets	Chain & belt return systems	Frame & structure supports	Bearing supports	
Curves & tracks	Side guide solutions	Miscellaneous products	Equipment	

50091a

MAGNETIC CURVES CHAINBELT 2260M / K330

www.SystemPlastSmartGuide.com

RADIUS 500-750-1000

For general index, go to:

50010a

New



For sideflexing chainbelts, type: **2260M**

Go to:

30700a

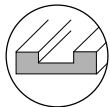

For straight curve go to:

50140a

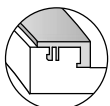

For type curve: **KB4**

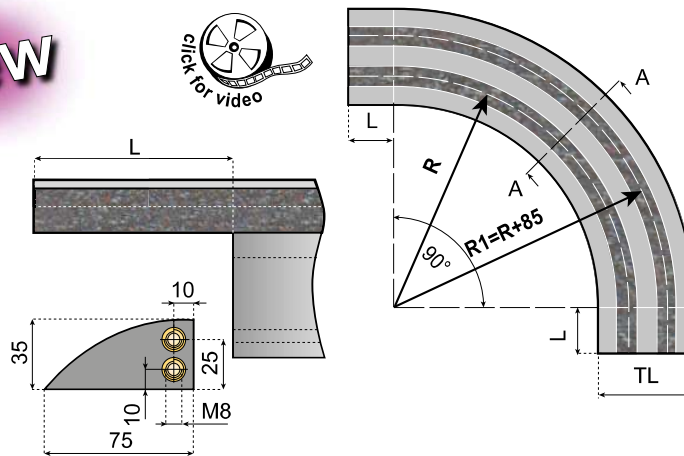

i Introduction to curves. Go to: **50005a**

Replacement **50565a**

TOPTRAC
- Replaceable wearstrips
- Lowest coefficient of friction
50006a

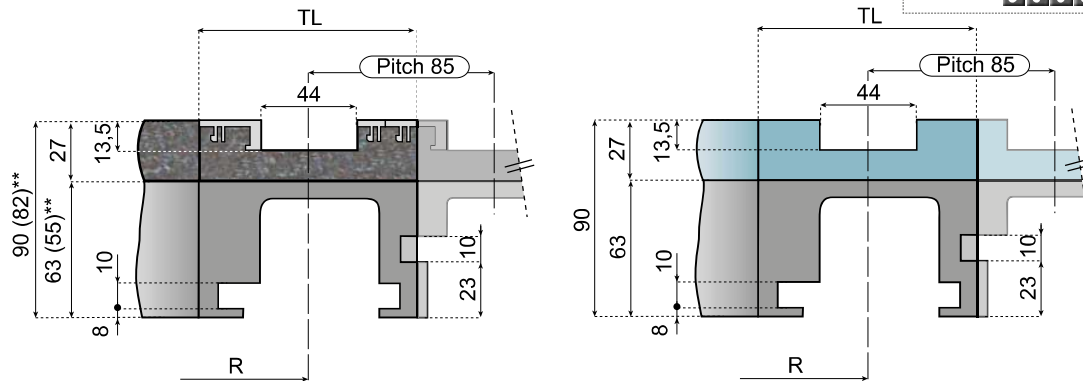

**Dimensions (...) are for 1 - Track version serie KB7.

TRACKS NR.	TL	TYPE CURVE	R	L	TOPTRAC®			STANDARD		
					ITEM DESCRIPTION			ITEM DESCRIPTION		
					30°	45°	90°	30°	45°	90°
					PLATE: K330-WIDTH: 83,8 mm P=85					
1	100	KB7**	500	0	TTM90-30-01A	TTM90-45-01A	TTM90-90-01A	KMD90-30-01A	KMD90-45-01A	KMD90-90-01A
2	185				TTM90-30-02A	TTM90-45-02A	TTM90-90-02A	KMD90-30-02A	KMD90-45-02A	KMD90-90-02A
3	270				TTM90-30-03A	TTM90-45-03A	TTM90-90-03A	KMD90-30-03A	KMD90-45-03A	KMD90-90-03A
4	355				TTM90-30-04A	TTM90-45-04A	TTM90-90-04A	KMD90-30-04A	KMD90-45-04A	KMD90-90-04A
5	440				TTM90-30-05A	TTM90-45-05A	TTM90-90-05A	KMD90-30-05A	KMD90-45-05A	KMD90-90-05A
6	525				TTM90-30-06A	TTM90-45-06A	TTM90-90-06A	KMD90-30-06A	KMD90-45-06A	KMD90-90-06A
1	100	KB6	500	100	TTM91-30-01B	TTM91-45-01B	TTM91-90-01B	KMD91-30-01B	KMD91-45-01B	KMD91-90-01B
2	185				TTM91-30-02B	TTM91-45-02B	TTM91-90-02B	KMD91-30-02B	KMD91-45-02B	KMD91-90-02B
3	270				TTM91-30-03B	TTM91-45-03B	TTM91-90-03B	KMD91-30-03B	KMD91-45-03B	KMD91-90-03B
4	355				TTM91-30-04B	TTM91-45-04B	TTM91-90-04B	KMD91-30-04B	KMD91-45-04B	KMD91-90-04B
5	440				TTM91-30-05B	TTM91-45-05B	TTM91-90-05B	KMD91-30-05B	KMD91-45-05B	KMD91-90-05B
6	525				TTM91-30-06B	TTM91-45-06B	TTM91-90-06B	KMD91-30-06B	KMD91-45-06B	KMD91-90-06B
7	610				TTM91-30-07B	TTM91-45-07B	TTM91-90-07B	KMD91-30-07B	KMD91-45-07B	KMD91-90-07B
8	695				TTM91-30-08B	TTM91-45-08B	TTM91-90-08B	KMD91-30-08B	KMD91-45-08B	KMD91-90-08B
1	100	KB8	750	100	TTM93-30-01B	TTM93-45-01B	TTM93-90-01B	KMD93-30-01B	KMD93-45-01B	KMD93-90-01B
2	185				TTM93-30-02B	TTM93-45-02B	TTM93-90-02B	KMD93-30-02B	KMD93-45-02B	KMD93-90-02B
1	111	KB4	500	100	TTM92-30-01B	TTM92-45-01B	TTM92-90-01B	KMD92-30-01B	KMD92-45-01B	KMD92-90-01B
2	196				TTM92-30-02B	TTM92-45-02B	TTM92-90-02B	KMD92-30-02B	KMD92-45-02B	KMD92-90-02B
3	281				TTM92-30-03B	TTM92-45-03B	TTM92-90-03B	KMD92-30-03B	KMD92-45-03B	KMD92-90-03B
4	366				TTM92-30-04B	TTM92-45-04B	TTM92-90-04B	KMD92-30-04B	KMD92-45-04B	KMD92-90-04B
1	100	KB5D	1000	0	TTM96-30-01A	TTM96-45-01A	TTM96-90-01A	KMD96-30-01A	KMD96-45-01A	KMD96-90-01A

• More tracks and different angles available on request.

Chains & sprockets	Wear strips	Side guide brackets & accessories	Levelers	Engineering manual
Modular belts & sprockets	Chain & belt return systems	Frame & structure supports	Bearing supports	
Curves & tracks	Side guide solutions	Miscellaneous products	Equipment	

50101a

MAGNETIC CURVES FOR CHAINBELT 2251M / K330-450

www.SystemPlastSmartGuide.com

RADIUS 500-610-750-1000 / BASIC WIDTH: 100, 111 AND 129

For general index, go to:

50010a

New



For sideflexing chainbelts, type: **2251 M**

Go to:

30700a

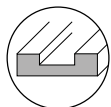

For straight curve go to:

50140a

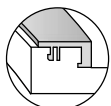

For type curve: **KC4**

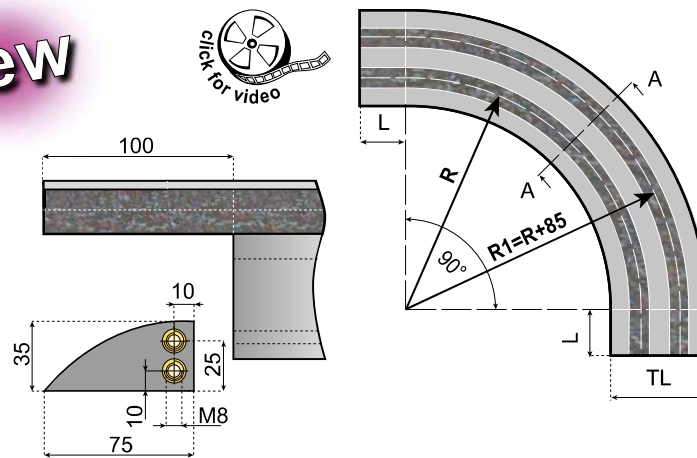

Introduction to curves. Go to: **50005a**

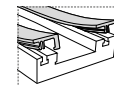

Replacement

50565a

TOPTRAC

- Replaceable wearstrips
- Lowest coefficient of friction

50006a

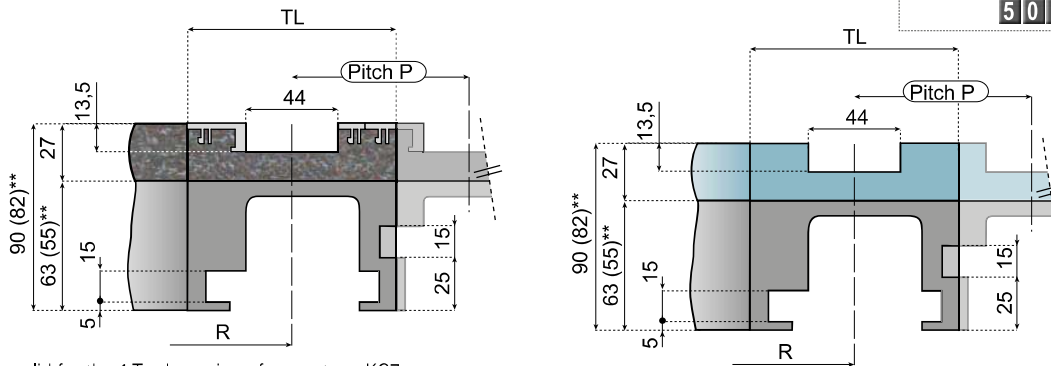

**Dimensions (...) are valid for the 1 Track version of curve type KC7.

TRACKS NR.	TL	TYPE CURVE	R	L	PITCH	TOPTRAC®			STANDARD		
						ITEM DESCRIPTION			ITEM DESCRIPTION		
						30°	45°	90°	30°	45°	90°
						PLATE: K330-WIDTH: 83,8 mm			PLATE: K330-WIDTH: 83,8 mm		
1	100	KC7**	500	0	85	TTM84-30-01A	TTM84-45-01A	TTM84-90-01A	KMD84-30-01A	KMD84-45-01A	KMD84-90-01A
2	185					TTM84-30-02A	TTM84-45-02A	TTM84-90-02A	KMD84-30-02A	KMD84-45-02A	KMD84-90-02A
3	270					TTM84-30-03A	TTM84-45-03A	TTM84-90-03A	KMD84-30-03A	KMD84-45-03A	KMD84-90-03A
4	355					TTM84-30-04A	TTM84-45-04A	TTM84-90-04A	KMD84-30-04A	KMD84-45-04A	KMD84-90-04A
5	440					TTM84-30-05A	TTM84-45-05A	TTM84-90-05A	KMD84-30-05A	KMD84-45-05A	KMD84-90-05A
6	525					TTM84-30-06A	TTM84-45-06A	TTM84-90-06A	KMD84-30-06A	KMD84-45-06A	KMD84-90-06A
7	610					TTM84-30-07A	TTM84-45-07A	TTM84-90-07A	KMD84-30-07A	KMD84-45-07A	KMD84-90-07A
8	695					TTM84-30-08A	TTM84-45-08A	TTM84-90-08A	KMD84-30-08A	KMD84-45-08A	KMD84-90-08A
1	100	KC6	500	100	85	TTM85-30-01B	TTM85-45-01B	TTM85-90-01B	KMD85-30-01B	KMD85-45-01B	KMD85-90-01B
2	185					TTM85-30-02B	TTM85-45-02B	TTM85-90-02B	KMD85-30-02B	KMD85-45-02B	KMD85-90-02B
3	270					TTM85-30-03B	TTM85-45-03B	TTM85-90-03B	KMD85-30-03B	KMD85-45-03B	KMD85-90-03B
4	355					TTM85-30-04B	TTM85-45-04B	TTM85-90-04B	KMD85-30-04B	KMD85-45-04B	KMD85-90-04B
5	440					TTM85-30-05B	TTM85-45-05B	TTM85-90-05B	KMD85-30-05B	KMD85-45-05B	KMD85-90-05B
6	525					TTM85-30-06B	TTM85-45-06B	TTM85-90-06B	KMD85-30-06B	KMD85-45-06B	KMD85-90-06B
1	111	KC4	500	100	85	TTM86-30-01B	TTM86-45-01B	TTM86-90-01B	KMD86-30-01B	KMD86-45-01B	KMD86-90-01B
2	196					TTM86-30-02B	TTM86-45-02B	TTM86-90-02B	KMD86-30-02B	KMD86-45-02B	KMD86-90-02B
3	281					TTM86-30-03B	TTM86-45-03B	TTM86-90-03B	KMD86-30-03B	KMD86-45-03B	KMD86-90-03B
4	366					TTM86-30-04B	TTM86-45-04B	TTM86-90-04B	KMD86-30-04B	KMD86-45-04B	KMD86-90-04B
5	451					TTM86-30-05B	TTM86-45-05B	TTM86-90-05B	KMD86-30-05B	KMD86-45-05B	KMD86-90-05B
6	536					TTM86-30-06B	TTM86-45-06B	TTM86-90-06B	KMD86-30-06B	KMD86-45-06B	KMD86-90-06B
1	100	KC8	750	100	-	TTM87-30-01B	TTM87-45-01B	TTM87-90-01B	KMD87-30-01B	KMD87-45-01B	KMD87-90-01B
1	100	KC5D	1000	0	-	TTM97-30-01A	TTM97-45-01A	TTM97-90-01A	KMD97-30-01A	KMD97-45-01A	KMD97-90-01A
						PLATE: K450-WIDTH: 114,3 mm			PLATE: K450-WIDTH: 114,3 mm		
1	129	KC22	500	100	-	TTM64-30-01B	TTM64-45-01B	TTM64-90-01B	KMD64-30-01B	KMD64-45-01B	KMD64-90-01B
1	129	KC27	610	100	117	TTM66-30-01B	TTM66-45-01B	TTM66-90-01B	KMD66-30-01B	KMD66-45-01B	KMD66-90-01B
2	246					-	-	-	KMD66-30-02B	KMD66-45-02B	KMD66-90-02B

• More tracks and different angles available on request.

Chains & sprockets	Wear strips	Side guide brackets & accessories	Levelers	Engineering manual
Modular belts & sprockets	Chain & belt return systems	Frame & structure supports	Bearing supports	
Curves & tracks	Side guide solutions	Miscellaneous products	Equipment	

5 0 1 1 0 a

CURVES AND STRAIGHT TRACKS FOR TAB CHAINS

www.SystemPlastSmartGuide.com

For general index, go to:

5 0 0 1 0 b

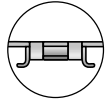

For steel chains, type:
881R TAB - 881O TAB

Go to:

1 1 0 7 0 a

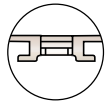

For plastic chains, type:
877 TAB • 878 TAB
879 TAB • 880 TAB

Go to:

1 1 2 3 0 a

2250 TAB • 2251 TAB

Go to:

3 0 7 1 0 a



Introduction to curves. Go to:

5 0 0 0 5 a

CURVE TRACKS

CHAIN TYPES 877/878/879/880/881O-TAB K325-330-450-750
CHAINBELT TYPES 2250/2251 TAB K330-K450

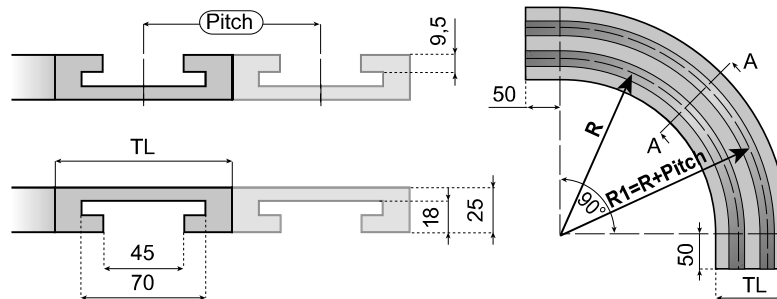

REFERENCE	PITCH	TRACKS	TL	R 500	R 610	R 650	R 800
				ITEM DESCRIPTION			
880TAB-K325 880TAB-K330 2250 TAB K330 2251 TAB K330	85	1	100	VT880T325R500T1D	VT880T325R610T1D	VT880T325R650T1D	VT880T325R800T1D
		2	185	VT880T325R500T2D	-	-	-
		3	270	VT880T325R500T3D	-	-	-
		4	355	VT880T325R500T4D	-	-	-
880TAB-K450 2251TAB-K450	120	1	130	-	VT880T450R610T1D	VT880T450R650T1D	VT880T450R800T1D
		2	250	-	VT880T450R610T2D	-	-
880TAB-K750	195	1	200	-	VT880T750R610T1D	-	VT880T750R800T1D

Supply: complete set - carry+return. Material: UHMWPE; color: black.

STRAIGHT TRACKS

CHAIN TYPES 815 TAB VG/877/878/879/880/881O-TAB K325-330-450-750
CHAINBELT TYPES 2250/2251 TAB K330-K450

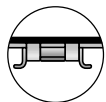

For steel chains, type:
815 TAB VG

Go to:

1 1 1 5 0 a

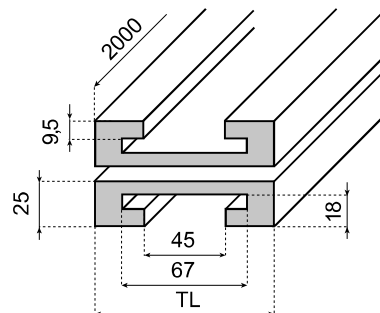

Carry/Return straight track sections

REFERENCE	TL	ITEM DESCRIPTION
K325	100	VT880T325L2000T1
K450	130	VT880T450L2000T1
K750	200	VT880T750L2000T1

Supply: 1 piece.
Material: UHMWPE; color: black.

Chains & sprockets	Wear strips	Side guide brackets & accessories	Levelers	Engineering manual
Modular belts & sprockets	Chain & belt return systems	Frame & structure supports	Bearing supports	
Curves & tracks	Side guide solutions	Miscellaneous products	Equipment	

5 0 1 2 0 a

COMPACT CURVES AND STRAIGHT TRACKS FOR TAB CHAINS

www.SystemPlastSmartGuide.com

For general index, go to:

5 0 0 1 0 b

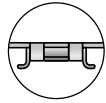

For steel chains, type:
881R TAB - 8810 TAB
Go to:

1 1 0 7 0 a

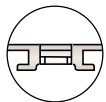

For plastic chains, type:
877 TAB • 878 TAB
879 TAB • 880 TAB
Go to:

1 1 2 3 0 a

2250 TAB • 2251 TAB
Go to:

3 0 7 1 0 a

CURVE TRACKS

CHAIN TYPES 877/878/879/880/8810-TAB K325-330-450-750

CHAINBELT TYPES 2250/2251 TAB K330-K450

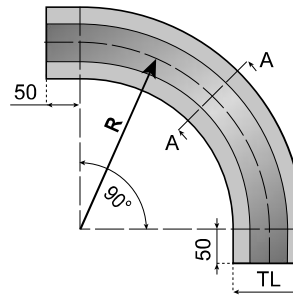
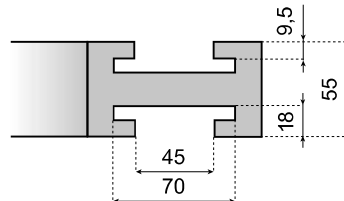

Compact curve tracks

REFERENCE	TL	ITEM DESCRIPTION	RADIUS R
880TAB-K325 880TAB-K330 2250 TAB K330 2251 TAB K330	100	VTC880T325R500T1D	500
880TAB-K450 2251TAB-K450	130	VTC880T450R610T1D	610

Supply: 1 piece.
Material: UHMWPE; color: black.



Introduction to curves. Go to:

5 0 0 0 5 a

STRAIGHT TRACKS

CHAIN TYPES 815 TAB VG/877/878/879/880/8810-TAB K325-330-450-750

CHAINBELT TYPES 2250/2251 TAB K330-K450



For steel chains, type:
815 TAB VG
Go to:

1 1 1 5 0 a

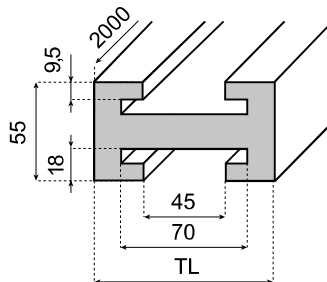

Compact straight track sections

REFERENCE	TL	ITEM DESCRIPTION
K325	100	VTC880T325L2000T1
K450	130	VTC880T450L2000T1

Supply: 1 piece.
Material: UHMWPE; color: black.

COMPACT CORNER TRACK FOR BEVEL CHAINS

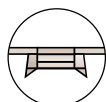

For bevel chains, type:
8810
Go to:

1 1 0 8 0 a

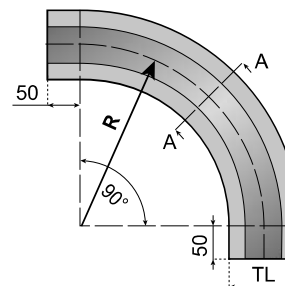
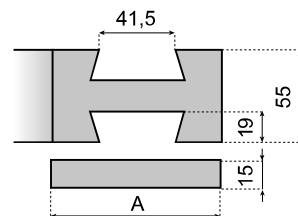

REFERENCE	TRACKS	TL	ITEM DESCRIPTION	RADIUS R
K325	1	100	VTC880B325R500T1D	500

Supply: 2 pieces (including return plate).
Material: UHMWPE; color: black.

Chains & sprockets	Wear strips	Side guide brackets & accessories	Levelers	Engineering manual
Modular belts & sprockets	Chain & belt return systems	Frame & structure supports	Bearing supports	
Curves & tracks	Side guide solutions	Miscellaneous products	Equipment	

5 0 1 3 0 a

CURVES AND STRAIGHT TRACKS FOR BEVEL CHAINS

www.SystemPlastSmartGuide.com

CHAIN TYPES 879/880/8810 - K325-350-450-750

For general index, go to:

5 0 0 1 0 b



For Stainless steel bevel chains, type: **881R - 8810**

Go to:

1 1 0 8 0 a



For plastic bevel chains, type: **879 - 880**

Go to:

1 1 2 4 0 a



Introduction to curves. Go to:

5 0 0 0 5 a

CURVE TRACKS

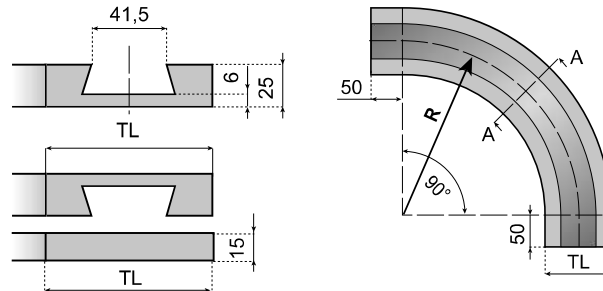

REFERENCE	TRACKS	TL WIDTH mm	R 500	R 610
880-K325	1	100	VT880B325R500T1D	VT880B325R610T1D
880-K450	1	130	-	VT880B450R610T1D
880-K750	1	200	-	VT880B750R610T1D

Supply: complete set - carry+return.
Material: UHMWPE; color: black.

STRAIGHT TRACKS

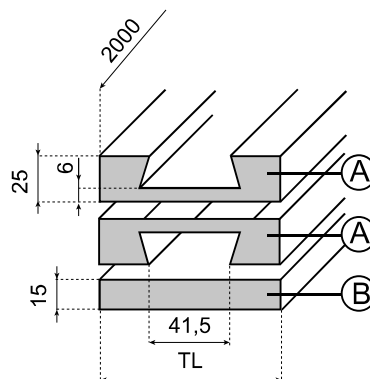

Information about this product is only available on our Smart Guide® website.

A

CARRY/RETURN STRAIGHT TRACK SECTIONS

REFERENCE	TL	ITEM DESCRIPTION
K325	100	VT880B325L2000T1
K450	130	VT880B450L2000T1
K750	200	VT880B750L2000T1

Supply: 1 piece.
Material: UHMWPE; color: black.

B

RETURN TRACK SECTIONS

REFERENCE	TL	ITEM DESCRIPTION
K325	100	VTR880B325L2000T1
K450	130	For these support plates go to: 5 0 1 5 0 a
K750	200	(types VTR882B450&750)

Supply: 1 piece.
Material: UHMWPE; color: black.

Chains & sprockets	Wear strips	Side guide brackets & accessories	Levelers	Engineering manual
Modular belts & sprockets	Chain & belt return systems	Frame & structure supports	Bearing supports	
Curves & tracks	Side guide solutions	Miscellaneous products	Equipment	

5 0 1 4 0 a CURVES AND STRAIGHT TRACKS FOR TAB AND MAGNETIC CHAINS

www.SystemPlastSmartGuide.com

CHAIN TYPES 882-TAB-K450-750-1000-1200

For general index, go to:

5 0 0 1 0 b



For plastic chains, type:

882 TAB

Go to:

1 1 2 9 0 a



Introduction to curves. Go to:

5 0 0 0 5 a

CURVE TRACKS

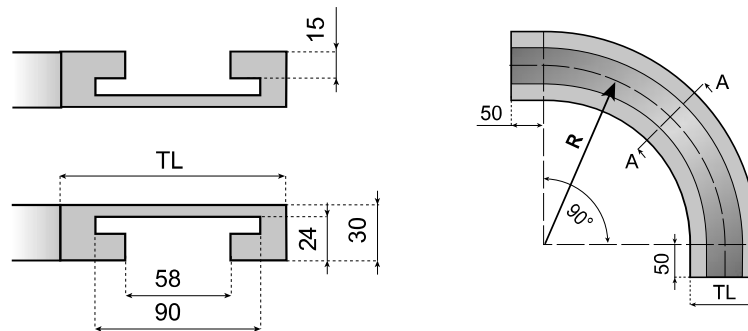

REFERENCE	TL WIDTH mm	R 610	R 650	R 800	R 1000
882TAB-K450	130	VT882T450R610T1D	VT882T450R650T1D	VT882T450R800T1D	-
882TAB-K750	200	VT882T750R610T1D	VT882T750R650T1D	VT882T750R800T1D	VT882T750R1000T1D
882TAB-K1000	270	VT882T1000R610T1D	VT882T1000R650T1D	VT882T1000R800T1D	VT882T1000R1000T1D
882TAB-K1200	320	VT882T1200R610T1D	VT882T1200R650T1D	VT882T1200R800T1D	VT882T1200R1000T1D

Supply: complete set - carry+return.

Material: UHMWPE; color: black.

STRAIGHT TRACKS

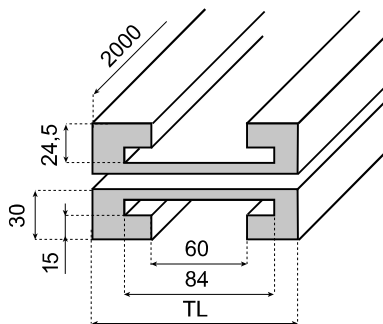

Straight track sections

CHAINS REF.	TL	ITEM DESCRIPTION
K450	130	VT882T450L2000T1
K750	200	VT882T750L2000T1
K1000	270	VT882T1000L2000T1
K1200	320	VT882T1200L2000T1

Supply: 1 piece.

Material: UHMWPE; color: black.

STRAIGHT TRACKS

CHAIN TYPES 879M/880M/881M-K325-330/2250M/2251M/2260M-K330

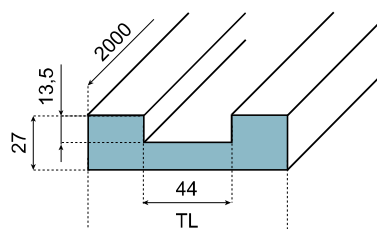

Straight track sections

CHAINS REF.	TL	ITEM DESCRIPTION
K325/K330	100	VTO880M325L2000T1

Supply: 1 piece.

Material: UHMWPE; color: water blue.

Suitable with magnetic curves:

879M-880M-881M

5 0 0 2 0 a

5 0 0 3 0 a

879M-880M-881M

5 0 0 5 0 a

LBP 879M

5 0 0 7 0 a

2250M-2260M

5 0 0 9 1 a

2251M

5 0 1 0 1 a

Chains & sprockets	Wear strips	Side guide brackets & accessories	Levelers	Engineering manual
Modular belts & sprockets	Chain & belt return systems	Frame & structure supports	Bearing supports	
Curves & tracks	Side guide solutions	Miscellaneous products	Equipment	

5 0 1 4 0 z

APPLICATION EXAMPLES

www.SystemPlastSmartGuide.com

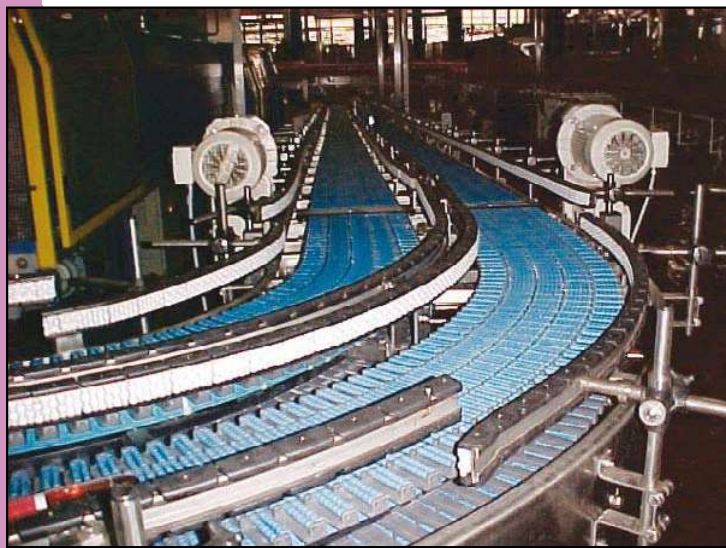

SIDE FLEXING LBP CHAINS IN COMBINATION WITH ROLLER SIDE GUIDES.

LBP chains, go to:

1 1 0 1 2 a

Roller side guides, go to:

5 2 5 1 0 a



SPEEDLINE STAINLESS STEEL CHAINS IN COMBINATION WITH MAGNETIC CURVES.

Side flexing Speedline chains, go to:

1 1 0 6 0 a

Magnetic curves, go to:

5 0 0 1 0 a

Chains & sprockets	Wear strips	Side guide brackets & accessories	Levelers	Engineering manual
Modular belts & sprockets	Chain & belt return systems	Frame & structure supports	Bearing supports	
Curves & tracks	Side guide solutions	Miscellaneous products	Equipment	

5 0 1 5 0 a

CURVES AND STRAIGHT TRACKS FOR BEVEL CHAINS

www.SystemPlastSmartGuide.com

CHAIN TYPES 882K450-750-1200

For general index, go to:

5 0 0 1 0 b



For plastic bevel chains, type: **882**

Go to:

1 1 2 9 0 a



Introduction to curves. Go to:

5 0 0 0 5 a

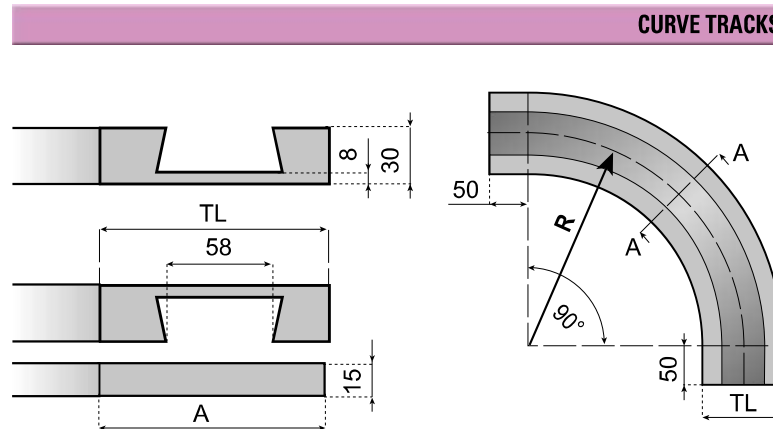

REFERENCE	TL WIDTH	R 610	R 650	R 800	R 1000
K450	130	VT882B450R610T1D	VT882B450R650T1D	VT882B450R800T1D	VT882B450R1000T1D
K750	200	VT882B750R610T1D	VT882B750R650T1D	VT882B750R800T1D	VT882B750R1000T1D
K1000	270	VT882B1000R610T1D	VT882B1000R650T1D	VT882B1000R800T1D	VT882B1000R1000T1D

Supply: complete set - carry+return.
Material: UHMWPE; color: black.

STRAIGHT TRACKS

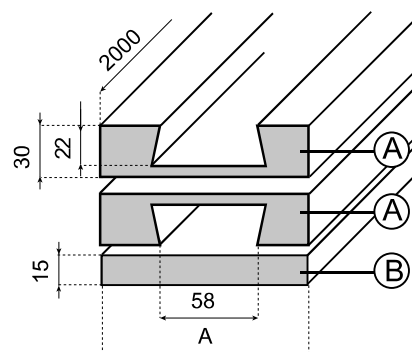

(A)

Carry/Return straight track sections

REFERENCE	TL	ITEM DESCRIPTION
K450	130	VT882B450L2000T1
K750	200	VT882B750L2000T1
K1000	270	VT882B1000L2000T1

Supply: 1 piece.
Material: UHMWPE; color: black.

(B)

Return track sections

REFERENCE	TL	ITEM DESCRIPTION
K450	100	VTR882B450L2000T1
K750	130	VTR882B750L2000T1
K1000	200	VTR882B1000L2000T1

Supply: 1 piece.
Material: UHMWPE; color: black.

Chains & sprockets	Wear strips	Side guide brackets & accessories	Levelers	Engineering manual
Modular belts & sprockets	Chain & belt return systems	Frame & structure supports	Bearing supports	
Curves & tracks	Side guide solutions	Miscellaneous products	Equipment	

5 0 1 6 0 a

CURVES AND STRAIGHT TRACKS FOR TAB CHAINS

www.SystemPlastSmartGuide.com

CHAIN TYPES 1863-1873-1874

For general index, go to:

5 0 0 1 0 b

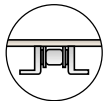

For plastic chains, type:

1873

Go to:

1 1 4 7 0 a



For steel chains, type:

1874

Go to:

1 1 1 4 0 a

CURVE TRACKS

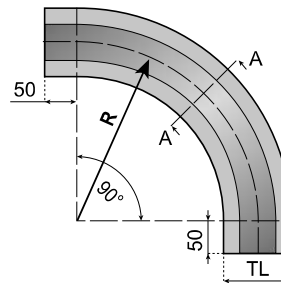
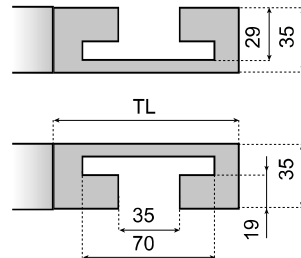

Introduction to curves. Go to:

5 0 0 0 5 a

TAB CHAINS	TL WIDTH mm	R1 380	R1 500	R1 610	R1 800	R1 1000
1863-1873 1874TAB-K225	75	VT1873T225R380T1D	VT1873T225R500T1D	VT1873T225R610T1D	VT1873T225R800T1D	VT1873T225R1000T1D
1873 1874TAB-K325	100	VT1873T325R380T1D	VT1873T325R500T1D	VT1873T325R610T1D	VT1873T325R800T1D	VT1873T325R1000T1D
1873TAB-K450	130	VT1873T450R380T1D	VT1873T450R500T1D	VT1873T450R610T1D	VT1873T450R800T1D	VT1873T450R1000T1D
1873TAB-K600	170	-	VT1873T600R500T1D	VT1873T600R610T1D	VT1873T600R800T1D	VT1873T600R1000T1D
1873TAB-K750	170	-	VT1873T750R500T1D	VT1873T750R610T1D	VT1873T750R800T1D	VT1873T750R1000T1D
1873TAB-K1000	270	-	VT1873T1000R500T1D	VT1873T1000R610T1D	VT1873T1000R800T1D	VT1873T1000R1000T1D
1873TAB-K1200	320	-	-	VT1873T1200R610T1D	VT1873T1200R800T1D	VT1873T1200R1000T1D

Supply: complete set - carry+return.

Material: UHMWPE; color: black.

STRAIGHT TRACKS

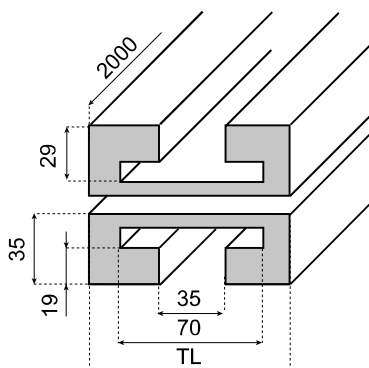

Carry/Return straight track sections

CHAINS REF.	TL	ITEM DESCRIPTION
K325	100	VT1873T325L2000T1
K450	130	VT1873T450L2000T1
K600	170	VT1873T600L2000T1
K750	200	VT1873T750L2000T1
K1000	270	VT1873T1000L2000T1
K1200	320	VT1873T1200L2000T1

Supply: 1 piece.

Material: UHMWPE; color: black.

Chains & sprockets	Wear strips	Side guide brackets & accessories	Levelers	Engineering manual
Modular belts & sprockets	Chain & belt return systems	Frame & structure supports	Bearing supports	
Curves & tracks	Side guide solutions	Miscellaneous products	Equipment	



5 0 1 7 0 a

CURVES FOR MULTIFLEX CHAINS

www.SystemPlastSmartGuide.com

For general index, go to:

5 0 0 1 0 b

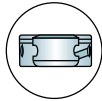

For plastic chains, type: **1701 TAB**

Go to:

1 1 5 3 0 a

CURVE TRACKS

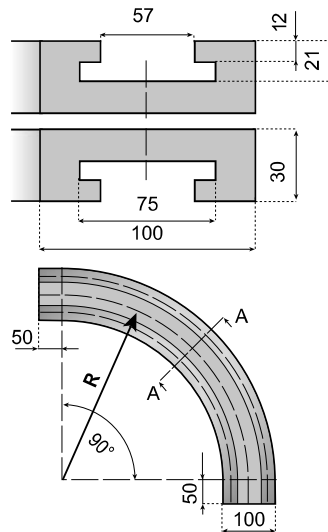

Supply: complete set - carry+return.
Material: UHMWPE; color: black.

CHAIN TYPE	R	ITEM DESCRIPTION
1701TAB	250	VT1701T-R250T1D
	500	VT1701T-R500T1D

STRAIGHT TRACKS

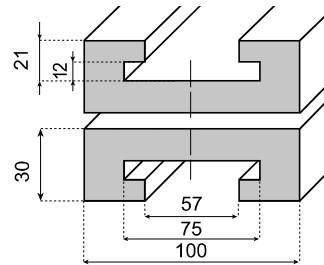

Supply: 1 piece.
Material: UHMWPE; color: black.

CHAIN TYPE	ITEM DESCRIPTION
1701TAB	VT1701T-L2000T1

APPLICATION

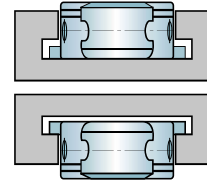

CURVE TRACKS

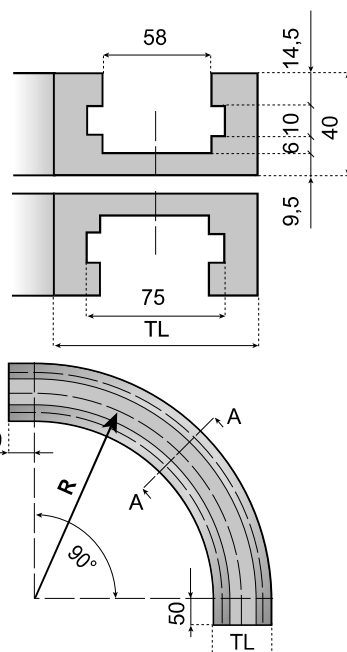

For plastic chains, type: **1710-CTAB**

Go to:

1 1 5 4 0 a

STRAIGHT TRACKS

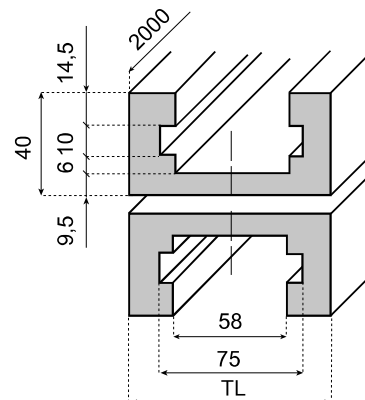

APPLICATION

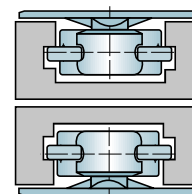

Curves for multiflex TAB chains - Type H

CHAIN TYPE	PLATE WIDTH	TL	R	ITEM DESCRIPTION
1710CTAB-K375	95	110	250	VT1710CT375R250T1D
1710CTAB-K750	190	200	500	VT1710CT750R500T1D

Carry/Return track sections

Supply: 1 piece.
Material: UHMWPE; color: black.

CHAIN TYPE	PLATE WIDTH	TL	ITEM DESCRIPTION
1710CTAB-K375	95	110	VT1710CT375L2000T1
1710CTAB-K750	190	200	VT1710CT750L2000T1

Chains & sprockets	Wear strips	Side guide brackets & accessories	Levelers	Engineering manual
Modular belts & sprockets	Chain & belt return systems	Frame & structure supports	Bearing supports	
Curves & tracks	Side guide solutions	Miscellaneous products	Equipment	



5 0 1 8 0 a

CURVES FOR MULTIFLEX TOP PLATES

www.SystemPlastSmartGuide.com

For general index, go to:

5 0 0 1 0 b

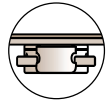

For plastic chains, type:
1713-CTAB

Go to:

1 1 5 4 0 a

CURVE TRACKS

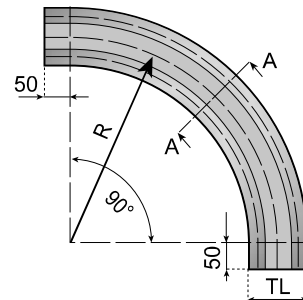
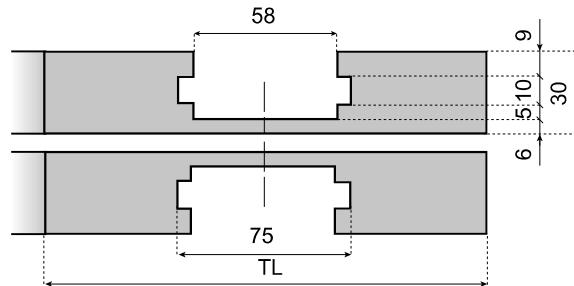

APPLICATION

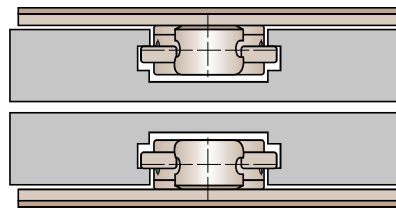

Introduction to curves. Go to:

5 0 0 0 5 a

Curves for multiflex TAB chains - Type P
Material: UHMWPE; color: black.

Supply: complete set - carry+return.

CHAIN TYPE	PLATE WIDTH	TL	R	ITEM DESCRIPTION
1713CTAB-K750	191	200	550	VT1713CT750R550T1D
1713CTAB-K1000	254	270	550	VT1713CT1000R550T1D

STRAIGHT TRACKS

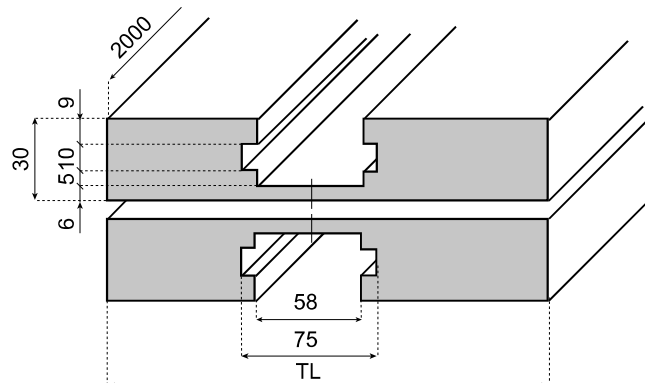

Carry/Return track sections - 1 Piece
Material: UHMWPE; color: black.

CHAIN TYPE	PLATE WIDTH	TL	ITEM DESCRIPTION
1713CTAB-K750	191	200	VT1713CT750L2000T1
1713CTAB-K1000	254	270	VT1713CT1000L2000T1

Chains & sprockets	Wear strips	Side guide brackets & accessories	Levelers	Engineering manual
Modular belts & sprockets	Chain & belt return systems	Frame & structure supports	Bearing supports	
Curves & tracks	Side guide solutions	Miscellaneous products	Equipment	

7 3 5 4 7 a

BEARING AND SHAFT

BEARING

SHAFT SIZE:

THE SHAFT MUST FULFILL THE FOLLOWING CONDITIONS:

- Maximum shaft deflection F_{max} under full load (F_w) is 2,5 mm (0.10 in). If the calculated shaft deflection exceeds this max value, select a bigger shaft size or install an intermediate supported bearing on the shaft.
- Torque (**Ts**) at maximum load must be below critical value;
Shaft maximum deflection under concentrated load applied in the center can be calculated with following formula:

2 BEARINGS

$$f = \frac{5}{384} * F_w \frac{l_b^3}{E * I} \text{ [mm]: } F_w \text{ [N], } l_b \text{ [mm], } I \text{ [mm}^4\text{], } E \left[\frac{\text{N}}{\text{mm}^2} \right]$$

$$f = \frac{5}{384} * F_w \frac{l_b^3}{E * I} \text{ [in]: } F_w \text{ [lb], } l_b \text{ [in], } I \text{ [in}^4\text{], } E \left[\frac{\text{lb}}{\text{in}^2} \right]$$

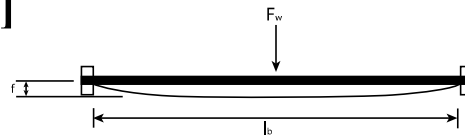

3 BEARINGS

$$f = \frac{1}{370} * F_w \frac{l_b^3}{E * I} \text{ [mm]: } F_w \text{ [N], } l_b \text{ [mm], } I \text{ [mm}^4\text{], } E \left[\frac{\text{N}}{\text{mm}^2} \right]$$

$$f = \frac{1}{370} * F_w \frac{l_b^3}{E * I} \text{ [in]: } F_w \text{ [lb], } l_b \text{ [in], } I \text{ [in}^4\text{], } E \left[\frac{\text{lb}}{\text{in}^2} \right]$$

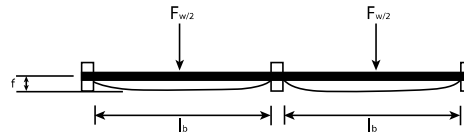

For uni-directional head drive $F_w = T$,

For bi-directional center drive $F_w = 2 * T$,

For uni-directional pusher drives $F_w = 2.2 * T$,

For modulus of elasticity (E) use: 200,000 N/mm² or 28,500,000 lb/in². Values are for carbon steel (C50) or stainless steel AISI 304/316. Modulus of elasticity for other materials can be referenced via industry standards.

MOMENT OF INERTIA FOR SOLID SHAFTS (I)			
SHAFT SIZE		INERTIA	
mm	in.	mm ⁴	in ⁴
SQUARE SHAFTS			
25	-	32552	-
40	-	213333	-
60	-	1080000	-
90	-	5467500	-

MOMENT OF INERTIA FOR SOLID SHAFTS (I)			
SHAFT SIZE		INERTIA	
mm	in.	mm ⁴	in ⁴
ROUND SHAFTS			
20	-	7850	-
25	-	19150	-
30	-	39750	-
35	-	73650	-
40	-	125600	-
45	-	201200	-
50	-	306650	-
55	-	449000	-
60	-	635850	-
80	-	2009600	-
90	-	3220000	-
-	1	-	0.049
-	1.1875	-	0.098
-	1.25	-	0.120
-	1.4375	-	0.210
-	1.5	-	0.248

Moment of inertia can be calculated for all shaft diameter and shape. It's a geometrical property of the shaft.

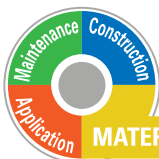

MATERIALS AND CALCULATIONS - General index **7 3 5 1 0 a**

continue ►

7 3 5 4 2 a Bearing selection

7 3 5 2 2 a Pressure of accumulation products

7 3 5 2 8 a 2500RR calculations

7 3 5 1 5 a Product handling

7 3 5 2 4 a 90° product transfer with belts

7 3 5 3 3 a 2253RTC calculations

7 3 5 1 9 a Product handling maximum acceleration

7 3 5 2 6 a Thermal expansion

7 3 5 7 8 a Coefficient of friction of standard materials



Chains & sprockets	Wear strips	Side guide brackets & accessories	Levelers	Engineering manual
Modular belts & sprockets	Chain & belt return systems	Frame & structure supports	Bearing supports	
Curves & tracks	Side guide solutions	Miscellaneous products	Equipment	

7 3 5 4 8 a

BEARING AND SHAFT

BEARING

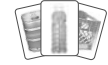

◀ back continue ▶

BEARING CALCULATIONS FOR SERIES UC AND UF:

STATIC LOAD CALCULATION:

In case the bearing is loaded without rotating, very slowly rotating or is making a slow oscillating movement, the bearing power is not determined by the fatigue life of the material but by the deformation of the rollers and the groove. This calculation is also valid if at a fraction of the rotation a shock load is present.

$$P_0 = X_0 * F_r + Y_0 * F_a = 0.6 * F_r + 0.5 * F_a$$

P_0 equivalent static load [N];

X_0 radial static factor;

F_r radial load [N];

Y_0 axial static factor;

F_a axial load [N];

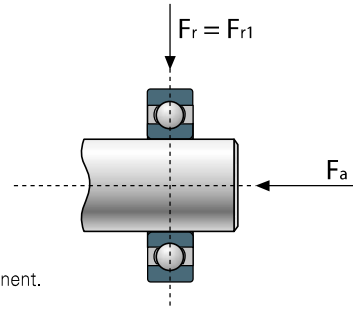

Bearing mounting.
Go to:

7 3 0 5 2 a

P_0 is calculated when there is not only a radial component in the load but also an axial component.

When the load on the bearing is strictly radial the equivalent static load $P_0 = F_r$.

The minimum static load coefficient C_0 is calculated while taking into account the static safety factor S_0 .

Then in the bearing tables the right size bearing can be found checking the C_a .

$$C_0 = S_0 * P_0$$

C_0 static load coefficient in [N]

S_0 static safety factor;

$S_0 = 1$ for normal circumstances,

= 1.5 when vibrations are involved and

= 2 - 2.5 for noiseless applications.

DYNAMIC LOAD CALCULATION:

For normal circumstances, the dynamic load coefficient is calculated and compared to the equivalent dynamic load to determine the theoretical service life of the bearing. The calculated service life is then compared to the standard for the application and industry.

$$L_{10} = \left(\frac{C}{P} \right)^3$$

L_{10} = nominal life time in millions of revolutions
 C = dynamic load coefficient in [N]
 P = equivalent dynamic load [N]

When bearings run at constant speed, their life can be determined in working hours:

$$L_{10h} = \frac{1.000.000}{60n} * \left(\frac{C}{P} \right)^3$$

L_{10h} = life in hours.
 n = speed [rpm].

When the load on the bearing is strictly radial the equivalent dynamic load $P = F_r$.

When there's also an axial load involved the equivalent dynamic load is:

$$P = X * F_r + Y * F_a$$



MATERIALS AND CALCULATIONS - General index 7 3 5 1 0 a -

◀ back continue ▶

7 3 5 4 2 a Bearing selection

7 3 5 2 2 a Pressure of accumulation products

7 3 5 2 8 a 2500RR calculations

7 3 5 1 5 a Product handling

7 3 5 2 4 a 90° product transfer with belts

7 3 5 3 3 a 2253RTC calculations

7 3 5 1 9 a Product handling maximum acceleration

7 3 5 2 6 a Thermal expansion

7 3 5 7 8 a Coefficient of friction of standard materials



Chains & sprockets	Wear strips	Side guide brackets & accessories	Levelers	Engineering manual
Modular belts & sprockets	Chain & belt return systems	Frame & structure supports	Bearing supports	
Curves & tracks	Side guide solutions	Miscellaneous products	Equipment	

7 3 5 4 9 a

BEARING AND SHAFT

BEARING



X radial dynamic factor;

Y axial dynamic factor;

The axial force only influences the equivalent dynamic load when $F_a / F_r > E$

◀ back continue ▶

CALCULATION FACTORS					
F_a / C_0	E	$F_a / F_r < E$		$F_a / F_r > E$	
		X	Y	X	Y
0.025	0.22	1	0	0.56	2
0.04	0.24	1	0	0.56	1.8
0.07	0.27	1	0	0.56	1.6
0.13	0.31	1	0	0.56	1.4
0.25	0.37	1	0	0.56	1.2
0.5	0.44	1	0	0.56	1

Bearing mounting.
Go to:

7 3 0 5 2 a

THE AXIAL LOAD SHOULD NEVER EXCEED 20% OF THE DYNAMIC LOAD COEFFICIENT (C).

INDICATIVE SPEED FOR SHAFT TOLERANCES:

SHAFT DIAMETER		SHAFT TOLERANCES				
		h6	h7	h8	h9	h11
Limiting speeds - Shaft tolerance						
mm	in.	RPM				
Ø12	-	9500	6000	4300	1500	950
Ø15	-	9500	6000	4300	1500	950
Ø16	-	9500	6000	4300	1500	950
Ø17	-	9500	6000	4300	1500	950
Ø20	-	8500	5300	3800	1300	850
Ø25	-	7000	4500	3200	1000	700
Ø30	-	6300	4000	2800	900	630
Ø35	-	5300	3400	2200	750	530
Ø40	-	4800	3000	1900	670	480
-	Ø1	7000	4500	3200	1000	700
-	Ø1 3/16	6300	4000	2800	900	630
-	Ø1 1/4	5600	3600	2500	800	550
-	Ø1 7/16	5300	3400	2200	750	530
-	Ø1 1/2	5000	3100	2000	700	500



MATERIALS AND CALCULATIONS - General index 7 3 5 1 0 a -

◀ back continue ▶

7 3 5 4 2 a Bearing selection

7 3 5 2 2 a Pressure of accumulation products

7 3 5 2 8 a 2500RR calculations

7 3 5 1 5 a Product handling

7 3 5 2 4 a 90° product transfer with belts

7 3 5 3 3 a 2253RTC calculations

7 3 5 1 9 a Product handling maximum acceleration

7 3 5 2 6 a Thermal expansion

7 3 5 7 8 a Coefficient of friction of standard materials



Chains & sprockets	Wear strips	Side guide brackets & accessories	Levelers	Engineering manual
Modular belts & sprockets	Chain & belt return systems	Frame & structure supports	Bearing supports	
Curves & tracks	Side guide solutions	Miscellaneous products	Equipment	



◀ back

MAXIMUM RADIAL LOAD CAPACITY OF HOUSING:

Values indicated in the table below, are obtained at 23°C. Value indicated: N, Values of polyamide version (values of polypropylene version in brackets), For further information please consult System Plast® SmartGuide® pages regarding bearing type you are interested in,

Series SQL ø mm				
12-15-16-17	6500	(-)	6000	(-)
20	5800	(-)	5300	(-)

Series UC FH/UC FH-R ø mm				
12-15-16-17	6500	(-)	7000	(-)
20	7000	(-)	7500	(-)
25	7500	(-)	8000	(-)
30	8000	(-)	8800	(-)
35	8500	(-)	9000	(-)

Bearing mounting. Go to:

7 3 0 5 2 a

Series UC FL/UC FL-W ø mm				
20	6900	(3200)	7500	(3500)
25	6750	(2950)	7200	(3000)
30	12000	(5800)	13000	(6000)
35	11000	(5300)	12800	(6000)
40	10800	(5100)	12850	(5800)

Series UC FQ/UC FQ-R ø mm				
12-15-16-17	12000	(-)	12000	(-)
20	12500	(-)	11500	(-)
25	12500	(-)	11500	(-)
30	12800	(-)	11000	(-)
35	12300	(-)	10500	(-)
40	12000	(-)	10000	(-)

Series UC PA/UC PA-R ø mm						
20	6500	(3000)	2000	(1000)	4000	(1600)
25	7800	(3200)	2500	(1400)	4800	(1800)
30	11000	(4000)	2900	(1500)	5700	(2000)

Series UC T/UC T-R ø mm						
20	7800	(3200)	2500	(1400)	4800	(1800)
25	6500	(3000)	2000	(1000)	4000	(1600)
30	12000	(5500)	3500	(1800)	6000	(2400)
35	10000	(3600)	2900	(1500)	5500	(2000)

Series UC FG/UC FG-R ø mm				
20	12000	(-)	10000	(-)
25	12500	(-)	11000	(-)
30	12800	(-)	11500	(-)

Series UC HE/UC HE-R ø mm						
20	10000	(3600)	2500	(1400)	4800	(1800)
25	8500	(3200)	2000	(1000)	4000	(1600)
30	14000	(6500)	3500	(1800)	6000	(2400)
35	12000	(5500)	2900	(1500)	5500	(2000)

Series UC FA/UC FA-R ø mm						
20	8000	(-)	2000	(-)	2500	(-)
25	8500	(-)	3000	(-)	3000	(-)
30	9000	(-)	3500	(-)	3500	(-)

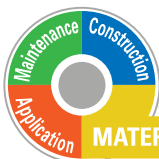

◀ back

7 3 5 4 2 a Bearing selection

7 3 5 2 2 a Pressure of accumulation products

7 3 5 2 8 a 2500RR calculations

7 3 5 1 5 a Product handling

7 3 5 2 4 a 90° product transfer with belts

7 3 5 3 3 a 2253RTC calculations

7 3 5 1 9 a Product handling maximum acceleration

7 3 5 2 6 a Thermal expansion

7 3 5 7 8 a Coefficient of friction of standard materials

Chains & sprockets	Wear strips	Side guide brackets & accessories	Levelers	Engineering manual
Modular belts & sprockets	Chain & belt return systems	Frame & structure supports	Bearing supports	
Curves & tracks	Side guide solutions	Miscellaneous products	Equipment	

7 3 5 6 0 a

STEEL CHAIN MATERIALS

MATERIALS



continue ►

Index chains.
Go to product page:

1 1 0 1 0 a

C45



CARBON STEEL: S AND SR

C45 steel material allows a higher yield load capability than stainless steel but is not corrosion resistant, thus only suitable for dry environments. Oil lubrication may be necessary to reduce rust and drag. The through hardened plate material provides a uniform hardness and a high abrasion resistance.

FEATURES:

- Surface hardness: 44 HRC

BENEFITS:

- High mechanical strength
- High abrasion resistance

STANDARD



STANDARD STAINLESS STEEL: SS AND SSL

AISI 430 Stainless steel material with good mechanical characteristics and corrosion resistance. An economical option for many conveying applications.

Lower load and lower wear resistance capability than our higher grade stainless steel materials.

FEATURES:

- Standard stainless steel

BENEFITS:

- Food grade
- Economical solution

EXTRA PLUS



EXTRA PLUS STAINLESS STEEL: SSE, SSSR, SSEL AND SPSP

High performance stainless steel, specially developed for high speed and heavy-duty application. Offers excellent corrosion resistance and surface hardness.

FEATURES:

- Surface hardness of HRC 26-30
- Extremely flat and smooth surface finish
- High corrosion and wear resistance
- Highest ultimate yield loading capability

BENEFITS:

- Food grade
- Typically used in glide liners and pressureless combiners and very long conveyors
- For improved product stability

AUSTENITIC



AUSTENITIC STAINLESS STEEL: SSA

AISI 304 Austenitic stainless steel which offers high corrosion and acid resistance properties.

FEATURES:

- Stainless steel with 18% chrome and 8% nickel

BENEFITS:

- Food grade
- High corrosion and acid resistance material

HIGH STRENGTH	FOOD GRADE	MEDIUM HIGH SPEED	VERY HIGH SPEED	CORROSION RESISTANCE	CHEMICAL RESISTANCE



MATERIALS AND CALCULATIONS - General index 7 3 5 1 0 a -

continue ►

7 3 5 7 3 a Nolu®-S parts

7 3 5 7 8 a Coefficient of friction of standard materials

7 3 5 8 6 a Chemical resistance of standard materials

7 3 5 7 6 a Storage of plastic chains and belts & RoHS

7 3 5 8 0 a Coefficient of friction - Measurement procedure

7 3 5 8 8 a Application temperatures

Chains & sprockets	Wear strips	Side guide brackets & accessories	Levelers	Engineering manual
Modular belts & sprockets	Chain & belt return systems	Frame & structure supports	Bearing supports	
Curves & tracks	Side guide solutions	Miscellaneous products	Equipment	



7 3 5 6 1 a PIN MATERIALS FOR STEEL AND PLASTIC CHAINS MATERIALS

◀ back continue ▶

SPM

STANDARD PIN MATERIAL

Special stainless steel with higher tensile strength and improved surface hardness. These pins are offered as standard in most stainless steel and plastic chains.



FEATURES:

- High wear, corrosion and acid resistance

BENEFITS:

- Longer wear life

HB

SPECIAL PIN MATERIAL

Vacuum hardened stainless steel with exceptionally high wear resistance characteristics, good corrosion and chemical resistance, for high speed and or abrasive applications with steel chain.



Pin wear is the main contributing factor in chain elongation.

Due to their extraordinary hardness, HB pins offer a much better resistance against mechanical/abrasive wear and thus extended service life of chain.

HB (Harten Bolzen) pins are recommended for the following operating conditions and applications:

- Abrasive environment (e.g. crate and bottle conveyors)
- Short conveyors running at high speed (e.g. filler area, inspector sections, pressure less combiners)
- High load applications (e.g. accumulation area, full crate conveyors, full bottle accumulation tables, keg lines)

FEATURES:

- Hardness > HRC 48

BENEFITS:

- Ultimate abrasion resistance
- Outstanding wear life
- Wear resistance twice of standard pin

SPECIAL PIN MATERIAL HB vs STANDARD PIN MATERIAL SPM

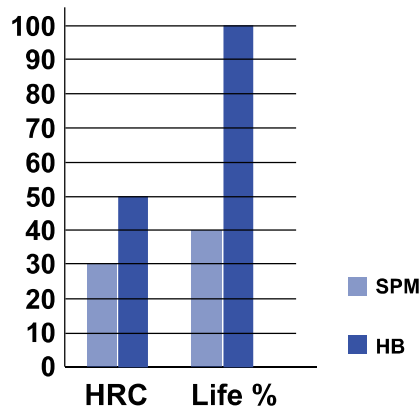

HIGH STRENGTH	VERY HIGH SPEED	CORROSION RESISTANCE	CHEMICAL RESISTANCE



MATERIALS AND CALCULATIONS - General index 7 3 5 1 0 a -

◀ back continue ▶

7 3 5 7 3 a Nolu®-S parts

7 3 5 7 8 a Coefficient of friction of standard materials

7 3 5 8 6 a Chemical resistance of standard materials

7 3 5 7 6 a Storage of plastic chains and belts & RoHs

7 3 5 8 0 a Coefficient of friction - Measurement procedure

7 3 5 8 8 a Application temperatures



Chains & sprockets	Wear strips	Side guide brackets & accessories	Levelers	Engineering manual
Modular belts & sprockets	Chain & belt return systems	Frame & structure supports	Bearing supports	
Curves & tracks	Side guide solutions	Miscellaneous products	Equipment	

7 3 5 6 2 a PIN MATERIALS FOR STEEL AND PLASTIC CHAINS MATERIALS

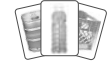

◀ back continue ▶

PPM



PLASTIC PIN MATERIAL

Special reinforced acetal resin. For plastic chains only.

FEATURES:

- Optimum strength

BENEFITS:

- Ultimate abrasion resistance
- Outstanding wear life
- Suitable for metal detection applications

FPM



FERRITIC STEEL PIN MATERIAL FOR MAGNETIC CHAINS

Ferritic Stainless-Steel pin is used for magnetic side-flexing chains. This material offers a great retention force in combination with magnetic curve.

FEATURES:

- High wear resistance

BENEFITS:

- Optimum retention force
- Longer wear life

SUITABLE FOR METAL DETECTION APPLICATION	MAGNETIC



MATERIALS AND CALCULATIONS - General index 7 3 5 1 0 a -

◀ back continue ▶

7 3 5 7 3 a Nolu®-S parts

7 3 5 7 8 a Coefficient of friction of standard materials

7 3 5 8 6 a Chemical resistance of standard materials

7 3 5 7 6 a Storage of plastic chains and belts & RoHS

7 3 5 8 0 a Coefficient of friction - Measurement procedure

7 3 5 8 8 a Application temperatures

Chains & sprockets	Wear strips	Side guide brackets & accessories	Levelers	Engineering manual
Modular belts & sprockets	Chain & belt return systems	Frame & structure supports	Bearing supports	
Curves & tracks	Side guide solutions	Miscellaneous products	Equipment	

7 3 5 6 3 a **PLASTIC CHAIN AND BELT MATERIALS**
MATERIALS



◀ back continue ▶

LF

LOW FRICTION ACETAL RESIN

This material is commonly used in the market and offers an improved coefficient of friction. It is also suitable for use in high speed applications.

LFG

Plastic Chain Color: Light Brown (LF), Dark Grey (LFG) or White (LFW)

LFB

Plastic Belt Color: Grey (LFG); Blue (LFB); white (LFW)

LFW

FEATURES:

- Optimum strength and wear life

BENEFITS:

- Food grade



Index chains.
Go to:

1 1 0 1 0 a

Index plastic belts.
Go to:

3 0 0 1 0 a

NG®evo

NG®evo conveyor components made from engineered plastic resin

Extra performance PBT with lowest coefficient of friction in our range, resulting in good strength and optimum wear resistance, reduced plate wear and reduced pitch elongation.

Available exclusively from Regal® System Plast® product.

Color: Grey Blue

FEATURES:

- Optimum strength and wear life
- Lowest coefficient of friction
- Optimum abrasive resistance
- Higher operating temperature in dry conditions

BENEFITS:

- Food grade
- High speed application
- Dry running application



HIGH STRENGTH	FOOD GRADE	MEDIUM HIGH SPEED	VERY HIGH SPEED	VERY LOW COEFFICIENT OF FRICTION



MATERIALS AND CALCULATIONS - General index **7 3 5 1 0 a** -

◀ back continue ▶

7 3 5 7 3 a Nolu®-S parts

7 3 5 7 8 a Coefficient of friction of standard materials

7 3 5 8 6 a Chemical resistance of standard materials

7 3 5 7 6 a Storage of plastic chains and belts & RoHS

7 3 5 8 0 a Coefficient of friction - Measurement procedure

7 3 5 8 8 a Application temperatures

Chains & sprockets	Wear strips	Side guide brackets & accessories	Levelers	Engineering manual
Modular belts & sprockets	Chain & belt return systems	Frame & structure supports	Bearing supports	
Curves & tracks	Side guide solutions	Miscellaneous products	Equipment	

7 3 5 6 5 a SPECIAL PLASTIC CHAIN AND BELT MATERIALS MATERIALS

On request and for adequate quantities belts may be produced in other materials such as:

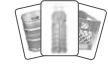

◀ back continue ▶

Index belts.
Go to:

3 0 0 1 0 a

AS



ANTI-STATIC ACETAL RESIN

Anti-static acetal material with improved surface conductivity for greater protection against static electrical discharges.

Color: Black (AS)

FEATURES:

- Antistatic

BENEFITS:

- Dissipates nuisance static build-up

HT



HIGH TEMPERATURE RESISTANT

Polyamide material based for high temperature applications up to 140°C.

Color: Natural white

BENEFITS:

- High temperature resistance
- Food grade

XT



EXTRA TEMPERATURE

This material with fiber glass-reinforced offers an excellent heat and chemical resistance for belt/chain and a good load capacity in respect to other materials. XT is suitable for extra high temperature applications up to 240° C.

Color: Beige

BENEFITS:

- Very high temperature up to 240°C

PP

PPW



CHEMICAL RESISTANCE

For belts: polypropylene material for greater chemical and temperature resistance. Polypropylene has lower mechanical strength than acetal. For belts (PP) the pins and clips are also made of Polypropylene.

Color: Beige (PP), White (PPW).

BENEFITS:

- Food grade
- Higher temperature resistance
- Optimum chemical resistance

PPG

PPLG



HIGH STABILIZED HOMOPOLYMER

For belts: Polypropylene material for a greater chemical and temperature resistance. This Polypropylene is a high stabilized homopolymer, combining high impact strength and stiffness. It has been developed especially for high detergent resistance and heat stability. Apart from pasteurizers, this material is also used in industrial washing machines, heat exchangers and dishwashers.

Color: Dark Grey (PPG), Light Grey (PPLG).

BENEFITS:

- Food grade
- Higher temperature resistance
- Optimum chemical resistance

CR



For chains: reinforced polypropylene material for greater acid and chemical resistance. Polypropylene has lower mechanical strength than acetal. **Reinforced PP is not food grade.**

Color: White (CR, for chains only)

Special colours

On request and for adequate quantities, chains and belts may be produced in other colours.

FOOD GRADE	ANTISTATIC	HIGH TEMPERATURE RESISTANCE	VERY HIGH TEMPERATURE RESISTANCE	CHEMICAL RESISTANCE



MATERIALS AND CALCULATIONS - General index 7 3 5 1 0 a -

◀ back continue ▶

7 3 5 7 3 a Nolu®-S parts

7 3 5 7 8 a Coefficient of friction of standard materials

7 3 5 8 6 a Chemical resistance of standard materials

7 3 5 7 6 a Storage of plastic chains and belts & RoHS

7 3 5 8 0 a Coefficient of friction - Measurement procedure

7 3 5 8 8 a Application temperatures



Chains & sprockets	Wear strips	Side guide brackets & accessories	Levelers	Engineering manual
Modular belts & sprockets	Chain & belt return systems	Frame & structure supports	Bearing supports	
Curves & tracks	Side guide solutions	Miscellaneous products	Equipment	

7 3 5 6 6 a SPECIAL PLASTIC CHAIN AND BELT MATERIALS

PP-FR-EC



FLAME RETARDANT, ELECTRICALLY CONDUCTIVE POLYPROPYLENE

Flammability according to UL94 is classified as V0. Due to the very low surface resistivity, this material can be considered electrically conductive.

Colour: Black.



◀ back continue ▶

Special colours

On request and for adequate quantities, chains and belts may be produced in other colours.

FLAME RETARDANT	ELECTRICALLY CONDUCTIVE



MATERIALS AND CALCULATIONS - General index 7 3 5 1 0 a -

◀ back continue ▶

7 3 5 7 3 a Nolu®-S parts

7 3 5 7 8 a Coefficient of friction of standard materials

7 3 5 8 6 a Chemical resistance of standard materials

7 3 5 7 6 a Storage of plastic chains and belts & RoHS

7 3 5 8 0 a Coefficient of friction - Measurement procedure

7 3 5 8 8 a Application temperatures

Chains & sprockets	Wear strips	Side guide brackets & accessories	Levelers	Engineering manual
Modular belts & sprockets	Chain & belt return systems	Frame & structure supports	Bearing supports	
Curves & tracks	Side guide solutions	Miscellaneous products	Equipment	

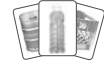

7 3 5 6 8 a **PIN MATERIALS FOR BELTS**
MATERIALS

◀ back continue ▶

Index belts.
Go to:

3 0 0 1 0 a

PBT

PBT

Most commonly used pin material in System Plast® belts. This material offers a high abrasion resistance as well as a low noise operation.

POM

POM

Polyacetal pins are used in System Plast® belts. This pin material gives optimum strength.

PP

PP

Polypropylene pins are used in all belts made of PP material. The pin material is adapted to the high temperature and high chemical resistance of the belt material.

SS

SS

Ferritic stainless steel pin is used for side-flexing belt 2120M. This material offers a great retention force in combination with magnetic curve.



MATERIALS AND CALCULATIONS - General index **7 3 5 1 0 a -**

◀ back continue ▶

7 3 5 7 3 a Nolu®-S parts

7 3 5 7 8 a Coefficient of friction of standard materials

7 3 5 8 6 a Chemical resistance of standard materials

7 3 5 7 6 a Storage of plastic chains and belts & RoHS

7 3 5 8 0 a Coefficient of friction - Measurement procedure

7 3 5 8 8 a Application temperatures

Chains & sprockets	Wear strips	Side guide brackets & accessories	Levelers	Engineering manual
Modular belts & sprockets	Chain & belt return systems	Frame & structure supports	Bearing supports	
Curves & tracks	Side guide solutions	Miscellaneous products	Equipment	



◀ back

7 3 5 7 0 a RUBBER MATERIALS MATERIALS

TPR

TPR (SEBS)

TPR is used for VG chains and belts and for plastic gripper chains. TPR is a SEBS type rubber, which assures an optimum bonding on the plastic base material.
Mechanical properties data available on MDS.

NBR

NBR

NBR rubber is used for our gripper chains serie 1874.
It offers a soft grip and a good resistance against oils.

EPDM

EPDM

EPDM rubber is used for our gripper chains.
It offers good weather and chemical resistance, although contact with oils, gasoline and concentrated acids must be avoided.

EPDM-PP

EPDM-PP

EPDM-PP rubber is used for our gripper chains.
It offers improved chemical resistance and can be used at higher temperatures.
Resistance against steam is good.



MATERIALS AND CALCULATIONS - General index 7 3 5 1 0 a -

◀ back

7 3 5 7 3 a Nolu®-S parts

7 3 5 7 8 a Coefficient of friction of standard materials

7 3 5 8 6 a Chemical resistance of standard materials

7 3 5 7 6 a Storage of plastic chains and belts & RoHS

7 3 5 8 0 a Coefficient of friction - Measurement procedure

7 3 5 8 8 a Application temperatures

Chains & sprockets	Wear strips	Side guide brackets & accessories	Levelers	Engineering manual
Modular belts & sprockets	Chain & belt return systems	Frame & structure supports	Bearing supports	
Curves & tracks	Side guide solutions	Miscellaneous products	Equipment	



continue ►

7 3 5 7 3 a

**NOLU®-S
MATERIALS**

WHAT ARE NOLU PLASTICS?

Nolu® plastic parts are made with Regal's exclusive compounds of UHMWPE and solid lubricants/unique ingredients. They provide reduced coefficients of friction while maintaining the characteristics of UHMWPE. Our featured component brands are Nolu-S, Nolu-SR and Nolu-SX.

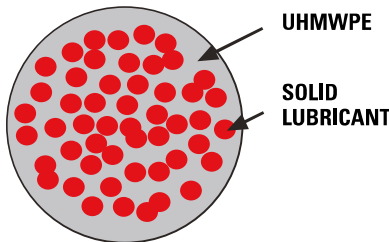

NOLU®-S

Nolu-S parts are made with a blend of UHMWPE and other dry lubricants that maintain good wear characteristics while significantly reducing coefficient of friction. Its unique self-lubricating properties make it ideal for applications requiring reduced friction and noise reduction.



FEATURES:

- RAM extruded or machined
- Very low coefficient of friction material flow
- High-impact strength
- Chemical resistant with minimal moisture absorption
- The Nolu®-S parts ingredients comply with EU and FDA food regulations
- Noise suppressant
- Easy to machine - most general power tools are sufficient

BENEFITS:

- Extends the life of mating surfaces
- Reduce surface marring and damage
- Reduces energy consumption
- Minimizes product pulsation on conveyors
- Low noise operation



MATERIALS AND CALCULATIONS - General index **7 3 5 1 0 a -**

continue ►

7 3 5 6 0 a Steel chain materials

7 3 5 7 8 a Coefficient of friction of standard materials

7 3 5 8 6 a Chemical resistance of standard materials

7 3 5 7 6 a Storage of plastic chains and belts & RoHs

7 3 5 8 0 a Coefficient of friction - Measurement procedure

7 3 5 8 8 a Application temperatures

Chains & sprockets	Wear strips	Side guide brackets & accessories	Levelers	Engineering manual
Modular belts & sprockets	Chain & belt return systems	Frame & structure supports	Bearing supports	
Curves & tracks	Side guide solutions	Miscellaneous products	Equipment	



◀ back

7 3 5 7 4 a NOLU®-S PARTS MATERIALS

NOLU®-SR PARTS

Nolu-SR parts have the same unique self-lubricating properties as Nolu®-S parts, however, they are made with additional proprietary ingredients. These unique ingredients increase the hardness of the material, providing superior wear resistance as compared to standard UHMWPE. Benefits of Nolu-SR parts include high wear resistance, extended wear life, minimization of product pulsation and low noise.

FEATURES:

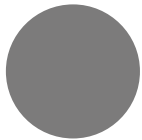

- RAM extruded or machined
- Superior wear resistance - greater than standard virgin or repro material
- Low coefficient of friction - promotes material flow
- High-impact strength
- The Nolu-SR parts are made with ingredients that comply with EU and FDA regulations
- Chemical resistant with minimal moisture absorption
- Easy to machine - most general power tools are sufficient

BENEFITS:

- Even greater wear resistance
- Extends the life of mating surfaces
- Reduce surface marring and damage
- Reduces conveyor chain loads
- Reduces energy consumption
- Reduces product pulsation on conveyors
- Low noise operation
- Suitable for running dry at higher speed

NOLU®-SX PARTS



Nolu-SX parts has the same unique self-lubricating properties as Nolu-SR parts; however, Nolu-SX parts has a material blend that reduces the thermal expansion characteristics of the material. The thermal expansion is reduced up to 40% compared to standard UHMWPE products, making it the ideal material for neck guides.

Nolu plastics should be stored at room temperature between 50°F (10°C) and 104°F (40°C) to prevent premature aging of the material. They should also be stored in a manner to prevent distortion. Regular cleaning is also recommended with warm water and soap agents with a pH value of 4.5 to 9.0. For more technical information regarding Nolu parts, please contact our Application Engineering Group.



MATERIALS AND CALCULATIONS - General index 7 3 5 1 0 a -

◀ back

7 3 5 6 0 a Steel chain materials

7 3 5 7 8 a Coefficient of friction of standard materials

7 3 5 8 6 a Chemical resistance of standard materials

7 3 5 7 6 a Storage of plastic chains and belts & RoHs

7 3 5 8 0 a Coefficient of friction - Measurement procedure

7 3 5 8 8 a Application temperatures



Chains & sprockets	Wear strips	Side guide brackets & accessories	Levelers	Engineering manual
Modular belts & sprockets	Chain & belt return systems	Frame & structure supports	Bearing supports	
Curves & tracks	Side guide solutions	Miscellaneous products	Equipment	



7 3 5 7 5 a CURVE, WEARSTRIPS, SIDE GUIDE, SPROCKETS AND RETURN ROLLER

MATERIALS

CURVES, WEARSTRIPS AND SIDE GUIDE MATERIALS

UHMWPE GREEN

ULTRA-HIGH MOLECULAR WEIGHT POLYETHYLENE (UHMWPE)

This Polyethylene polymer with extremely high molecular weight has several unique properties such as high abrasion resistance, impact strength and low coefficient of friction. The UHMWPE are used for our side guide profiles, curves and wearstrips.

UHMWPE BLACK

UHMWPE WHITE

UHMWPE WATER BLUE

UHMWPE-AS BLACK

ANTISTATIC ULTRA-HIGH MOLECULAR WEIGHT POLYETHYLENE (UHMWPE-AS)

This PE polymer with extremely high molecular weight has several unique properties such as good wear resistance, good impact strength, good sliding and antistatic properties. These properties make the material suitable for curves and straight tracks.

Surface Resistivity: $10^3 - 10^4 \Omega$; Volume Resistivity: $10^3 - 10^4 \Omega.cm$.

NOLU®-CP

NOLU®-CP PARTS

Nolu-CP parts are made with Regal's exclusive compounds of UHMWPE and micro glass beads. Curves and neck guide made with this material are the most suitable for abrasive working conditions.

POM - GREEN

POM-ACETAL

POM - WHITE

This polyacetal used for roller guide provide a high rigidity, hardness and toughness and good chemical resistance to alkalis.

SPROCKETS, IDLER MATERIALS

PA BLACK

GLASS FIBER REINFORCED POLYAMIDE (PA-FV)

The reinforced polyamide with glass fiber is used for molded sprockets and idlers to offer a high strength and wear resistance.

PA WHITE

POLYAMIDE (PA)

The cast polyamide 6 is used for machined sprockets and idlers to offer a high strength and wear resistance.

RETURN ROLLERS MATERIALS

PE-HD BLACK

HIGH-DENSITY POLYETHYLENE (PE-HD)

PE-HD GREEN

The high-density polyethylene is used for return roller and it has a good abrasion resistance, impact strength and a low coefficient of friction.

PA BLACK

POLYAMIDE (PA)

PA GREEN

The impact polyamide resin is used for return roller to offer a high strength and wear resistance.



MATERIALS AND CALCULATIONS - General index 7 3 5 1 0 a -

7 3 5 6 0 a Steel chain materials

7 3 5 7 8 a Coefficient of friction of standard materials

7 3 5 8 6 a Chemical resistance of standard materials

7 3 5 7 6 a Storage of plastic chains and belts & RoHs

7 3 5 8 0 a Coefficient of friction - Measurement procedure

7 3 5 8 8 a Application temperatures



Chains & sprockets	Wear strips	Side guide brackets & accessories	Levelers	Engineering manual
Modular belts & sprockets	Chain & belt return systems	Frame & structure supports	Bearing supports	
Curves & tracks	Side guide solutions	Miscellaneous products	Equipment	



continue ►

7 3 5 7 6 a STORAGE OF PLASTIC CHAINS AND BELTS AND RoHS MATERIALS

STORAGE OF PLASTIC CHAINS AND BELTS

Plastic chains, belts and components offer best stability and resistance against environmental effects at appropriate storage:

- In the original packaging, and not exposed to the environment
- Without environmental radiation / UV light / direct sunlight
- Dry
- In a non-aggressive environment
- A consistent temperature between 10°C (50° F) and 40°C (104° F)

FIRST IN, FIRST OUT

- We have applied that procedure in our logistic department.
- We recommend this procedure to any external warehouse.

Do not stack pallets or other heavy goods on top of chain packs. Chains inside the packs might get damaged. Do not stack chain packs higher than the original stacking height - as dispatched from our shipping department.

PRODUCT SHELF LIFE

PRODUCT CLASS	TIME FROM MANUFACTURING DATA	REFURBISH (INSPECT, CLEAN, RELUBRICATE AND REPACKAGE)	DON'T USE
All solid steel and cast iron	5 years	5 years	10 years
Plastic: rubber and EPDM	3 years	Not Applicable	3 years
Plastic: UHMWPE	3 years	Not Applicable	3 years
Plastic belts and Chains	3 years	Not Applicable	3 years
Plastic idler and sprockets	3 years	Not Applicable	3 years
Bearings	3 years	3 years	6 years

RoHS

System Plast® CHAINS, BELTS AND COMPONENTS materials do meet the base requirements of this european directive. Therefore, the RoHS (Restriction of Hazardous Substances) directive of 2002/95/CE and subsequent modifications do not apply to our products.

ATEX

FOR ATEX APPLICATION, CONTACT OUR TECHNICAL SUPPORT.

REACH

Regal materials meet the requirements of this European regulation.



MATERIALS AND CALCULATIONS - General index 7 3 5 1 0 a -

continue ►

7 3 5 6 0 a Steel chain materials

7 3 5 7 8 a Coefficient of friction of standard materials

7 3 5 8 6 a Chemical resistance of standard materials

7 3 5 7 3 a Nolu®-S parts

7 3 5 8 0 a Coefficient of friction - Measurement procedure

7 3 5 8 8 a Application temperatures

Chains & sprockets	Wear strips	Side guide brackets & accessories	Levelers	Engineering manual
Modular belts & sprockets	Chain & belt return systems	Frame & structure supports	Bearing supports	
Curves & tracks	Side guide solutions	Miscellaneous products	Equipment	

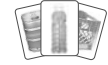

◀ back

7 3 5 7 7 a DISPOSAL OF PRODUCTS

DISPOSAL OF PLASTIC CHAINS AND BELTS

The non-electric nor electronics waste (plastic, rubber and metals parts) are not considered special waste and must be disposed of in strict compliance with the local regulations regarding non-special waste.

DISPOSAL OF MODSORT® MODULES

The wood packaging material of Modsor[®] modules is fully recyclable and FITOK certified in accordance with the ISPM-15 regulation.



The electrical and electronic parts of Modsor[®] modules listed below are marked with the symbol



and classified as Waste of electric and electronic equipment (WEEE) in accordance with the European Directive 2012/19 / EU on WEEE.

- Control Card
- Divert Belt and Roller Top Belt's Motorized Drive Rollers (MDRs)
- Photo eyes
- Power Supply Unit

These WEEE must be disposed correctly at a suitable collection point according to the procedures in use in the country of disposal.

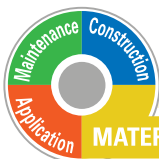

MATERIALS AND CALCULATIONS - General index 7 3 5 1 0 a -

◀ back

7 3 5 6 0 a Steel chain materials

7 3 5 7 8 a Coefficient of friction of standard materials

7 3 5 8 6 a Chemical resistance of standard materials

7 3 5 7 3 a Nolu®-S parts

7 3 5 8 0 a Coefficient of friction - Measurement procedure

7 3 5 8 8 a Application temperatures

Chains & sprockets	Wear strips	Side guide brackets & accessories	Levelers	Engineering manual
Modular belts & sprockets	Chain & belt return systems	Frame & structure supports	Bearing supports	
Curves & tracks	Side guide solutions	Miscellaneous products	Equipment	



7 3 5 7 8 a COEFFICIENTS OF FRICTION OF STANDARD MATERIALS

MATERIALS

Below listed coefficients can be used as a guideline. Depending on environmental and application requirements, (temperatures, lubricant, material combinations, dirt/debris, product and chain/belt surfaces, etc.) the coefficients are subject to some variation. Values are generally conservative.

COEFFICIENT OF FRICTION BETWEEN CHAIN/BELT AND WEARSTRIP:

CHAIN/BELT MATERIAL	LUBRICATION	WEAR STRIP MATERIAL					
		STAINLESS STEEL	UHMWPE PA	NOLU [®] -S PARTS	WOOD	RETURN ROLLER	EXTRA WITH METAL STRIP
Stainless steel	Dry	N/A	0.35	0.32	0.35	0.10	not applicable
	Dry lube	0.39	0.26	0.23	N/A	0.08	
	Water&Soap	0.20	0.18	0.15	N/A	0.05	
Carbon steel	Dry lube or Oil lube	0.39	0.26	0.23	N/A	0.08	not applicable
LF - Acetal	Dry	0.24	0.20	0.18	0.23	0.10	0.19
	Dry lube	0.18	0.17	0.13	N/A	0.07	0.14
	Water&Soap	0.15	0.10	0.10	N/A	0.05	0.10
NG [®] evo conveyor components made from engineered plastic resin	Dry	0.20	0.16	0.13	0.17	0.10	0.14
	Dry lube	0.16	0.10	0.08	N/A	0.07	0.09
	Water&Soap	0.14	0.09	0.08	N/A	0.05	0.09
PP / CR	Dry	0.29	0.24	0.21	0.22	0.10	0.23
	Dry lube	0.22	0.18	0.16	N/A	0.07	0.17

Valid for ambient temperature 21°C (70° F)

COEFFICIENT OF FRICTION BETWEEN CHAIN/BELT AND PRODUCT:

CHAIN/BELT MATERIAL	LUBRICATION	PRODUCT MATERIAL					
		PAPER CARTON	METAL (STEEL)	ALUMINUM	PLASTICS INCL. PET	GLASS (RETURN)	NEW GLASS, CERAMICS
Stainless steel	Dry	0.40	0.50	0.35	0.30	0.47	0.35
	Dry lube	N/A	0.34	0.29	0.24	0.30	0.29
	Water&Soap	N/A	0.20	0.15	0.15	0.21	0.15
Carbon steel	Dry lube or Oil lube	N/A	0.34	0.29	0.24	0.30	0.29
Speed - Line	Dry	0.40	0.45	0.32	0.27	0.40	0.29
	Dry lube	N/A	0.29	0.26	0.22	0.25	0.23
	Water&Soap	N/A	0.15	0.14	0.13	0.18	0.13
LF - Acetal	Dry	0.28	0.25	0.25	0.21	0.24	0.20
	Dry lube	N/A	0.19	0.17	0.15	0.17	0.14
	Water&Soap	N/A	0.15	0.14	0.13	0.14	0.12
NG [®] evo conveyor components made from engineered plastic resin	Dry	0.20	0.18	0.15	0.13	0.14	0.12
	Dry lube	N/A	0.15	0.13	0.11	0.12	0.11
	Water&Soap	N/A	0.13	0.12	0.10	0.11	0.10
LBP	Dry	0.10	0.10	0.10	0.10	0.10	0.10
VG	Dry	0.60	0.73	0.50	0.50	0.50	0.50
PP / CR	Dry	0.40	0.30	0.32	0.28	0.29	0.26
	Dry lube	N/A	0.23	0.25	0.21	0.22	0.20

Valid for ambient temperature 21°C (70° F)

For iCOF[®] device. Go to product page:

5 7 0 8 0 a



MATERIALS AND CALCULATIONS - General index 7 3 5 1 0 a -

7 3 5 8 0 a Coefficient of friction - Measurement procedure

7 3 5 7 3 a Nolu[®]-S parts

7 3 5 8 6 a Chemical resistance of standard materials

7 3 5 6 0 a Steel chain materials

7 3 5 7 6 a Storage of plastic chains and belts & RoHs

7 3 5 8 8 a Application temperatures



Chains & sprockets	Wear strips	Side guide brackets & accessories	Levelers	Engineering manual
Modular belts & sprockets	Chain & belt return systems	Frame & structure supports	Bearing supports	
Curves & tracks	Side guide solutions	Miscellaneous products	Equipment	



7 3 5 8 0 a **COEFFICIENT OF FRICTION - MEASUREMENT PROCEDURE**

MATERIALS

In this section, we will describe the measurement method for coefficient of friction (COF or μ) between belt/chain and product on a running conveyor.

The COF is defined as the ratio between the force necessary to move one surface horizontally over another and the pressure between the two surfaces. It can be measured by dividing the force required to push or pull an object by its weight. The pull and the product weight can be determined by measurement using a spring or force gauge. Please follow the below instructions, ensuring both conveyor and sample product are clean and clear of all debris:

1- At first be sure to have:

- a. Mechanical or digital spring gauge with suitable sensitivity and accuracy
- b. A spirit level gauge (in case of inclined conveyor)
- c. A suitable sample of product weight (bottles/cans etc.)
- d. Available space on the running conveyor where the COF measurement is required

2- Measure the sample weight (W):

- a. Use sample product with suitable weight. It is recommended to collect one or more products to get 1 kg of product weight.
- b. Measure the product weight using a scale or spring gauge
- c. Record the value when the scale is stabilized

3- Measure the pull (F₀):

- a. Be sure that conveyor is running and the surface is level. Otherwise measure carefully the angle
- b. With the same sample as step 2.a), take measurements in the same location on the conveyor and at the same speed if possible
- c. Secure the gauge to a fixed point on the conveyor or hold the gauge by hand avoiding movements. If possible, steady your hand by resting it on conveyor frame or guide rail
- d. Ensure that the gauge is parallel to the conveyor
- e. Put the sample product on the conveyor, attach to spring gauge, and measure the horizontal pull (F₀).
- f. Take the value when the measurement is stabilized
- g. Make three (03) measurements at the same conditions
- h. Make the average of the obtained three (03) values
- i. Repeat steps 2 and 3 for multiple different containers

4- COF calculation:

- a. Be sure that the average W and F₀ values are in the same measurement unit (g or kg or lb);
- b. Use the formula $\mu = \frac{F_0}{W} = \frac{\text{measured pull}}{\text{measured weight}}$ to obtain the average value of COF; (4b)

Be aware that for some gauges it is required to compensate the reading with the plunger weight (P) (1) since it is used horizontally. Refer to page **7 3 5 8 1 a** for further details.

With the plunger weight compensation, the formula 4b) becomes:

$$\mu = \frac{(F_0 + P)}{W} = \frac{\text{measured pull} + \text{plunger weight}}{\text{measured weight}}$$

If the conveyor is inclined with respect to the running direction, the angle α is to be considered as following:

- Measure the angle α (usually from 2° to 5°);
- Use the formula $\mu = \frac{(F_0 + P)}{W \cos \alpha} - \tan \alpha$ (Running direction downwards) (1).
- Use the formula $\mu = \frac{(F_0 + P)}{W \cos \alpha} + \tan \alpha$ (Running direction upwards) (1).

Notes: (1) P=0 for spring gauges with adjustable preload. Refer to good measurement practice for further details.



MATERIALS AND CALCULATIONS - General index 7 3 5 1 0 a -

7 3 5 7 8 a Coefficient of friction of standard materials

7 3 5 7 3 a Nolu®-S parts

7 3 5 8 6 a Chemical resistance of standard materials

7 3 5 6 0 a Steel chain materials

7 3 5 7 6 a Storage of plastic chains and belts & RoHs

7 3 5 8 8 a Application temperatures



Chains & sprockets	Wear strips	Side guide brackets & accessories	Levelers	Engineering manual
Modular belts & sprockets	Chain & belt return systems	Frame & structure supports	Bearing supports	
Curves & tracks	Side guide solutions	Miscellaneous products	Equipment	



continue ►

7 3 5 8 1 a COEFFICIENT OF FRICTION - GOOD MEASUREMENT PRACTICE

MATERIALS

Here we describe good practices when measuring the COF within belt/chain in a running conveyor.

SELECTION OF THE INSTRUMENT

The higher the sensibility, the more accurate the measurement. 10 g divisions and +/- 10% (or ounces) is a good compromise for a rough estimation.

A. Gauge with mechanical spring (0-10 kg)

- i. Needs certain weight
- ii. Needs to compensate spring preload and "plunger"
- iii. Is more accurate / repeatable

There are spring gauges on the market with adjustable preload, in order to compensate the plunger. For those types of gauges, just adjust the reading scale to 0 when reading in horizontal position. Remember to reset the scale to 0 when reading values in vertical position (i.e. when weighting a bottle).

B. Digital gauge (0-45 kg)

- i. Needs lower weight
- ii. Don't always need to compensate for the "plunger"
- iii. Less accurate / repeatable

REQUIRED ACTIVITIES AND CHECKS PRIOR TO MEASUREMENT

A. Gauge with mechanical spring: Plunger preload determination

- i. Prior to the measurement ensure that also the spring dynamometer reads zero when in vertical working position. Tare if necessary.
- ii. Weight the dynamometer on a balance or using a second scale. Record the value. Weight reading of the total scale $x = A$ plunger preload + B scale body [g]
- iii. Hang the dynamometer upside down. If the instrument's own weight is not enough to pull the plunger by at least 10% of his own full scale, hang some additional weight at the bottom. The additional weight should be deducted from the reading.
- iv. Weight reading of the scale upside-down $y = B$ scale body - A plunger [g]. Read and store the value on the scale.

v. Plunger weight (spring preload) will be $A = \frac{x - y}{2}$ RECORD THIS VALUE!

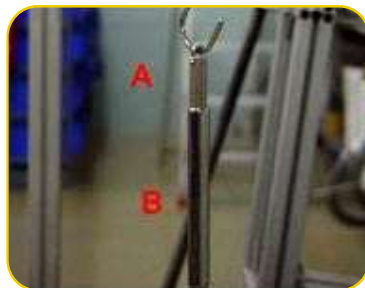

Example:

Gauge weights 140 g, upside-down reading is 36 g, the spring-preload is $(140-36)/2 = 52$ g. For the horizontal reading, you will have to add this value to the displayed forc.



MATERIALS AND CALCULATIONS - General index 7 3 5 1 0 a -

continue ►

7 3 5 7 8 a Coefficient of friction of standard materials

7 3 5 7 3 a Nolu®-S parts

7 3 5 8 6 a Chemical resistance of standard materials

7 3 5 6 0 a Steel chain materials

7 3 5 7 6 a Storage of plastic chains and belts & RoHS

7 3 5 8 8 a Application temperatures



Chains & sprockets	Wear strips	Side guide brackets & accessories	Levelers	Engineering manual
Modular belts & sprockets	Chain & belt return systems	Frame & structure supports	Bearing supports	
Curves & tracks	Side guide solutions	Miscellaneous products	Equipment	

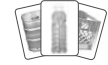

◀ back

7 3 5 8 2 a COEFFICIENT OF FRICTION - GOOD MEASUREMENT PRACTICE

MATERIALS

B. Digital gauge: Plunger preload determination

If your digital tool offers the possibility to switch it to horizontal, you don't need to calculate the plunger preload. In fact, in horizontal configuration, the cell automatically pre-sets to zero.

Some digital tools, on the contrary, do not allow to be switched to horizontal (they need a certain weight, given by the plunger when lying vertically to activate the cell). Under such condition proceed in plunger preload determination as per previous point.

Periodically check your instrument and compare the measurements with a second one. This is required to check any possible deviation of measurements due to loss of tare.

Recommendations

- A higher is the sample product weight, a lower is the error in the estimated value
 - If possible, we recommend using multiple containers to increase product weight
- Measure the product weight close to the ground so as to prevent any dropped bottles from breaking
- Take a stabilized measurement. Instrument gauge has a response time, so we recommend respecting this time to read an accurate value
- The more measurements that are taken and averaged, the more reliable the result will be.
- A smooth, clean surface allows an accurate COF measurement without the influence of wear
- Using the same sample(s) in all measurements will lead to a uniform and repeatable value
- Securing the gauge to a fixed point on the conveyor will remove human error from holding the spring gauge
- Ensure you hold the gauge and the plunger parallel to the conveyor, so as to achieve an accurate measurement



MATERIALS AND CALCULATIONS - General index 7 3 5 1 0 a -

◀ back

7 3 5 7 8 a Coefficient of friction of standard materials

7 3 5 7 3 a Nolu®-S parts

7 3 5 8 6 a Chemical resistance of standard materials

7 3 5 6 0 a Steel chain materials

7 3 5 7 6 a Storage of plastic chains and belts & RoHs

7 3 5 8 8 a Application temperatures

Chains & sprockets	Wear strips	Side guide brackets & accessories	Levelers	Engineering manual
Modular belts & sprockets	Chain & belt return systems	Frame & structure supports	Bearing supports	
Curves & tracks	Side guide solutions	Miscellaneous products	Equipment	

7 3 5 8 6 a CHEMICAL RESISTANCE OF STANDARD MATERIALS

MATERIALS

Data shown in the table was taken from laboratory tests performed on unstrained samples and are merely indicative.

Chemical resistance under normal working conditions can depend on various factors, such as stress and temperature, concentration of the chemical agent and contact time. Conveyor rinsing can also be a huge factor, as a corrosive chemical that is allowed to dry and concentrate will be more problematic than one that is allowed contact for a short time and thoroughly rinsed away.



continue ►

VALID FOR AMBIENT TEMPERATURE (21°C / 70°F)

CHEMICAL AGENT	METALS								PLASTICS						RUBBERS												
	EXTRA		AISI 304		AISI 316		OT.NI		LF (POM)		NGE (PBT)		PP		PA		PE		EPDM		NBR		SEBS		VITON*		
	C%		C%		C%		C%		C%		C%		C%		C%		C%		C%		C%		C%		C%		
Acetic Acid	5	✓	20	✓	100	✓		○	5	✗	10	✓	40	✓	10	✗	10	✓	25	✓		✗	25	○	20	✗	
Acetone		✓	25	✓		✓	✓			○		○		✓	100	✓		✓		✓		✗		○		✗	
Acrylonitrile						✓									100	✓		✓		✓		✗		○		✗	
Aluminium chloride				○	10	○								○	10	✓		✓		✓		✓	✓	✓	SA	✓	
Aluminium sulphate					SA	✓								✓	10	✓	SA	✓		✓		✓	✓	✓	SA	✓	
Amyl alcohol				✓		✓					✓		✓	10	✓				✓					✓		✓	
Ammonia		✓	100	✓		✓		✗		✓		○	30	✓	10	✓		✓		○		○	○	○		○	
Ammonium chloride				○		✓						10	✓	10	✓		✓		✓		✓	✓	✓	SA		✓	
Aniline		✓			✓	✓							✓	100	○	3	✓		✗		✗	✗	✗			✓	
Barium chloride				○	SA	✓							✓	10	✓		✓		✓		✓	✓	✓	✓		✓	
Beer		✓		✓		✓		✓		✓			✓				✓		✓		✓	✓	✓	✓		✓	
Benzene		✓	70	○		✓			✓		✓		✓				○		✗				✗			✓	
Benzoic acid			100	✓	SA						✓	SA	SA	○				✗		✓		✓	✗		✓		
Benzol				✓		✓		✓		✓			○	100	✓		✓		✗		✗	✗	✗			○	
Boric acid		○	SA	✓		✓			✗	10	✓	SA	✓	10	✓	SA	✓		✓		✓	✓	✓	SA		✓	
Brine	10	✗		○		✓							○		○		✓		✓				○			○	
Butter				✓		✓		✓		✓			✓				✓		✓		✓	✓	○			✓	
Butyl acetate						✓			✓		○	○	100	✓				○					○			✗	
Butyl alcohol				✓					✓		✓		100	✓			✓		✓		○		✓			✓	
Butyl glycole						✓					✓		100	✓			✓		✓				✓			✓	
Calcium chloride		✗		○		✓		✓	10	✓		✓	50	✓	10	✓	SA	✓		✓			✓	SA		✓	
Carbon sulphide				✓		✓				✓			✓	100	✓		○		✗		✗	✗	✗			✓	
Carbon tetrachloride			10	✓				✓		✓			✗		✓				✗		✗					✓	
Chlorine water		✗		✗		○			✗	✗		✗					✓		3	○			3	○			
Chloroform		○	10	✓		✓		✓		✗	✗		○	100	✗		✗		✗		✗	✗	✗			✓	
Chromic acid			25	✓	50	○			✗	○				1	○	50	○		50	○	✗	50	✗	50	✗	50	✓
Citric acid	10	✓		✓	SA			✗		○	10	✓	10	✓	10	○	SA	✓		✓		✓	✓	SA		✓	
Cyclohexane						✓						✓		100	✓		✓		✗		✓		✗			✓	
Cyclohexanol						✓						✓		100	✓		✓		✗		✓		○			✓	
Decalin						✓						○		✓				✗		○		○	✗			✗	
Dioxane						✓			○		✓		○		✓		✓		○		○	✗	✗			✗	
Distilled water		✓	10	✓		✓		✓		✓		✓		✓		✓		✓		✓		✓	✓			✗	
Ethyl acetate				○		✓			○		○		✓	100	✓		✓			✗						○	
Ethyl alcohol				✓						✓		96	✓	96	✓	96	✓		○		○					✓	
Ethyl chloride				✓				○		✓		✗		100	✓		○		○		○					✗	
Ethyl ether						✓						✓		100	✓		○									✓	
Ferric chloride				○		✓			○	10	✓		✓	10	✓		✓		✓		✓		✓	SA		✓	
Food fats		✓	100	✓		✓				✓				✓		✓		○		○		○				✓	
Food oils		✓		✓		✓				✓				✓		✓		○		○		○				✓	

* Viton is believed to be the trademark and/or trade name of The Chemours Company FC, LLC and is not owned or controlled by Regal Beloit Corporation.

ABBREVIATION

- ✓ = good resistance
- = fairly good resistance depending on use conditions
- ✗ = insufficient resistance (not recommended)
- C = concentration
- SA = saturated
- blank spaces = no tests performed

All values are only applicable to temperatures below 21°C / 70°F.



MATERIALS AND CALCULATIONS - General index 7 3 5 1 0 a -

continue ►

7 3 5 6 0 a Steel chain materials

7 3 5 7 6 a Storage of plastic chains and belts & RoHs

7 3 5 8 0 a Coefficient of friction - Measurement procedure

7 3 5 7 3 a Nolu®-S parts

7 3 5 7 8 a Coefficient of friction of standard materials

7 3 5 8 8 a Application temperatures



Chains & sprockets	Wear strips	Side guide brackets & accessories	Levelers	Engineering manual
Modular belts & sprockets	Chain & belt return systems	Frame & structure supports	Bearing supports	
Curves & tracks	Side guide solutions	Miscellaneous products	Equipment	

7 3 5 8 6 b CHEMICAL RESISTANCE OF STANDARD MATERIALS MATERIALS

Data shown in the table was taken from laboratory tests performed on unstrained samples and are merely indicative.



Chemical resistance under normal working conditions can depend on various factors, such as stress and temperature, concentration of the chemical agent and contact time. Conveyor rinsing can also be a huge factor, as a corrosive chemical that is allowed to dry and concentrate will be more problematic than one that is allowed contact for a short time and thoroughly rinsed away.

◀ back continue ▶

VALID FOR AMBIENT TEMPERATURE (21°C / 70°F)

CHEMICAL AGENT	METALS				PLASTICS					RUBBERS											
	EXTRA	AISI 304	AISI 316	OT.NI	LF (POM)	NGE (PBT)	PP	PA	PE	EPDM	NBR	SEBS	VITON*								
	C%	C%	C%	C%	C%	C%	C%	C%	C%	C%	C%	C%	C%								
Formaldehyde		✓	✓	✓	✓	✓	40	✓	30	✓	○	○	○	40	✗						
Formic acid	2	○	✗	100	✓	✓	10	✗	○	10	✗	85	✓	✓	○						
Freon 12			✓						✓	100	○		✓		✓						
Fresh water		✓	✓	✓		✓	✓	✓	✓	✓	✓	✓	✓	✓	✓						
Fruit juice		✓	○	✓		✓	✓	✓	✓	✓	✓	✓	✓	✓	✓						
Gasoline		✓	✓	✓	○	✓	○	○	✓	○	✗	○	✗	✗	✓						
Glycerine		✓	✓	✓	○	✓	✓	✓	✓	✓	✓	✓	✓	✓	✓						
Hydrochloric acid		✗	✗	✗	○	35	✗	20	○	30	✓	✗	35	✓	15	✓	15	✓	37	✓	
Hydrofluoric acid			✗	✗				5	○	40	✓	✗	70	✓		✗			48	✓	
Hydrogen peroxide	3	✓	✓	100	✓		30	✓	5	✓		✗	10	○	30	○	✗	30	✗	90	✓
Isopropyl alcohol				✓		✓	✓	✓	✓	✓	✓	✓	✓	✓	✓	✓	✓	✓	✓	✓	✓
Lactic acid		○		✓	✗	✓	10	✓	20	✓	✓	✓	✓	○	✓	○	✓	○	✓	✓	✓
Linseed oil			✓	✓		✓	✓	✓	✓	✓	✓	✓	✓	○	✓	○	✓	✗			✓
Magnesium chloride			○	✓				✓	✓	✓	✓	✓	✓	✓	✓	✓	✓	✓	SA		✓
Methyl acetate			○	✓			○	○	✓	✓	✓	✓	✓	○	✗	✗	✗	✗	✗		✗
Methyl alcohol			80	✓	✓	✓	✓	✓	✓	✓	✓	✓	✓	✓	○	○	✓	○	✓		○
Methylene chloride		○	○	✓	✓	✓	✗	✗	○	○	○	○	○	✗	✗	✗	✗	✗	○		○
Milk		✓	✓	✓	✓	✓	✓	✓	✓	✓	✓	✓	✓	○	○	✓	✓	✓	✓	✓	✓
Mineral oil			✓	✓		✓	✓	✓	✓	✓	✓	✓	✓	✗	✓	✓	✗	✓	✗		✓
Nitric acid	25	○	65	✓			✗		✓	✓	✗	○			10	✗			70	✓	
Nitrobenzene				✓		✓	✓	✓	○	✓	✓	✓	✗	✗	○	○	○	○	○		○
Oxalic acid			65	✓	✓			10	✓	✓	○	○	✓	○	○	○	○	○	○		✓
Paraffin				✓		✓	✓	✓	✓	✓	✓	✓	✓	○	○	○	✗				✓
Petroleum			✓	✓	✓	✓	✓	✓	✓	✓	✓	✗	✗	✗	✓	✓	✗	✗	✗		✓
Petroleum ether			✓	✓	✓	✓	○	○	✓	✓	✓	✓	✓	✗	✗	✗	✗	✗	✗		✓
Phenol			✓	✓	✓	○	○	✗	✓	✓	✓	✓	○	○	○	○	○	○	○		✓
Phosphoric acid	25	○	✗	✓	✓	✗	✗	✗	✓	✓	✓	✓	✓	✓	20	○	○	✓	85	✓	✓
Potassium bichromate				SA	✓			○	✓	○	SA	✓	✓	✓	○	○	○	SA			✓
Potassium bromite				✓				✓	✓	✓	10	✓	✓	✓	✓	✓	✓	✓	✓		✓
Potassium hydroxide		✓	50	✓	✓		✓	✗	✓	✓	✓	✓	✓	✓	○	○	✓	✓	✓		✓
Potassium permanganate			✓	✓	✓	10	○	○	✓	✓	✗	✓	10	✓	✓	✗	10	○	○		✓
Sea water		✗	✓	✓	✓	○	○	✓	✓	✓	✓	✓	✓	✓	✓	✓	✓	○	○		✓
Silicone oil				✓				✓	✓	✓	✓	✓	✓	✓	✓	✓	✓	✓	✓		✓
Silver nitrate			○	✓					✓	✓	✓	✓	✓	○	○	○	○	○			✓
Sodium carbonate		✓	100	○	SA	✓	10	✓	10	✓	✓	✓	✓	✓	✓	✓	✓	✓	✓		✓
Sodium chloride		○	○	✓	✓		✓	10	✓	✓	✓	✓	✓	✓	✓	✓	✓	✓	✓	SA	✓
Sodium hydroxide	40	✓	✓	60	✓		✓	10	✗		✓	✓	✓	✓	○	○	✓	✓	✓		✓
Sodium hypochlorite			✗	SA	○		✗	10	✓	✓	✓	✓	10	✓	✓	✗	10	○	5		✓
Sodium silicate			100	✓	✓					✓	✓	✓	✓	✓	✓	✓	✓	✓	✓		✓

* Viton is believed to be the trademark and/or trade name of The Chemours Company FC, LLC and is not owned or controlled by Regal Beloit Corporation.

ABBREVIATION

- ✓ = good resistance
- = fairly good resistance depending on use conditions
- ✗ = insufficient resistance (not recommended)
- C = concentration
- SA = saturated
- blank spaces = no tests performed

All values are only applicable to temperatures below 21°C / 70°F.

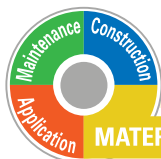

MATERIALS AND CALCULATIONS - General index 7 3 5 1 0 a -

◀ back continue ▶

7 3 5 6 0 a Steel chain materials

7 3 5 7 6 a Storage of plastic chains and belts & RoHs

7 3 5 8 0 a Coefficient of friction - Measurement procedure

7 3 5 7 3 a Nolu®-S parts

7 3 5 7 8 a Coefficient of friction of standard materials

7 3 5 8 8 a Application temperatures



Chains & sprockets	Wear strips	Side guide brackets & accessories	Levelers	Engineering manual
Modular belts & sprockets	Chain & belt return systems	Frame & structure supports	Bearing supports	
Curves & tracks	Side guide solutions	Miscellaneous products	Equipment	

7 3 5 8 6 c CHEMICAL RESISTANCE OF STANDARD MATERIALS MATERIALS

Data shown in the table was taken from laboratory tests performed on unstrained samples and are merely indicative.



Chemical resistance under normal working conditions can depend on various factors, such as stress and temperature, concentration of the chemical agent and contact time. Conveyor rinsing can also be a huge factor, as a corrosive chemical that is allowed to dry and concentrate will be more problematic than one that is allowed contact for a short time and thoroughly rinsed away.

◀ back

VALID FOR AMBIENT TEMPERATURE (21°C / 70°F)

CHEMICAL AGENT	METALS				PLASTICS					RUBBERS			
	EXTRA	AISI 304	AISI 316	OT.NI	LF (POM)	NGE (PBT)	PP	PA	PE	EPDM	NBR	SEBS	VITON*
	C%	C%	C%	C%	C%	C%	C%	C%	C%	C%	C%	C%	C%
Sodium sulphate		100 ✓	✓	✓				✓	SA ✓	○	✓	✓	✓
Soft drinks		✓	✓	✓	✓	✓	✓	✓	✓	✓	✓	✓	✓
Suds		✓	✓	✓		10 ✓	✓	✓	✓	✓	✓	✓	✓
Sulphuric acid	✗	✗	○	✓	✗	2 ✓	✓	✓	✗	80 ✓	50 ✓	✗	50 ○
Tartaric acid	✓	50 ✓	✓	✗	○	50 ✓	✓	✓	✓	✓	○	✓	✓
Tetrahydrofuran			✓		○	✓	○	✓	○	✗	✗	✗	✗
Tetralin		✗	✓		✓	✓	✗	✓	✓	✗	✗	✗	✓
Tincture of iodine		○	✓	✗			✓	✓	✓	○	✗	○	✓
Toluol	✓		✓			✓	✓	✓	✓	✗	✗	✗	○
Transformer oil	✓		✓		✓	✓	○	✓	✓	✗	✓	✗	✓
Trichloroethylene		✗	100 ✓	✓	○	✗	○	○	○	✗	✗	✗	✓
Triethanolamin			✓			✓	✓	✓	✓	○	✗	○	✗
Turpentine	✓	✓	✓		✗	✓	✓		○	✗	✗	✗	✓
Vaseline			✓			✓		✓	○	✗	✓	✗	✓
Vegetable juice	✓	✓	✓		✓	✓	✓	✓	✓	✓	✓	✓	✓
Vegetable oils	✓	✓	✓		✓	✗	✓	✓	✓	○	✓	○	✓
Vinegar	✓	✓	100 ✓	✓	✓	10 ✓	✓	✓	✓	25 ✓	✓	○	25 ○
Water and soap	✓	✓	✓		✓	✓	✓	✓	✓	✓	✓	✓	✓
Whisky	✓	✓	✓	✓	✓	✓	✓	✓	✓	✓	✓	✓	✓
Wine	✓	✓	✓	✓	✓	✓	✓	✓	○	✓	✓	✓	✓
Xilol	✓	✓	✓	○	✗	✓	✗	✓	✓	✗	✗	✗	✓

* Viton is believed to be the trademark and/or trade name of The Chemours Company FC, LLC and is not owned or controlled by Regal Beloit Corporation.

ABBREVIATION

- ✓ = good resistance
- = fairly good resistance depending on use conditions
- ✗ = insufficient resistance (not recommended)
- C = concentration
- SA = saturated
- blank spaces = no tests performed

All values are only applicable to temperatures below 21°C / 70°F.



MATERIALS AND CALCULATIONS - General index 7 3 5 1 0 a -

◀ back

7 3 5 6 0 a Steel chain materials

7 3 5 7 6 a Storage of plastic chains and belts & RoHs

7 3 5 8 0 a Coefficient of friction - Measurement procedure

7 3 5 7 3 a Nolu®-S parts

7 3 5 7 8 a Coefficient of friction of standard materials

7 3 5 8 8 a Application temperatures

Chains & sprockets	Wear strips	Side guide brackets & accessories	Levelers	Engineering manual
Modular belts & sprockets	Chain & belt return systems	Frame & structure supports	Bearing supports	
Curves & tracks	Side guide solutions	Miscellaneous products	Equipment	

7 3 5 8 8 a APPLICATION TEMPERATURES MATERIALS

For low and high temperature application please consult our Application Engineering department.

Be aware:

- If a chain, belt or other component is composed of several materials, all materials will have to be considered individually.
- Please note that the properties of a material change when the temperature changes
- In general, the impact resistance is reduced at low temperatures.
- The strength and wear resistance are reduced at elevated temperatures.
- High temperatures can also influence chemical resistance
- Some materials absorb moisture and expand/swell



MATERIAL	SYMBOL	USER FOR	MIN TEMP. °C	MAX. TEMP. °C		MIN TEMP. °F	MAX. TEMP. °F	
				DRY	WET		DRY	WET
Carbon steel	C45	Steel chains, roller chains	-70	180	not recommended	-95	350	not recommended
Ferritic stainless steel	Standard	Steel chains	-30	400	130	-20	750	265
Extra stainless steel	Extra	Steel chains	-30	400	130	-20	750	265
Extra plus stainless steel	Extra plus	Steel chains	-30	400	130	-20	750	265
Austenitic stainless steel	Austic	Steel chains, roller chains	-30	400	130	-20	750	265
Acetal resin	D,W	Plastic chains	-40	80	65	-40	175	150
Low friction acetal resin	LF (all colors)	Plastic chains and belts	-40	80	65	-40	175	150
Anti static acetal resin	AS	Plastic chains and belts	-40	80	not applicable	-40	175	not applicable
NG®evo conveyor components made from engineered plastic resin	NG®evo	Plastic chains and belts	-40	120	60	-40	250	140
Polypropylene	PP	Plastic chains and belts	5	104	104	41	220	220
Chemical resistant	CR	Plastic chains	5	104	104	41	220	220
Polyamide - PA High temperature resistance	HT	Plastic chains and belts	0	140	not applicable	30	285	not applicable
Polyphenylene sulfide Extra high temperature resistance	XT	Plastic chains and belts	-40	240	not applicable	-40	464	not applicable
Polyamide - PA Abrasion resistance	AR	Plastic chains	0	90	90	30	195	195
Thermoplastic rubber SEBS	TPR	VG chains and belts, gripper chains	-40	100	100	-40	210	210
NBR rubber	NBR	Gripper chains	-25	100	100	-15	210	210
EPDM rubber	EPDM	Gripper chains	-40	120	120	-40	250	250
EPDM-PP rubber	EPDM-PP	Gripper chains	-40	120	120	-40	250	250
Polyamide	PA	Sprockets, components	0	90	90	30	195	195
Polyamide reinforced	PA FV	Sprockets, bearing, components	0	90	90	30	195	195
Polypropylene	PP	Components	5	104	104	41	220	220
Polypropylene reinforced	PP FV	Bearing, components	5	104	104	41	220	220
Polyethylene	PE	Curves, components	-40	80	80	-40	175	175
Nolu®-S parts	Nolu®-S parts	Curves, components	-40	80	80	-40	175	175



MATERIALS AND CALCULATIONS - General index 7 3 5 1 0 a -

7 3 5 6 0 a Steel chain materials

7 3 5 7 6 a Storage of plastic chains and belts & RoHs

7 3 5 8 0 a Coefficient of friction - Measurement procedure

7 3 5 7 3 a Nolu®-S parts

7 3 5 7 8 a Coefficient of friction of standard materials

7 3 5 8 6 a Chemical resistance of standard materials

Chains & sprockets	Wear strips	Side guide brackets & accessories	Levelers	Engineering manual
Modular belts & sprockets	Chain & belt return systems	Frame & structure supports	Bearing supports	
Curves & tracks	Side guide solutions	Miscellaneous products	Equipment	

SYSTEM PLAST®



continue ▶

7 3 7 0 0 a NG® EVO CONVEYOR COMPONENTS MADE FROM ENGINEERED PLASTIC RESIN

NG®
evo

Plastic Chains & Modular Belts

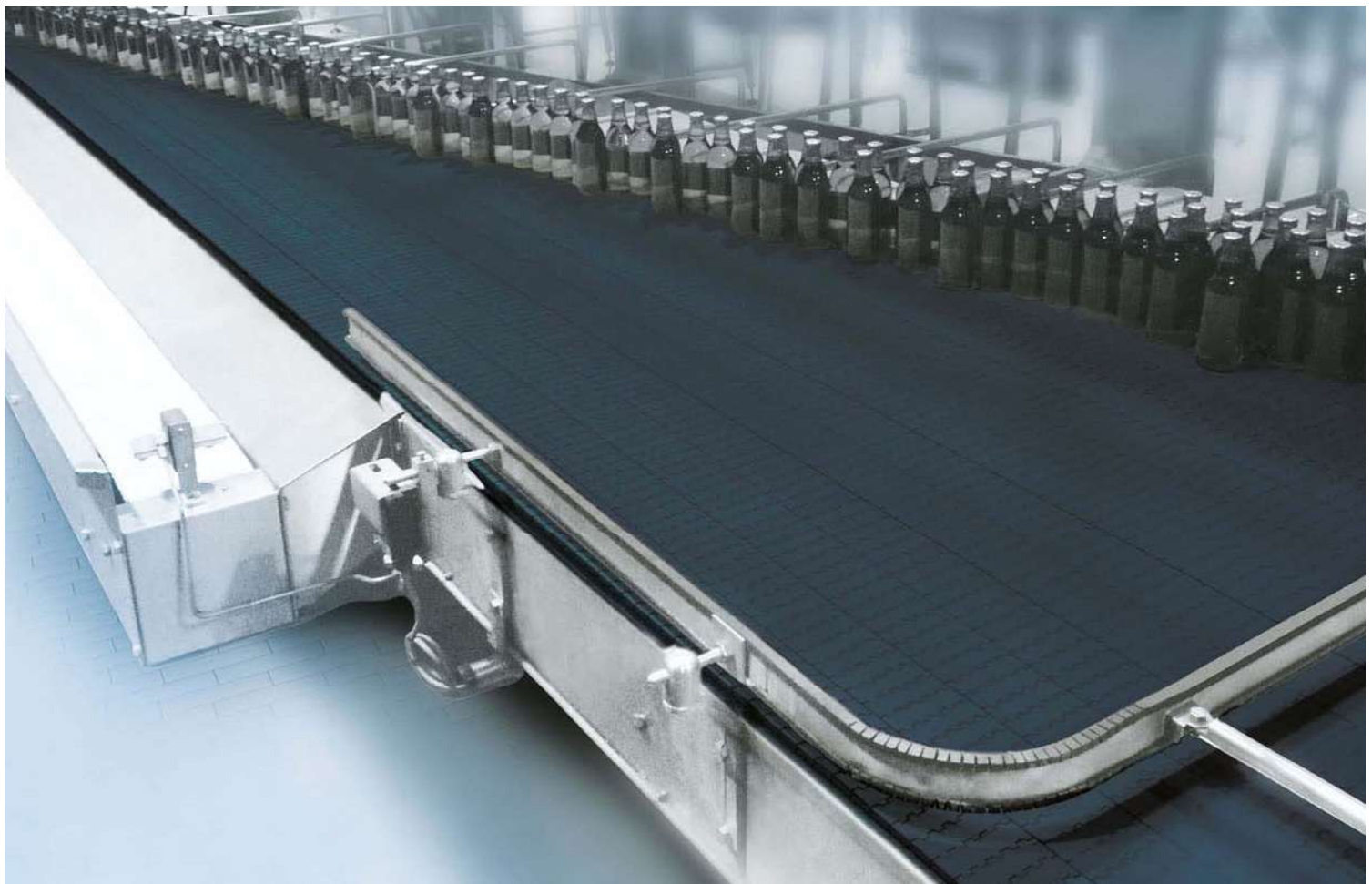

MATERIALS AND CALCULATIONS - General index **7 3 5 1 0 a -**

continue ▶

Revision 001



Chains & sprockets	Wear strips	Side guide brackets & accessories	Levelers	Engineering manual
Modular belts & sprockets	Chain & belt return systems	Frame & structure supports	Bearing supports	
Curves & tracks	Side guide solutions	Miscellaneous products	Equipment	



7 3 7 0 1 a NG® EVO CONVEYOR COMPONENTS MADE FROM ENGINEERED PLASTIC RESIN



WHAT PLASTIC MATERIALS ARE USED IN NEW GENERATION® CONVEYOR COMPONENTS?

The System Plast® New Generation® family of chains and belts conveyor components are made of proprietary engineered resins designed to provide a sustainable advantage over “industry standard” materials. Their reduced coefficient of friction properties enable end users to reduce or eliminate their chain/belt lubrication thus providing a true “dry running” conveyor. Better sliding properties also result in reduced power consumption, increased wear life, reduced dust generation and the ability to run at higher speeds.

SYSTEM PLAST PRODUCTS ARE LEADING THE WAY WITH INNOVATION!

We introduced the New Generation® brand of conveyor components 20 years ago. It was soon recognized to offer new possibilities for running conveyors lines without lubrication. This enabled the reduction/elimination of soap & water or dry lubricants creating a safer work environment and cost savings. NG® conveyor components have also proven they provide longer wear life in comparison to acetal materials, and reduce noise levels in dry applications.

Regal expertise with unique materials and in-house integrated tool development is critical for consistent control over design and manufacturing processes.

MATERIAL EVOLUTION TO MEET YOUR GOALS

Understanding the growing demands on safety, hygiene, sustainability and TCO (total cost of ownership) - Regal challenged itself to improve the original formulation. This successful development created a new and improved resin used to make NG® Evolution conveyor components which helps to meet your goals. Your floors can be drier, bacteria growth can be reduced, energy and water consumption can be less and your TCO will be improved.

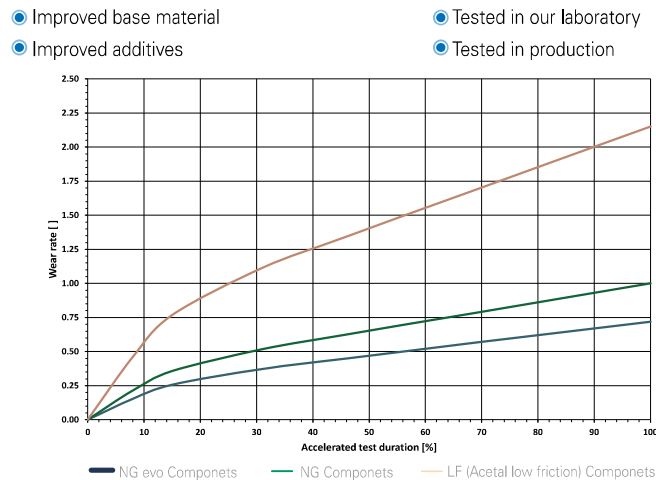

IMPROVEMENTS OF NG® EVO COMPARED TO NG® CONVEYOR COMPONENTS

- Lower friction - Friction is reduced up to 15%.
- Higher strength - Up to 10%
- Higher abrasion resistance
- Approved for direct food contact according to EU and FDA regulations



Chains & sprockets	Wear strips	Side guide brackets & accessories	Levelers	Engineering manual
Modular belts & sprockets	Chain & belt return systems	Frame & structure supports	Bearing supports	
Curves & tracks	Side guide solutions	Miscellaneous products	Equipment	

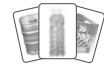

7 3 7 0 2 a NG® EVO CONVEYOR COMPONENTS MADE FROM ENGINEERED PLASTIC RESIN

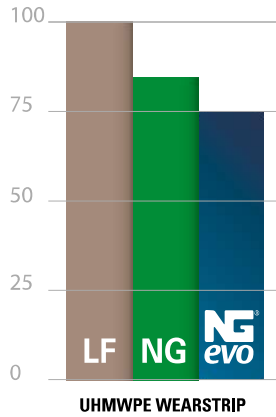

LOWEST COEFFICIENT OF FRICTION BETWEEN CHAIN /BELT AND WEARSTRIP

Coefficient of friction NG® evo conveyor components on UHMWPE wearstrip:

- 25% lower than LF acetal chain
- 15% lower than NG chain

Coefficient of friction values of 0,10 or even less are achievable in running dry applications

- Less power consumption
- Improved product stability
- Improved product flow
- Improved productivity

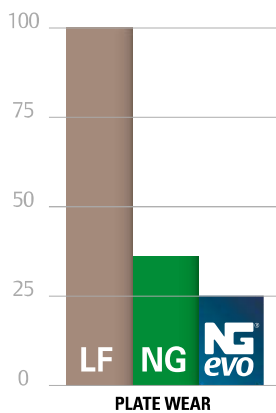

HIGHEST PLATE WEAR RESISTANCE

Plate wear in accelerated abrasion test after 5400 km run length

- 75% less wear than LF acetal chain
- 30% less wear than NG chain

Increased wear provides many advantages

- Less dust generation
- Reduced contamination
- Reduced cleaning requirements

NG® EVO CONVEYOR COMPONENTS ARE APPROVED FOR DIRECT FOOD CONTACT ACCORDING TO EU AND FDA REGULATIONS

NOISE REDUCTION:

With NG evo components the risk of noisy chains is greatly reduced compared to LF acetal chains. Squealing curves can be resolved and improve the work environment.

HIGH PV (PRESSURE VELOCITY) LIMIT:

With NG evo conveyor components, higher speeds and higher loads are achievable in dry running lines compared to LF Acetal chains. Additional speed and wear advantages can be also gained when used in combination with NOLU®-S or NOLU-SR curves.

CHEMICAL RESISTANCE:

NG evo conveyor components have a better chemical resistance than LF acetal materials, being compatible with most cleaning agents, especially in aseptic filling with the presence of H₂O₂ (hydrogen peroxide). The material in NG evo components, unlike many other materials used in the same application, do not get attacked by this chemical.



Chains & sprockets	Wear strips	Side guide brackets & accessories	Levelers	Engineering manual
Modular belts & sprockets	Chain & belt return systems	Frame & structure supports	Bearing supports	
Curves & tracks	Side guide solutions	Miscellaneous products	Equipment	



A SUCCESS STORY OF NG® CONVEYOR COMPONENTS



◀ back



DRY RUNNING SYSTEM PLAST® CONVEYOR COMPONENTS HELP HEINEKEN BREW A BETTER FUTURE WITH WATERLESS BOTTLING CONVEYORS IN ZOETERWOUE PLANT

THE TWO WATER FOOTPRINT NETWORK PARTNERS TEAM UP TO IMPROVE PLANT SAFETY AND SUSTAINABILITY BY REDUCING WATER USE, ENERGY CONSUMPTION, AND SOUND LEVELS AT ZOETERWOUE BREWERY.

Zoeterwoude, Netherlands 2014 - Heineken* N.V.'s global sustainability strategy, known as "Brewing a Better Future," produced a company-wide reduction of 20 percent in water use between 2008 and 2013. Playing a role in that improvement are System Plast NG® conveyor chain/belts and NOLU®-S wear track from System Plast S.r.l., a subsidiary of Regal Beloit Corporation (referred to from here on as "Regal"). The ultra-low-friction components, which are being deployed in phases at Heineken's Zoeterwoude brewery, eliminate the need for water and chemical-based lubrication on the filling lines - including those where abrasive particles from aluminum cans, party kegs and returnable glass bottles have been a problem in the past.

According to managers at the brewery, the dry running conveyor is producing a cascade of sustainability improvements with a cleaner, quieter, more energy-efficient and reliable plant. "We have experienced a wide variety of gains from the System Plast dry running conveyor," said Mr. Cok Duivenvoorden, Technical Line Manager at Zoeterwoude. "Specifically, we have improved plant safety and hygiene with dry equipment and floors. Maintenance is easier because of the cleanliness and better access where drip trays have been removed. We have reduced costs for water, lubricating chemicals and wastewater discharge. Dry operation is easier on conveyor bearings and frames, yet still reduces energy consumption because of the low-friction components. System Plast NG chain lasts up to five times longer than

low-friction acetal in some of our applications. And when installed to replace worn-out conveyor, the new chain pays for itself in as little as a year."

A JOINT GOAL TO REDUCE WATER USE IN BEVERAGE PROCESSING

One goal of Heineken's "Brewing a Better Future" sustainability program is to reduce water consumption by at least 25% by 2020, and both Heineken and Regal are pursuing dry conveying solutions as members of the Water Footprint Network. The network is a global organization of businesses, governmental agencies and environmental groups that promotes the transition to sustainable use of fresh water resources through increased awareness of how production and consumption of goods affect fresh water systems.



*Heineken is believed to be a trademark and/or trade name of Heineken Brouwerijen B.V. and is not owned or controlled by Regal Beloit Corporation.

◀ back

Chains & sprockets	Wear strips	Side guide brackets & accessories	Levelers	Engineering manual
Modular belts & sprockets	Chain & belt return systems	Frame & structure supports	Bearing supports	
Curves & tracks	Side guide solutions	Miscellaneous products	Equipment	



7 3 9 9 5 a APPLICATION CONSIDERATIONS

The proper selection and application of power transmission products and components, including the related area of product safety, is the responsibility of the customer. Operating and performance requirements and potential associated issues will vary appreciably depending upon the use and application of such products and components. The scope of the technical and application information included in this publication is necessarily limited. Unusual operating environments and conditions, lubrication requirements, loading supports, and other factors can materially affect the application and operating results of the products and components and the customer should carefully review its requirements. Any technical advice or review furnished by Regal Beloit America, Inc. and its affiliates with respect to the use of products and components is given in good faith and without charge, and Regal assumes no obligation or liability for the advice given, or results obtained, all such advice and review being given and accepted at customer's risk.

For a copy of our Standard Terms and Conditions of Sale, Disclaimers of Warranty, Limitation of Liability and Remedy, please contact Customer Service.

These terms and conditions of sale, disclaimers and limitations of liability apply to any person who may buy, acquire or use a Regal Beloit America Inc. product referred to herein, including any person who buys from a licensed distributor of these branded products.

INSPECTION AND MAINTENANCE 73010a

72110a CONSTRUCTION DETAILS

APPLICATIONS 72510a

73510a MATERIALS AND CALCULATIONS



Chains & sprockets	Wear strips	Side guide brackets & accessories	Levelers	Engineering manual
Modular belts & sprockets	Chain & belt return systems	Frame & structure supports	Bearing supports	
Curves & tracks	Side guide solutions	Miscellaneous products	Equipment	

Item description	Page code	Item description	Page code	Item description	Page code	Item description	Page code
1400..D	11590a	820..WL	11050a	BKR-77W43P..	53535a	CL-RD8-PD..	51650a
1400..R	11590a	820..WML	11050b	BKR-77W43S..	53535a	CL-RD8-PF	51650a
1400V..R	11600a	820..WMS	11050b	BKR-84W31LP..	53525b	CON..	50600a
1700..D	11550a	820..WS	11050a	BKR-85W44P..	53545b	CON-H7816M-S	51690a
1700..DMS	11550a	821..D	11320b	BKR-87W31LP..	53525b	CON-H8716M-S	51700a
1700..RB	11560a	821..R	11320b	BKR-88W43P..	53535b	CRBFTRS..	56044a
1700..RC	11560a	821..W	11320b	BKR-93W43LP..	53535b	CRBFTRS..	56074a
1700..RM	11550a	821..WMS	11320b	BKZ-154-SS	53580a	CS..	56100a
1700..RMS	11550a	878..D	11270a	BPS-4020..	54040a	CSHOE..	50600a
1874..	11140a	878..RB	11270a	CAP-10M..	53605a	DS-25M52	54520a
1874..	11450a	878..RC	11270a	CAP-25M..	54530a	DS-30M52	54520a
2080..DM	30027a	880..DMS	11260a	CAP-30M..	54530a	DTS..	53600a
2080..DMS	30027a	880..DS	11260a	CAP7023-P-YT	56300b	F-100..	51090a
2120..	30160a	880..RMS	11260a	CAP7023-B30M..	56300b	F-26..	51090a
2120..DS-PK2	30160c	880..RS	11260a	CAP8437-P-YT	56300b	F-50..	51090a
2122..	30166a	880T..W	11260d	CAP-8437-B40M..	56300b	F-60..	51090a
2124..	30165a	880T..WMS	11260d	CAP-50M..	54530a	F-70..	51090a
2190..	30235a	881..DMS	11090a	CC-16..	53610a	F-90..	51090a
2250..	30395a	881..DS	11090a	CC-19-12MK-12MK	53620a	FT-HDL..	54560a
2251..	30550a	881..RMS	11090a	CC-20..	53620a	FT-LOCK..	54570a
2256..	30740a	881..RS	11090a	CC-25-12MK..	53620a	FT-MAG..	54570a
2256ST..	30740b	881T..W	11090b	CC-25-14M..	53615a	FLSHOE-S330	50600b
2260..	30715a	881T..WMS	11090b	CC-25-15M..	53615a	GNP..	56300a
2260..DS-PK2	30715b	882..DMS	11300a	CC-25-16M..	53615a	GP..	54540a
2351..	30760a	882..DS	11300a	CC-25-18M..	53615a	GRINGK..	11090d
2500..	30615a	882..RMS	11300a	CC-25-20M..	53615a	GRP.EPDM	11440b
2502..	30618a	882..RS	11300a	CC-42-12MK..	53620a	GRP.NBR	11440a
2508..	30640a	882T..W	11300b	CC-42-12MQ..	53630a	GRPK.NBR	11440a
2630..	30650a	BCK..	50600a	CC-52-R..	53650a	GRPN..NBR	11430a
500..	56300b	BEC-19	56044a	CC-52-S..	53645a	GRSHOE-S330	50600b
515..DMS	11130a	BEC-24	56074a	CJ..	54520a	HDL-117..	54560a
515..RMS	11130a	BEO-19	56044a	CL..	56090a	HDL-120..	54560a
600..RM	11580a	BEO-24	56074a	CL-1020S	52550a	HDL-94..	54560a
800..DMS	11120a	BK-47W44..	53545b	CL-1540S	52530a	HNG..	54550a
800..DMS-F	11120b	BK-49W31L	53525b	CL-6065X38	50600a	HUB110..	11270a
800..DMS-FSS	11120b	BK-50W43	53535b	CL-CON-P..	51600a	ICOF-CAN	57080a
800..RMS	11120a	BK-55W43L	53535b	CL-CON-P25..	51630a	ICOF-GLASS	57080a
800..WMS	11120b	BKE-85W22..	53555a	CL-CON-PD..	51610a	ICOF-PET	57080a
800..FSS	11120b	BKF-35W31L..	53555a	CL-CON-R	51820a	ICOF-SLIDER-CAN	57080a
815..D	11040a	BKF-61W38..	53560a	CL-D..	51660a	ICOF-SLIDER-GLASS	57080a
815..DMS	11040b	BKF-65W30L..	53555a	CL-H45S	52521a	ICOF-SLIDER-PET	57080a
815..DMS-F	11090d	BKF-66W31L..	53515a	CL-H5210..	52594a	IND-142B..	53635a
815..DS	11040a	BKF-66W31L..	53515b	CL-H7816M..	51690a	IND-350R..	53635a
815..FSS	11090d	BKF-79W30..	53555a	CL-H8716M..	51700a	MODFLEX...A90R	57035a
815..RMS	11040b	BKF-89W38..	53560a	CL-H9014M..	51680a	MODFLEX...A180R	57055a
8157..DMS	11100a	BKL..SS	53580a	CL-RD10-P..	51640a	MODFLEX...A90L	57040a
8157..DMS-F	11100b	BKR-67W44P..	53545b	CL-RD10-P258M	51650a	MODFLEX...A180L	57060a
8157..FSS	11100b	BKR-69W31LP..	53525a	CL-RD10-PD..	51650a	MODFLEX...A90R-TM	57045a
820..D	11200a	BKR-69W31LP..	53525b	CL-RD12-P..	51640a	MODFLEX...A180R-TM	57065a
820..DM	11200b	BKR-69W31LS..	53525a	CL-RD12-P258M	51650a	MODFLEX...A90L-TM	57050a
820..DMS	11200a	BKR-69W44P..	53545a	CL-RD12-PD..	51650a	MODFLEX...A180L-TM	57070a
820..DS	11200a	BKR-69W44S..	53545a	CL-RD14-P..	51640a	MODSORT-AI2..	57015a
820..RM	11200b	BKR-70W43P..	53535b	CL-RD14-P258M	51650a	MODSORT-MSGK...	57020a
820..RMS	11200b	BKR-72W43P..	53535a	CL-RD20-P..	51640a	MODSORT-MPES..	57020a
820..RS	11200b	BKR-72W43S..	53535a	CL-RD8-P..	51640a	MODSORT-MPEK	57020a
820..W	11050a	BKR-75W43LP..	53535b	CL-RD8-P258M	51650a	MODSORT-MPS...	57020a

Legend

Codes ending with .. indicate a group of item descriptions all starting with the code listed. Example: 2122.. (all item descriptions starting with 2122).
 Codes with .. in the middle indicate a group of item descriptions starting and ending with the codes listed. Example 2251..RS (all item descriptions starting with 2251 and ending with RS). **Information about item descriptions, printed in blue, is only available on our website: www.SystemPlastSmartGuide.com**

Chains & sprockets	Wear strips	Side guide brackets & accessories	Levelers	Engineering manual
Modular belts & sprockets	Chain & belt return systems	Frame & structure supports	Bearing supports	
Curves & tracks	Side guide solutions	Miscellaneous products	Equipment	

Item description	Page code	Item description	Page code	Item description	Page code	Item description	Page code
KMD01..	50050a	KNF-50H56..	54600a	LF879TAB..	11230a	LFG2251FT-P.VG-3	30490c
KMD02..	50050a	KNF-53H45..	54600a	LF880..	11240a	LFG2251FT-PT.VG	30490d
KMD03..	50020a	KNF-80H51..	54600a	LF8800P..	11240b	LFG2251FT-PT.VG-2	30490d
KMD04..	50020a	KNM-20H13..	54610a	LF880M..	11220a	LFG2251FT-PT.VG-3	30490d
KMD05..	50050a	KNM-25H16..	54610a	LF880TAB..	11230a	LFG2251FT-PT.VGS	30495d
KMD06..	50020a	KNM-30H21..	54610a	LF882M..	11280a	LFG2251FT-PT.VGS-2	30495d
KMD07..	50020a	KNM-40H26..	54610a	LF882TAB..	11290a	LFG2251FT-PT.VGS-3	30495d
KMD08..	50020a	KNM-50H32..	54610a	LFB2080FT..	30025a	LFG2251FT-TAB..	30710a
KMD09..	50020a	KNM-50H40..	54600a	LFB2120FG..	30070a	LFG2251LBP..	30500a
KMD10..	50020a	LA100..	55585a	LFB2120FT..	30050a	LFG2252PT..	30481a
KMD11..	50030a	LA100..	55825a	LFB2250FG..	30360a	LFG2253FT..	30330a
KMD12..	50030a	LA100-SH..	55810a	LFB2250FT..	30325a	LFG2260FT-M..	30700a
KMD21..	50040a	LA110..	55600a	LFB2253FT..	30330a	LFG2351..	30745a
KMD22..	50040a	LA120E-02B..	55645a	LFB2253RT..	57015a	LFG2351..VG	30755a
KMD23..	50040a	LA123H-02B..	55645a	LFB2253RTC..	30398a	LFG2451TAB..	30750a
KMD24..	50080a	LA40..	55525a	LFB2256..	30730a	LFG2508FTS..	30620a
KMD25..	50080a	LA50..	55540a	LFB2256..VG	30735a	LFG2551..	30745a
KMD26..	50080a	LA60..	55555a	LFG1700	11530a	LFG2630FTS..	30645a
KMD27..	50080a	LA60-01..	55630a	LFG1702	11530a	LFG2651TAB..	30750a
KMD28..	50080a	LA60H-01..	55630a	LFG1710..	11540a	LFG-COMB2500..	30615a
KMD31..	50040a	LA60S-01..	55630a	LFG1710-CTAB..	11540a	LFM30..	55750a
KMD32..	50040a	LA80..	55570a	LFG2120FG..	30070a	LFM40..	55750a
KMD33..	50040a	LA80H..	55570a	LFG2120FT..	30050a	LFM50..	55750a
KMD37..	50040a	LA80S..	55780a	LFG2120FT-PT..	30060b	NGE1400V..TAB	11600a
KMD39..	50060a	LAF100SH-01..	55630a	LFG2120FT-PT.VG-2	30100d	LFW1400..	11590a
KMD40..	50060a	LAF123H..	55840a	LFG2120FT-PT.VG-3	30100d	LFW1400V..TAB	11600a
KMD41..	50060a	LAF123H-02B..	55660a	LFG2120FT-PT2..	30060b	LFW1431..	11590a
KMD42..	50060a	LAS100..	55615a	LFG2250FG..	30360a	LFW1700	11530a
KMD48..	50060a	LAS120..	55615a	LFG2260FG-M..	30700a	LFW1701-TAB	11530a
KMD52..	50060a	LAS80..	55615a	LFG2250FG-PT..	30360c	LFW1702	11530a
KMD61..	50050a	LAX100..	55810a	LFG2250FG-PT2..	30360c	LFW1710..	11540a
KMD62..	50050a	LAX102..	55795a	LFG2250FT..	30325a	LFW1710-CTAB..	11540a
KMD64..	50101a	LAX123..	55840a	LFG2250FT..VG	30370a	LFW600..	11570a
KMD66..	50101a	LAX123-02B..	55660a	LFG2250FT..VG-2	30370b	LFW600F	11580a
KMD68..	50070a	LB100	55735a	LFG2250FT..VG-3	30370b	LFW631 TAB	11580a
KMD71..	50070a	LB150	55735a	LFG2250FT..VGS	30380a	LMM120..	55720a
KMD78..	50070a	LB200	55735a	LFG2250FT..VGS-2	30380b	LMM80..	55720a
KMD82..	50070a	LB80	55735a	LFG2250FT..VGS-3	30380b	LMP125..	55705a
KMD84..	50101a	LF1700	11530a	LFG2250FT-K330	30310a	LMP80..	55705a
KMD85..	50101a	LF1701-TAB	11530a	LFG2250FT-PT..	30335b	LMPH123..	55735a
KMD86..	50101a	LF1702	11530a	LFG2250FT-PT..VG	30370d	LSHOE-S330	50600b
KMD87..	50101a	LF1843 SS TAB..	11470a	LFG2250FT-PT..VG-2	30370d	LSS100..	55675a
KMD88..	50101a	LF1843 TAB..	11470a	LFG2250FT-PT..VG-3	30370d	LSS125..	55675a
KMD90..	50091a	LF820..	11190a	LFG2250FT-PT2..	30335b	LSS50..	55675a
KMD91..	50091a	LF820P..	11190a	LFG2250FT-PT-K330	30310a	LSS75..	55675a
KMD92..	50091a	LF821..	11320a	LFG2250FT-TAB..	30710a	LSSC100..	55690a
KMD93..	50091a	LF8257..	11310a	LFG2251FT..	30440a	LSSC125..	55690a
KMD96..	50091a	LF828..	11210a	LFG2251FT..VG	30490a	LSSC75..	55690a
KMD97..	50101a	LF831..	11190a	LFG2251FT..VG-2	30490b	SNB2080..	30029a
KNF-30H21..	54610a	LF843..	11460a	LFG2251FT..VG-3	30490b	NB2120..	30175a
KNF-40H26..	54610a	LF845..	11460a	LFG2251FT..VGS	30495a	SNB2120..	30175a
KNF-50H32..	54610a	LF877TAB..	11230a	LFG2251FT..VGS-2	30495b	NGD1873TAB..VG	11420a
KNF-50H39..	54600a	LF878TAB..	11230a	LFG2251FT..VGS-3	30495b	NGE1400..	11590a
KNF-50H40..	54600a	LF879..	11240a	LFG2251FT-M..	30700a	NGE1431..	11590a
KNF-50H41..	54600a	LF8790P..	11240b	LFG2251FT-P.VG	30490c	NGE1700	11530a
		LF879M..	11220a	LFG2251FT-P.VG-2	30490c	NGE1701-TAB	11530a

Legend

Codes ending with .. indicate a group of item descriptions all starting with the code listed. Example: 2122.. (all item descriptions starting with 2122).

Codes with .. in the middle indicate a group of item descriptions starting and ending with the codes listed. Example 2251..RS (all item descriptions starting with 2251 and ending with RS). **Information about item descriptions, printed in blue, is only available on our website: www.SystemPlastSmartGuide.com**

Chains & sprockets	Wear strips	Side guide brackets & accessories	Levelers	Engineering manual
Modular belts & sprockets	Chain & belt return systems	Frame & structure supports	Bearing supports	
Curves & tracks	Side guide solutions	Miscellaneous products	Equipment	

Item description	Page code	Item description	Page code	Item description	Page code	Item description	Page code
NGE1702	11530a	NGE2250FG-P2..	30360b	NGE880..	11240a	R-60..83-PEG	51080a
NGE1863 TAB..	11490a	NGE2250FG-P-K330	30340a	NGE8800..	11240b	R-60..85-PEB-S	51110a
NGE1863SS TAB..	11490a	NGE2250FG-PT..	30360c	NGE8800P..	11240b	R-60..85-PEG	51080a
NGE1873SS TAB..	11470a	NGE2250FG-PT.T	30350a	NGE880M..	11220a	R-9B4..	52680a
NGE1873SS TAB..GS	11440b	NGE2250FG-PT2..	30360c	NGE880TAB..	11230a	RF-11B4..	52680a
NGE1873SS TAB..GS..	11440a	NGE2250FT..	30325a	NGE880TAB..VAC43X2	11235a	RF-17B6..	52680a
NGE1873SS TAB..VG	11420a	NGE2250FT-K330	30310a	NGE882LBP TAB..	11360a	RF-21B6..	52680a
NGE1873SS TAB..VG85QH8.5	11425a	NGE2250FT-P..	30335a	NGE882LBP..	11360a	RF-24B6..	52680a
NGE1873TAB..	11470a	NGE2250FT-P2..	30335a	NGE882M..	11280a	RF-40..86-PEG	51080a
NGE1873TAB..GS	11440b	NGE2250FT-PT..	30335b	NGE882M..VG	11400a	RF-41..B	51020a
NGE1873TAB..GS..	11440a	NGE2250FT-PT..T	30320a	NGE882TAB..	11290a	RF-41..G	51060a
NGE1873TAB..VG	11420a	NGE2250FT-PT2..	30335b	NGE882TAB..VG	11400a	RF-47..G	51030a
NGE2080FT..	30025a	NGE2250FT-PT-K330	30310a	NGE-S-K38..	11330a	RF-50..28-PEG	51040a
NGE2120FG..	30070a	NGE2250FT-PT-K330T	30320a	PAB-COMB2500..	30615a	RF-50..43-PEG	51050a
NGE2120FG-P..	30075a	NGE2250FT-TAB..	30710a	PC-125110..	53640a	RF-50..86-PEG	51080a
NGE2120FG-P2..	30075a	NGE2251FT..	30440a	PC-25..	53610a	RF-50..B	51030a
NGE2120FG-PT..	30075b	NGE2251FT-K330	30420a	PC-25T..	54530a	RF-60..43-PEG	51050a
NGE2120FG-PT2..	30075b	NGE2251FT-M..	30700a	PC-30T..	54530a	RF-60..86-PEG	51080a
NGE2120FT..	30030a	NGE2251FT-PT..	30450b	PC-9075..	53635a	RF-60..G	51030a
NGE2120FT..	30050a	NGE2251FT-PT..T	30430a	PC-KIT	53640a	RG-105H..	52570a
NGE2120FT..GB	30120a	NGE2251FT-PT..TL	30430a	PC-KIT-0M	53605a	RG-105H49..3000A	52572a
NGE2120FT..GB-2	30120b	NGE2251FT-PT-K330	30420a	PC-KIT-19M	53605a	RG-105H49..3000S	52571a
NGE2120FT..GB-3	30120b	NGE2251FT-TAB..	30710a	PCO-H7816M-B	51690a	RG-105H49..348	52590a
NGE2120FT..VG50	30100a	NGE2251LBP..	30500a	PCO-H8716M-B	51700a	RG-105H52..3000S	52594a
NGE2120FT..VG50-2	30100b	NGE2251LBP-P..	30500b	PCO-H9014M-G	51680a	RG-105H81..3000A	52572a
NGE2120FT..VG50-3	30100b	NGE2252FT..	30445a	P-D..	51830a	RG-105H81..3000S	52571a
NGE2120FT..VGS50	30105a	NGE2252FT..	30420a	PE..	51830a	RG-165..	52520a
NGE2120FT-P..	30060a	NGE2252FT-PT..	30420a	PEN-H7816M-B	51690a	RG-210H50..	52570a
NGE2120FT-P..VG50	30100c	NGE2253FT..VAC43	30398n	PEN-H8716M-B	51700a	RG-210H50..3000A	52572a
NGE2120FT-P2..	30060a	NGE2260FT-M..	30700a	PEN-H9014M-G	51680a	RG-210H50..3000S	52571a
NGE2120FT-PT..	30030b	NGE600..	11570a	PF..	51830a	RG-240..	52521a
NGE2120FT-PT..	30060b	NGE820..	11190a	PG..	51830a	RG-240H45..3000S	52530a
NGE2120FT-PT..T	30045a	NGE820P..	11190a	PK-D12M110	51830a	RG-86H..	52570a
NGE2120FT-PT..VG50	30100d	NGE821..	11320a	PM10..	51830a	RG-86H49..3000A	52572a
NGE2120FT-PT2..	30060b	NGE821..VG	11410a	PMB..	54530a	RG-86H49..3000S	52571a
NGE2120LBP..	30110a	NGE821LBP..	11370a	PP1873SS TAB..GS..	11440b	RG-86H49..348	52590a
NGE2120M..	30720a	NGE8257..	11310a	PPW2502DT..	30617a	RG-86H81..3000A	52572a
NGE2121FT..	30030a	NGE8257..VG	11410a	PP878TAB..GS..	11430b	RG-86H81..3000S	52571a
NGE2121FT..	30055a	NGE8257LBP..	11370a	PPG2500RR..	30610a	RG-86H81..3000S	52571a
NGE2121FT-PT..	30030b	NGE828..	11210a	R-26..B	51020a	RG..	52550a
NGE2122FG..	30073a	NGE831..	11190a	R-26..G	51060a	RGC18-86H49..	52592a
NGE2124FT..	30030a	NGE831..VG	11380a	R-40..83-PEB-S	51110a	RGC20-105H49..	52592a
NGE2124FT..VG	30090a	NGE831LBP..	11340a	R-40..83-PEG	51080a	RGC32-86H49..	52593a
NGE2124FT-PT..	30030b	NGE863..	11460a	R-40..85-PEG	51080a	RGC33-105H49..	52593a
NGE2124FT-PT..VG	30090a	NGE877TAB..	11230a	R-41..B	51020a	RH-45..	54620a
NGE2190FG..	30230a	NGE878LBP..	11350a	R-41..G	51060a	RH-65..	54620a
NGE2190FG..	30220a	NGE878TAB..	11230a	R-49..G	51040a	RH-80..	54620a
NGE2190FG-PT..	30220a	NGE878TAB..GS..	11430b	R-50..27-PEG	51040a	RPAD10004	55810a
NGE2190FT..	30210a	NGE878TAB..GS..	11430a	R-50..41-PEG	51050a	RPAD10108	55600a
NGE2190FT..	30200a	NGE878TAB..VG	11390a	R-50..43-PEG	51050a	RPAD11207	55615a
NGE2190FT-PT..	30200a	NGE879..	11240a	R-50..83-PEB-S	51110a	RPAD11207	55645a
NGE2190FT-PT..T	30215a	NGE879LBP TAB..	11350a	R-50..83-PEG	51080a	RPAD12208	55660a
NGE2250FG..	30360a	NGE879M..	11220a	R-50..85-PEB-S	51110a	RPAD12208	55645a
NGE2250FG-K330	30340a	NGE879M..VG	11380a	R-50..85-PEG	51080a	RPAD12208	55840a
NGE2260FG-M..	30700a	NGE879TAB..	11230a	R-60..41-PEG	51050a	RPAD12506	55705a
NGE2250FG-P..	30360b	NGE879TAB..VG	11390a	R-60..83-PEB-S	51110a	RPAD12506	55720a

Legend

Codes ending with .. indicate a group of item descriptions all starting with the code listed. Example: 2122.. (all item descriptions starting with 2122).

Codes with .. in the middle indicate a group of item descriptions starting and ending with the codes listed. Example 2251..RS (all item descriptions starting with 2251 and ending with RS). **Information about item descriptions, printed in blue, is only available on our website: www.SystemPlastSmartGuide.com**

Chains & sprockets	Wear strips	Side guide brackets & accessories	Levelers	Engineering manual
Modular belts & sprockets	Chain & belt return systems	Frame & structure supports	Bearing supports	
Curves & tracks	Side guide solutions	Miscellaneous products	Equipment	

Item description	Page code	Item description	Page code	Item description	Page code	Item description	Page code
RPAD3206	55525a	SP-10944T15	53545a	TCHD-R150-R150-S	54080a	TTM87..	50101a
RPAD4206	55540a	SP-11253T15	53545a	TC-R150-S	54080a	TTM90..	50091a
RPAD5207	55630a	SP-7550..	53515a	TEE..	54080a	TTM91..	50091a
RPAD5306	55555a	SP-R36T..	53535a	TEE-3815-BM10	54080a	TTM92..	50091a
RPAD7207	55615a	SPSL815..	11020a	TEE-4415-BM10	54080a	TTM93..	50091a
RPAD7207	55570a	SPSL881MO..	11060a	TEE-4815-BM10	54080a	TTM96..	50091a
RPAD8006	55705a	SPT-10..	51160a	TE-R..	55765a	TTM97..	50101a
RPAD8006	55720a	SPT-11L..	51130a	TE-S..	55765a	TTMK..	50565a
RPAD9308	55585a	SPT-15..	51150a	TME..	52670a	TUBE-R10S-6000	53605a
RPAD9308	55795a	SPT-16..	51160a	TME-K..	52671a	TWP-S4030..	55765c
RPAD9308	55615a	SPT-2..	51130a	TOP-20P	53585a	UC..	56300a
RPAD9308	55825a	SPT-4..	51130a	TOP-23P..	53585a	UCFB..	56140a
RR-47..83-PEB-S	51110a	SPT-4..	51160a	TOP-23S..	53585a	UCFG..	56080a
RR-47..83-PEG	51080a	SPT-84..	51120a	TOP-24P..	53585a	UCFH..	56020a
RR-47..85-PEB-S	51110a	SPT-84..	51160a	TOP-24S..	53585a	UCFH..	56030a
RR-47..85-PEG	51080a	SQL..	56130a	TOP-25S..	53585a	UCFH..	56042a
RR-57..27-PEG	51040a	SR800..	11120a	TOP-40P..	53585a	UCFH..ME..	56040a
RR-57..41-PEG	51050a	SS802..	11120a	TOP-40S..	53585a	UCFHXX..	56042a
RR-57..43-PEG	51050a	SS812..	11030a	TOP-60S..	53585a	UCFL..	56020a
RR-57..83-PEB-S	51110a	SS881M..	11060a	TOP-90S..	53585a	UCFL..ME..	56040a
RR-57..83-PEG	51080a	SS881MO..	11060a	TTM01..	50050a	UFLX..	56020a
RR-57..85-PEB-S	51110a	SSA805..	11120a	TTM02..	50050a	UFLQ..	56072a
RR-57..85-PEG	51080a	SSA815..	11030b	TTM03..	50020a	UFLZ..ME..	56040a
RR-67..41-PEG	51050a	SSA8810..	11080a	TTM04..	50050a	VG-009M-01	51630a
RR-67..83-PEB-S	51110a	SSA8810TAB..	11070a	TTM05..	50030a	VG-011..	51620a
RR-67..83-PEG	51080a	SSE515..	11130a	TTM06..	50020a	VG-012-01	51620a
RR-67..85-PEB-S	51110a	SSE805..	11120a	TTM07..	50020a	VG-013..	51620a
RR-67..85-PEG	51080a	SSE805..VG	11180a	TTM08..	50020a	VG-016-02	51630a
RRF-40..86-PEG	51080a	SSE815..	11030a	TTM09..	50020a	VG-018M..	51630a
RRF-50..86-PEG	51080a	SSE8157..	11100a	TTM10..	50020a	VG-022-01	51630a
RRF-57..28-PEG	51040a	SSE8157..VG	11180a	TTM11..	50030a	VG-113SM-08G	51820a
RRF-57..43-PEG	51050a	SSE8157TAB..VG	11180a	TTM12..	50030a	VG-1568M..	52611a
RRF-60..86-PEG	51080a	SSE8810..	11080a	TTM21..	50040a	VG-213..	53565a
RRF-67..43-PEG	51050a	SSE881..VG	11170a	TTM22..	50040a	VG-213R-TOP..	53590a
RSHOE-S330	50600b	SSE881M..	11060a	TTM23..	50040a	VG-222JO..	51810a
S800..	11030b	SSE881MO..	11060a	TTM31..	50040a	VG-223R..	53565a
S815..	11030b	SSE881MO..	11160a	TTM32..	50040a	VG-223R-TOP..	53590a
SCREW21M5-SS	30615a	SSE8810..	11080a	TTM33..	50040a	VG-245..	53575a
SF-CD1..	54540a	SSE8810TAB..	11070a	TTM37	50040a	VG-253..	53570a
SF-SPS..	54540a	SS8810TAB..	11070a	TTM39..	50060a	VG-254..	53570a
SHOE-15L105..	51150a	SSE881RTAB..	11070a	TTM40..	50060a	VG-3050..	54020a
SHOE-48..	52611a	SSE881TAB..VG	11170a	TTM41..	50060a	VG-3051..	54050a
SHOE-49L26	52592a	SSE8857M..	11110a	TTM42..	50060a	VG-3052..	54050a
SHOE-49L42	52593a	SSE8857M..VG	11160a	TTM48..	50060a	VG-3055..	54050a
SHOE-53L102..	51150a	SSE8857TAB..	11110a	TTM52..	50060a	VG-3070..	54060a
SHOE-84L244..	51170a	SSEL815..	11020a	TTM61..	50050a	VG-3080..	54060a
SHOE-84L68..	51160a	SSEL815..	11030a	TTM62..	50050a	VG-3087..	54060a
SHOE-85L244..	51170a	SSEL881MO..	11060a	TTM64..	50101a	VG-3110..	54070a
SHOE-88L244..	51170a	SSER814..VG	11150a	TTM66..	50101a	VG-3115..	54070a
SHOE-89L152..	51170a	SSER815..VG	11150a	TTM68..	50070a	VG-60..	53615a
SHOE-94..	52611a	SSER815TAB..VG	11150a	TTM71..	50070a	VG-619..	53610a
SK38..DMS	11330a	SSL812..	11030a	TTM78..	50070a	VG-620..	53615a
SK38..RMS	11330a	SSL881MO..	11060a	TTM82..	50070a	VG-632..	54560a
SMB-60..	53625a	SSSR815..	11030a	TTM84..	50101a	VG-633..	54550a
SP-10049..	53535a	TC-20..	53610a	TTM85..	50101a	VG-634..	54550a
		TC-60..	53625a	TTM86..	50101a	VG-641T..	53590a

Legend

Codes ending with .. indicate a group of item descriptions all starting with the code listed. Example: 2122.. (all item descriptions starting with 2122).

Codes with .. in the middle indicate a group of item descriptions starting and ending with the codes listed. Example 2251..RS (all item descriptions starting with 2251 and ending with RS). **Information about item descriptions, printed in blue, is only available on our website: www.SystemPlastSmartGuide.com**

Chains & sprockets	Wear strips	Side guide brackets & accessories	Levelers	Engineering manual
Modular belts & sprockets	Chain & belt return systems	Frame & structure supports	Bearing supports	
Curves & tracks	Side guide solutions	Miscellaneous products	Equipment	

Item description	Page code	Item description	Page code	Item description	Page code	Item description	Page code
VG-686A-1.25-3M	52611a	VG-JSL075-125..	50530a	VG-Q-75-40..	53595a		
VG-687-1.4-3M	52612a	VG-JSL075-188..	50530b	VG-QSC..	53595a		
VG-687-3.3-3M	52612a	VG-L20M..	50520a	VG-QT-01	53595a		
VG-687FLEX-1.4-3M	52610a	VG-LGSF..	51520a	VG-S1020M..	51660b		
VG-687H-1.4-3M	52611a	VG-LGSR..	51520a	VG-S1040M..	50560a		
VG-687H-3.3-3M	52611a	VG-LGST..	51520b	VG-S330M..	50580a		
VG-687LDB-M8	52612a	VG-LSSF..	51520a	VG-S4-330M..	50580a		
VG-687NP-1.4M	52612a	VG-LSSM..	51520a	VG-S4P330C..	50580b		
VG-687SP	52611a	VG-LSSMT..	51520c	VG-S4-S3020..	50550a		
VG-688-1.4-3M	52614a	VG-LSSR..	51520a	VG-S640M..	50560a		
VG-688-3.3-3M	52614a	VG-LSST..	51520b	VG-S840M..	50560a		
VG-688FLEX-1.4-3M	52610a	VG-LSST..	51520a	VG-SC..	54630a		
VG-688H-1.4-3M	52613a	VG-LSST..	51520c	VG-SCL..	54630a		
VG-688H-3.3-3M	52613a	VG-LSSWF..	51520a	VG-SD..	51660a		
VG-750-10	50550b	VG-LSSWF..	51520b	VG-SP1040M..	50560a		
VG-A2520..	51740b	VG-MBG-50-NS-10	50570a	VG-SP330C..	50580b		
VG-A330M..	50580a	VG-NG110..	51720a	VG-SP640M..	50560a		
VG-A600A..	51740a	VG-NG125..	51720a	VG-SP840M..	50560a		
VG-A840..	52650a	VG-NG47..	51720a	VG-SSF-HT-10	51520a		
VG-ABG..	51730a	VG-NG49..	51720a	VG-SSMT..	51520c		
VG-AP330C..	50580b	VG-NG50..	51720a	VG-SSTS..	51520b		
VG-BP..	54030a	VG-NG81..	51720a	VG-T425M..	50550b		
VG-BPT..	54030b	VG-NG91..	51720a	VG-TP..	54030a		
VG-BPV..	54030b	VG-P1040M..	50560a	VG-U3041..	50550a		
VG-BWS-125-10	50570a	VG-P105..	50650a	VG-U3042..	50550a		
VG-DB83M-B-10	51710a	VG-P10MRD..	51710a	VG-U3043..	50550a		
VG-F203M..	50550b	VG-P12MRD..	51710a	VG-U4045..	50550a		
VG-F205M..	50550b	VG-P14BC..	50650a	VG-J23..	50520a		
VG-F205M..	51120a	VG-P14HD..	50650b	VG-Z18M..	50520a		
VG-F206M..	51120a	VG-P18BC..	50650a	VG-Z20M..	50520a		
VG-F253M..	50550b	VG-P18CC-100	50530a	VG-Z20WM..	50520a		
VG-F303M..	50550b	VG-P18HD..	50650b	VG-Z21..	50520a		
VG-F403..	50550a	VG-P2520..	51740b	VT1701T..	50170a		
VG-F403M..	50550b	VG-P316BC..	50650a	VT1710CT..	50170a		
VG-F503M..	50550b	VG-P316HD..	50650b	VT1713CT..	50180a		
VG-F603M..	50550b	VG-P330C..	50580a	VT1873T..	50160a		
VG-F703M..	50550b	VG-P330CW..	50610a	VT880B..	50130a		
VG-G1020M..	51660b	VG-P330M..	50560a	VT880T..	50110a		
VG-GD..	51660a	VG-P516BC..	50650b	VT882..	50140a		
VG-H7816M..	51690a	VG-P640M..	50560a	VT882B..	50150a		
VG-H14022M..	51703a	VG-P650M..	50560a	VTC880..	50120a		
VG-H8716M..	51700a	VG-P680M..	50560a	VTR880B..	50130a		
VG-H9014M..	51680a	VG-P7GABC..	50650a	VTR882B..	50150a		
VG-J100-125T..	50530a	VG-P7GAHD..	50650b	W1700	11530a		
VG-J100-188..	50530b	VG-P813..	51740a				
VG-J21M..	50520a	VG-P816..	51740a				
VG-J23M..	50520a	VG-P822..	51740a				
VG-JEL-078..	50530a	VG-P834..	51740a				
VG-JL19M..	50520a	VG-P840DBM..	51710a				
VG-JS100-125..	50530a	VG-P840M..	50560a				
VG-JS100-188..	50530b	VG-P8MRD..	51710a				
VG-JS150-125..	50530a	VG-PBG5..	51730a				
VG-JS150-18..	50530b	VG-PBG7..	51730a				
VG-JS200-125..	50530a	VG-PD..	51660b				
VG-JS200-188..	50530b	VG-PM10BC..	50650b				
VG-JS3-075-125..	50530a	VG-PM4BC..	50650a				

Legend

Codes ending with .. indicate a group of item descriptions all starting with the code listed. Example: 2122.. (all item descriptions starting with 2122).
 Codes with .. in the middle indicate a group of item descriptions starting and ending with the codes listed. Example 2251..RS (all item descriptions starting with 2251 and ending with RS). **Information about item descriptions, printed in blue, is only available on our website: www.SystemPlastSmartGuide.com**