

Chains & sprockets	Wear strips	Side guide brackets & accessories	Levelers	Engineering manual
Modular belts & sprockets	Chain & belt return systems	Frame & structure supports	Bearing supports	
Curves & tracks	Side guide solutions	Miscellaneous products	Equipment	

SYSTEM PLAST®

Smart Guide

1 0 1 1 0 a

GENERAL INDEX

www.SystemPlastSmartGuide.com

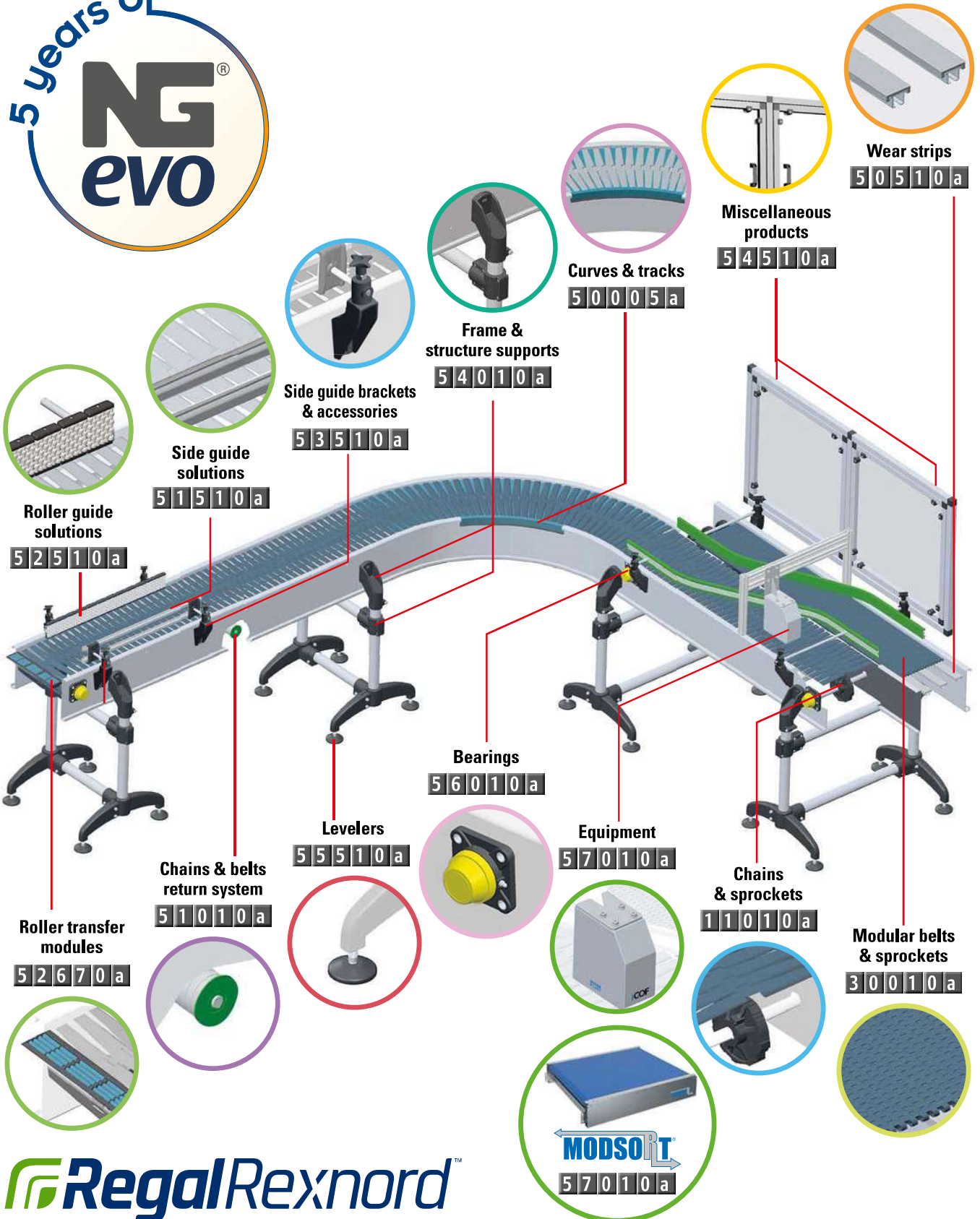











RegalRexnord™















Chains & sprockets	Wear strips	Side guide brackets & accessories	Levelers	Engineering manual
Modular belts & sprockets	Chain & belt return systems	Frame & structure supports	Bearing supports	
Curves & tracks	Side guide solutions	Miscellaneous products	Equipment	

1 0 1 1 0 d

LEGEND ICONS

www.SystemPlastSmartGuide.com

ICON	LEGEND
	Link to open menu for technical information related to the products listed on this page.
1 1 0 1 1 a	Link to find related products.
	Link to find related products. Note: only available on our website www.SystemPlastSmartGuide.com
3 0 7 2 0 a	Codes in orange background are indicators for modular belts in molded to width versions.
	Information only available on our website: www.SystemPlastSmartGuide.com
	Link to other varieties of these chains and/or link to the chains used with the sprockets listed on this page.
	Link to other varieties of these modular belts and/or link to the belts used with the sprockets listed on this page.
	Link to the sprockets used with the chains or belts listed on this page.
MOQ	Minimum order quantity.
	Indicates chains, belts or curves suitable for magnetic curve systems.
	This product includes patented features.
	Link to general information about the products listed on this page.
	This product is not suitable in use with chains with hold-down tabs.

ICON	LEGEND
	Weight in Kg/m
	Length per standard code.
	Length per standard coil.
	Quantity standard packaging.
	Indication for products that contain a dry lubricant.
	Material: stainless steel AISI 430.
	Material: stainless steel AISI 304.
	Material: aluminum, anodized.
	Material: aluminum.
	Material: zinc plated steel.
	Nominal diameter 41mm.
	Product suitable for assembly to a rectangular profile.
	Max load capacity.
	Wrench size.

Chains & sprockets	Wear strips	Side guide brackets & accessories	Levelers	Engineering manual
Modular belts & sprockets	Chain & belt return systems	Frame & structure supports	Bearing supports	
Curves & tracks	Side guide solutions	Miscellaneous products	Equipment	

3 0 0 1 0 a

www.SystemPlastSmartGuide.com

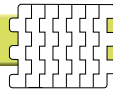

INDEX MODULAR BELTS STRAIGHT RUNNING

FROM 8 mm (1/3") TO 25,4 mm (1") PITCH

Pitch

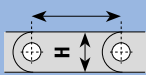

For other types of belt go to:

3 0 0 1 1 a Index modular belt straight running
pitch 25,4 mm (1"), 50,8 mm (2") and 63,5 mm (2 1/2")

3 0 0 1 2 a Index modular belt sideflexing

Information about this product is only available on our Smart Guide® website.



PITCH mm	H mm	VERSION MODULE	BELT SERIES	FLAT TOP	FLUSH GRID	RUBBER INSERTS	LBP	SPECIAL
8 (1/3")	6	Imperial	2080	New	-	-	-	-
		3 0 0 2 7 a	3 0 0 2 5 a					
12,7 (1/2")	8,7	Metric 85	2120					Guide bar
		3 0 1 6 0 a	3 0 0 5 0 a	3 0 0 7 0 a	3 0 1 0 0 a	3 0 1 1 0 a	3 0 1 2 0 a	
		Metric 100	2122	-		-	-	-
		3 0 1 6 6 a	3 0 0 7 3 a					
		Imperial	2121		-	-	-	-
		3 0 1 6 0 a	3 0 0 5 5 a	3 0 0 3 0 a				
		Metric	2124		-		-	-
3 0 1 6 5 a	3 0 0 3 0 a	3 0 0 9 0 a						
19,05 (3/4")	8,7	Imperial	2190			-	-	-
		3 0 2 3 5 a	3 0 2 1 0 a	3 0 2 3 0 a	3 0 2 2 0 a			
25,4 (1")	8,7	Metric	2250				-	Flights
		3 0 3 9 5 a	3 0 3 2 5 a	3 0 3 6 0 a	3 0 3 4 0 a	3 0 3 7 0 a	3 0 3 6 5 a	
		Imperial	2253		-	-	-	Roller top New
		3 0 3 9 5 a	3 0 3 3 0 a	3 0 3 9 8 a				



Indication for molded to width versions

Chains & sprockets	Wear strips	Side guide brackets & accessories	Levelers	Engineering manual
Modular belts & sprockets	Chain & belt return systems	Frame & structure supports	Bearing supports	
Curves & tracks	Side guide solutions	Miscellaneous products	Equipment	

3 0 0 1 1 a

www.SystemPlastSmartGuide.com

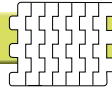

INDEX MODULAR BELTS STRAIGHT RUNNING



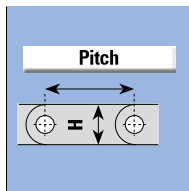







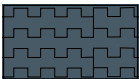
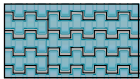
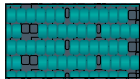







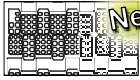

FROM 25,4 mm (1") TO 63,5 mm (2 1/2") PITCH

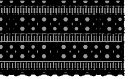

For other types of belt go to:

3 0 0 1 0 a Index modular belt straight running
pitch 8 mm (1/3") to 25,4 mm (1")

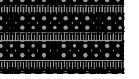
3 0 0 1 2 a Index modular belt sideflexing

PITCH mm	H mm	VERSION MODULE	BELT SERIES	FLAT TOP	FLUSH GRID	RUBBER INSERTS	LBP	SPECIAL	
25,4 (1")	12,7	Metric	2251	 3 0 4 4 0 a 3 0 4 2 0 a	-	 3 0 4 9 0 a	 3 0 5 0 0 a	-	
				 3 0 5 5 0 a  3 0 4 2 0 a 					
		Imperial	2252	 3 0 4 4 5 a 3 0 4 2 0 a 	 3 0 4 8 1 a 	-	-	-	-
				 3 0 5 5 0 a 					
50,8 (2")	12,7	Metric	2502	-	-	-	-	Draining Top  3 0 6 1 7 a 	
				 3 0 6 1 8 a 					
	16	Imperial	2500	-	-	-	-	Raised rib  3 0 6 1 0 a	
				 3 0 6 1 5 a 					
	22	Metric	2508	Anti-slip surface  3 0 6 2 0 a	-	-	-	-	
				 3 0 6 4 0 a 					
63,5 (2 1/2")	30	Metric	2630	Anti-slip surface  3 0 6 4 5 a	-	-	-	-	
				 3 0 6 5 0 a 					



Indication for molded to width versions

Chains & sprockets	Wear strips	Side guide brackets & accessories	Levelers	Engineering manual
Modular belts & sprockets	Chain & belt return systems	Frame & structure supports	Bearing supports	
Curves & tracks	Side guide solutions	Miscellaneous products	Equipment	

3 0 0 1 2 a

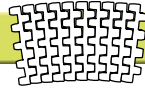

INDEX SIDEFLEXING MODULAR BELT

www.SystemPlastSmartGuide.com

Pitch		For other types of belt go to:						
PITCH mm	H mm	VERSION MODULE	BELT SERIES	FLAT TOP	FLUSH GRID	RUBBER INSERTS	LBP	SPECIAL
12,7 (½")	8,7	Metric	2120	New	-	-	-	-
		3 0 1 6 0 a	3 0 7 2 0 a					
25,4 (1")	8,7	TAB chainbelt	2250 TAB		-	-	-	-
		3 0 7 1 5 a	3 0 7 1 0 a					
		Magnetic chainbelt	2260		New	-	-	-
		3 0 7 1 5 a	3 0 7 0 0 a	3 0 7 0 0 a				
25,4 (1")	12,7	Magnetic chainbelt	2251		-	-	-	-
		3 0 7 1 5 a	3 0 7 0 0 a					
		TAB chainbelt	2251 TAB		-	-	-	-
		3 0 7 1 5 a	3 0 7 1 0 a					
25,4 (1")	12,7	Imperial	2256	-			-	-
		3 0 7 4 0 a	3 0 7 3 0 a	3 0 7 3 5 a				
31,75 (1¼")	12,7	Metric	2351 2451 2551 2651	-			-	-
		3 0 7 6 0 a	3 0 7 4 5 a	3 0 7 5 5 a				



Indication for molded to width versions

Chains & sprockets	Wear strips	Side guide brackets & accessories	Levelers	Engineering manual
Modular belts & sprockets	Chain & belt return systems	Frame & structure supports	Bearing supports	
Curves & tracks	Side guide solutions	Miscellaneous products	Equipment	

3 0 0 2 0 a

INDEX MODULAR BELTS

www.SystemPlastSmartGuide.com

12,7 mm (1/2") - THICKNESS: 8,7 mm (0.34 in)

FLAT TOP VERSION

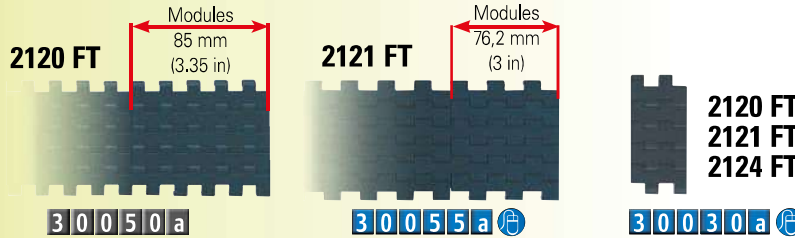

FLAT TOP VERSION WITH TRANSFER WING



FLUSH GRID VERSION

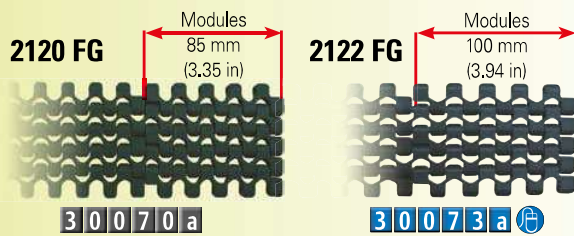

VERSIONS WITH RUBBER INSERTS

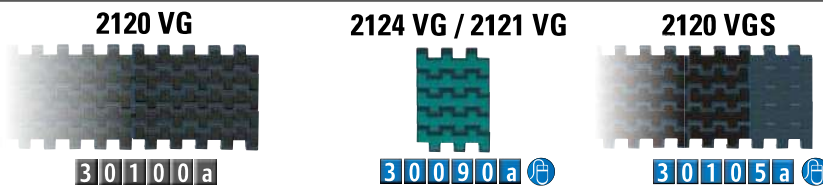

VERSION WITH ACCUMULATION ROLLERS



VERSION WITH GUIDE BARS FOR TRANSFERS



VERSION SIDEFLEXING FOR MAGNETIC CURVES

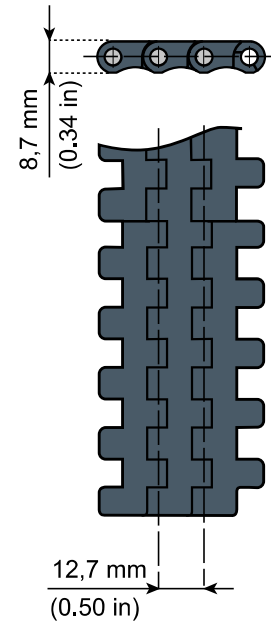

Usually used on short conveyors with a Nose Bar to create extremely short transfers

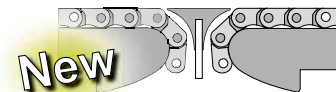

page code: **3 0 1 7 5 a**



Information about this product is only available on our Smart Guide® website.



Chains & sprockets	Wear strips	Side guide brackets & accessories	Levelers	Engineering manual
Modular belts & sprockets	Chain & belt return systems	Frame & structure supports	Bearing supports	
Curves & tracks	Side guide solutions	Miscellaneous products	Equipment	

SYSTEM PLAST®



3 0 0 2 5 a

www.SystemPlastSmartGuide.com

8 mm (1/3") MODULAR BELTS 2080 - MICROPITCH

FLAT TOP VERSION

New

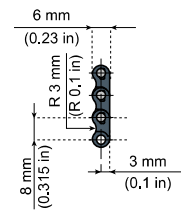
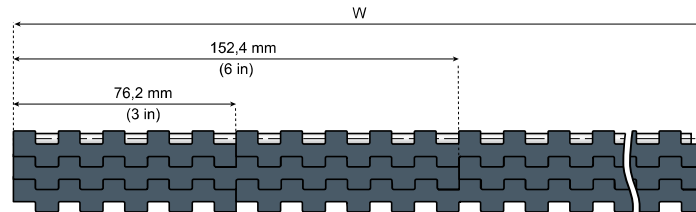

NG® evo conveyor components made from engineered plastic resin

- Longer wearlife than acetal
- Lower friction than acetal
- Good chemical resistance
- High abrasion resistance
- It meets the requirement for materials as stated by EC1935/2004 and FDA CFR21 norms for direct food contact
- Less dust than with acetal chains
- More.....

- Backflex radius:** 10 mm (0,39 in)
- Max load capacity:** 12500 N/m (850 lbs/ft.)
- Weight:** 5,5 Kg/m² (1,12 lbs/ft².)
- Pin material:** PBT (white)
- Standard length:**
 - width ≤ 15 in: 3,040m (380 rows)
 - width > 15 in ≤ 66 in: 1,520m (190 rows)
 - width > 66 in: on request



Usually used on short conveyors with a Nose Bar to create extremely short transfers

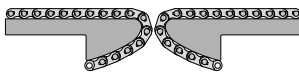

page code: **3 0 0 2 9 a**



Information about this product is only available on our Smart Guide® website.

Standard materials

NGE (GREY BLUE)

New Generation®

LFB (BLUE)

Low friction acetal resin

materials details: **7 3 5 6 3 a**

Also available into

POM-AS (BLACK)

Anti-static acetal

materials details: **7 2 3 3 6 a**

WIDTH W		ITEM DESCRIPTION	
mm	in	NGE (GREY BLUE)	LFB (BLUE)
76	3,00	NGE2080FT-K300	LFB2080FT-K300
152	6,00	NGE2080FT-K600	LFB2080FT-K600
229	9,00	NGE2080FT-K900	LFB2080FT-K900
305	12,00	NGE2080FT-K1200	LFB2080FT-K1200
381	15,00	NGE2080FT-K1500	LFB2080FT-K1500
457	18,00	NGE2080FT-K1800	LFB2080FT-K1800
533	21,00	NGE2080FT-K2100	LFB2080FT-K2100
610	24,00	NGE2080FT-K2400	LFB2080FT-K2400
686	27,00	NGE2080FT-K2700	LFB2080FT-K2700
762	30,00	NGE2080FT-K3000	LFB2080FT-K3000
838	33,00	NGE2080FT-K3300	LFB2080FT-K3300
914	36,00	NGE2080FT-K3600	LFB2080FT-K3600
991	39,00	NGE2080FT-K3900	LFB2080FT-K3900
1067	42,00	NGE2080FT-K4200	LFB2080FT-K4200
1143	45,00	NGE2080FT-K4500	LFB2080FT-K4500
1219	48,00	NGE2080FT-K4800	LFB2080FT-K4800
1295	51,00	NGE2080FT-K5100	LFB2080FT-K5100
1372	54,00	NGE2080FT-K5400	LFB2080FT-K5400
1448	57,00	NGE2080FT-K5700	LFB2080FT-K5700
1524	60,00	NGE2080FT-K6000	LFB2080FT-K6000
1600	63,00	NGE2080FT-K6300	LFB2080FT-K6300
1676	66,00	NGE2080FT-K6600	LFB2080FT-K6600
1753	69,00	NGE2080FT-K6900	LFB2080FT-K6900
1829	72,00	NGE2080FT-K7200	LFB2080FT-K7200
1905	75,00	NGE2080FT-K7500	LFB2080FT-K7500
1981	78,00	NGE2080FT-K7800	LFB2080FT-K7800
2057	81,00	NGE2080FT-K8100	LFB2080FT-K8100
2134	84,00	NGE2080FT-K8400	LFB2080FT-K8400

Other widths available on request.

Chains & sprockets	Wear strips	Side guide brackets & accessories	Levelers	Engineering manual
Modular belts & sprockets	Chain & belt return systems	Frame & structure supports	Bearing supports	
Curves & tracks	Side guide solutions	Miscellaneous products	Equipment	

3 0 0 2 7 a

www.SystemPlastSmartGuide.com

DRIVE SPROCKETS

FOR BELT 2080



Features:

- Split versions: quick and easy replacement.
- Foolproof design.
- Completely closed structure, easy to clean and to disinfect.
- Excellent wear and chemical resistance.
- Recyclable.



See 8 mm (1/3") pitch belts:

3 0 0 2 5 a

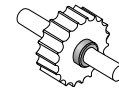

Set collars, go to:

5 4 6 3 0 a

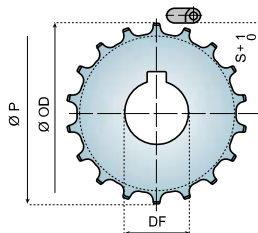

	MACHINED DRIVE SPROCKETS - ONE PIECE TIGHT		
Z	Ø 30		
	ITEM DESCRIPTION		
24	2080-24R30M-DM		

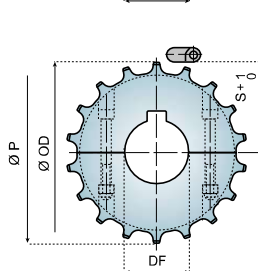

	MACHINED DRIVE SPROCKETS - SPLIT FIXED		
Z	Ø 20	Ø 25	Ø 30
	ITEM DESCRIPTION		
24	2080-24R20M-DMS	2080-24R25M-DMS	-
32	-	2080-32R25M-DMS	2080-32R30M-DMS
36	-	2080-36R25M-DMS	2080-36R30M-DMS

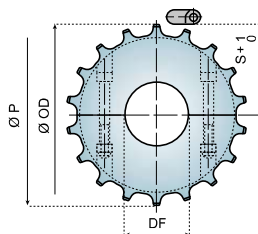

	MACHINED RETURN SPROCKETS - SPLIT		
36	-	2080-36R25M-RMS	2080-36R30M-RMS

Material: polyamide (natural white), screws in stainless steel, nuts in zinc plated steel.

Z	Ø OD mm	Ø P mm	S mm
24	60,6	61,3	28
32	81,0	81,6	38
36	90,4	91,8	43,5

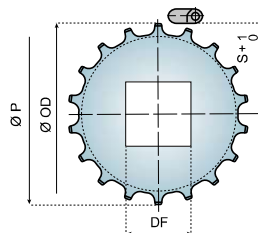

	MACHINED DRIVE SPROCKETS SQUARE BORE - ONE PIECE FLOATING		
Z	30X30		
	ITEM DESCRIPTION		
24	2080-24S30M-DM		

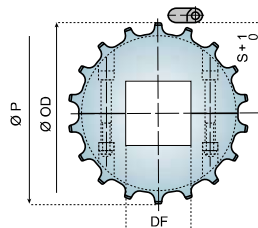

	MACHINED DRIVE SPROCKETS SQUARE BORE - SPLIT FLOATING		
Z	25X25	30X30	40X40
	ITEM DESCRIPTION		
32	2080-32S25M-DMS	2080-32S30M-DMS	-
36	-	2080-36S30M-DMS	2080-36S40M-DMS

Material: polyamide (natural white), screws in stainless steel, nuts in zinc plated steel.

Chains & sprockets	Wear strips	Side guide brackets & accessories	Levelers	Engineering manual
Modular belts & sprockets	Chain & belt return systems	Frame & structure supports	Bearing supports	
Curves & tracks	Side guide solutions	Miscellaneous products	Equipment	



3 0 0 2 9 a

NOSE BAR FOR 2080 BELTS (1/3" - 8 mm PITCH)

www.SystemPlastSmartGuide.com

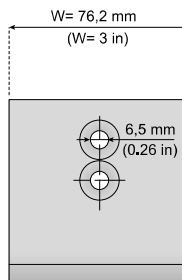
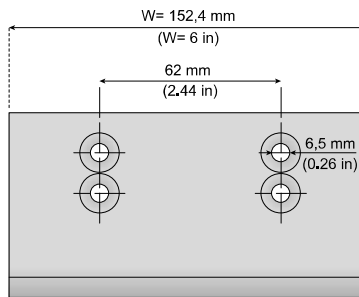
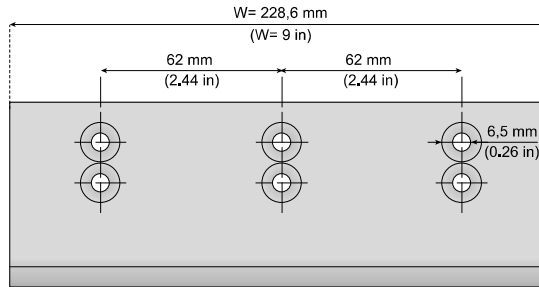
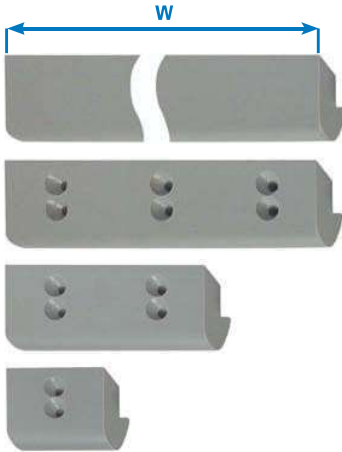

Usually used on short conveyors with a Nose Bar to create extremely short transfers

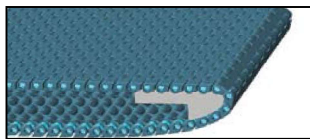
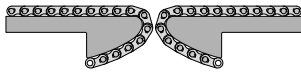

Sagline angle

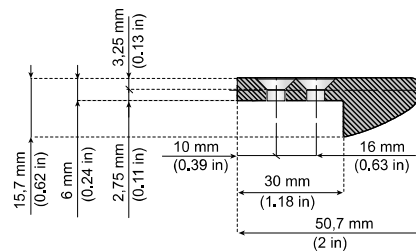
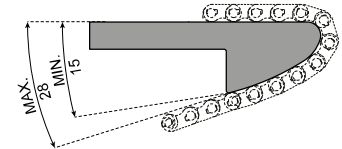

See straight running belts with 1/3" - 8 mm pitch:

3 0 0 2 5 a

New

PATENTED

SILENT NOSE BAR

ITEM DESCRIPTION	W mm	W in
SNB2080-NS-76H	76,2	3
SNB2080-NS-152H	152,4	6
SNB2080-NS-228H	228,6	9
SNB2080-NS-1200	1200	47,2

Note:

1,2 m nose bar is supplied WITHOUT holes

Chains & sprockets	Wear strips	Side guide brackets & accessories	Levelers	Engineering manual
Modular belts & sprockets	Chain & belt return systems	Frame & structure supports	Bearing supports	
Curves & tracks	Side guide solutions	Miscellaneous products	Equipment	

30030a

12,7 mm (1/2") MODULAR BELTS

www.SystemPlastSmartGuide.com

SINGLE TRACK FLAT TOP

New
NG evo

NG® evo conveyor components made from engineered plastic resin
 Longer wearlife than acetal
 Lower friction than acetal
 Good chemical resistance
 High abrasion resistance
 It meets the requirement for materials as stated by EC1935/2004 and FDA CFR21 norms for direct food contact
 Less dust than with acetal chains
 More.....

2124 versions: 34 mm (1.34 in) wide

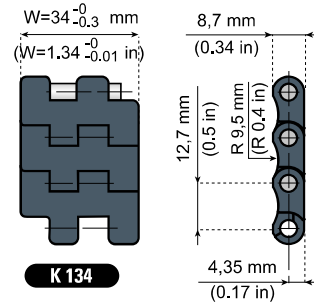

K 134

Pin material: PBT (white)

ITEM DESCRIPTION	MATERIAL	WIDTH W		BACKFLEX RADIUS		MAX LOAD CAPACITY		WEIGHT	
		mm	in	mm	in	N	lbs	Kg/m	lbs/ft.
NGE2124FT-K134	NGE Grey Blue	34	1,34	10	0,39	300	65	0,3	0,2

Standard length: 240 pitches (3,048 m - 10 ft.)



30165a

Information about this product is only available on our Smart Guide® website.

2120/2121 versions: 51-190,5 mm (2 - 7.5 in) wide

New
NG evo

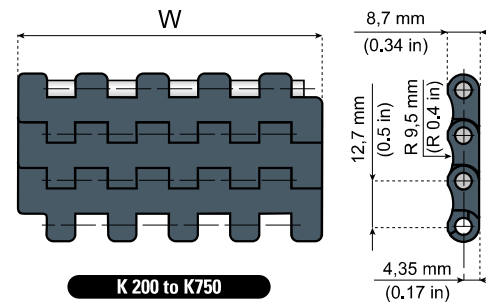

K 200 to K750

Pin material: PBT (white)

ITEM DESCRIPTION	MATERIAL	WIDTH W		BACKFLEX RADIUS		MAX LOAD CAPACITY		WEIGHT	
		mm	in	mm	in	N	lbs	Kg/m	lbs/ft.
NGE2121FT-K200	NGE Grey Blue	51	2	10	0.39	680	150	0,45	0,30
NGE2121FT-K300		76,2	3			1370	300	0,7	0,47
NGE2121FT-K325		82,6	3.25			1490	330	0,7	0,47
NGE2120FT-K330		83,8	3.3			1490	330	0,7	0,47
NGE2121FT-K450		114,3	4.5			2060	460	1	0,67
NGE2121FT-K600		152,4	6			2750	610	1,3	0,87
NGE2121FT-K750		190,5	7,50			3430	760	1,7	1,14

Standard length: 240 pitches (3,048 m - 10 ft.)



30160a

Notes:
Schematic presentation of all flat top 12,7 mm (1/2") pitch belts

Other versions for 12,7 mm (1/2") belts:

- FG Flush grid**
- VG Rubber insert**
- LBP (low pressure)**
- GB (Guide bar)**
- Sideflex**



Information about this product is only available on our Smart Guide® website.

Standard material
NGE (GREY BLUE)
 New Generation®

materials details:

73563a

Usually used on short conveyors with a Nose Bar to create extremely short transfers

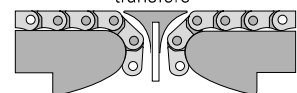

page code: 30175a

Chains & sprockets	Wear strips	Side guide brackets & accessories	Levelers	Engineering manual
Modular belts & sprockets	Chain & belt return systems	Frame & structure supports	Bearing supports	
Curves & tracks	Side guide solutions	Miscellaneous products	Equipment	

30030b

www.SystemPlastSmartGuide.com

12,7 mm (1/2") MODULAR BELTS

SINGLE TRACK FLAT TOP WITH POSITIONERS

2124 versions: 34 mm (1.34 in) wide

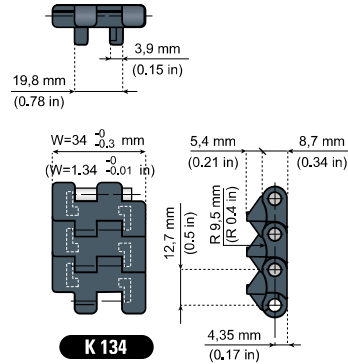

NGE® evo conveyor components made from engineered plastic resin

- Longer wearlife than acetal
- Lower friction than acetal
- Good chemical resistance
- High abrasion resistance
- It meets the requirement for materials as stated by EC1935/2004 and FDA CFR21 norms for direct food contact
- Less dust than with acetal chains
- More.....

K 134

Pin material: PBT (white)



ITEM DESCRIPTION	MATERIAL	WIDTH W		BACKFLEX RADIUS		MAX LOAD CAPACITY		WEIGHT	
		mm	in	mm	in	N	lbs	Kg/m	lbs/ft.
NGE2124FT-PT-K134	NGE Grey Blue	34	1,34	10	0,39	300	65	0,3	0,2

30165a

Information about this product is only available on our Smart Guide® website.

Standard length: 240 pitches (3,048 m - 10 ft.)

2120/2121 versions: 51-190,5 mm (2 & 7.5 in) wide

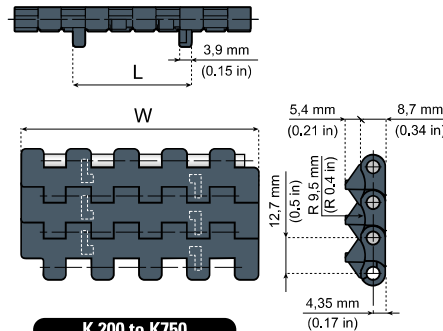

K 200 to K750

Pin material: PBT (white)



ITEM DESCRIPTION	MATERIAL	L		WIDTH W		BACKFLEX RADIUS		MAX LOAD CAPACITY		WEIGHT	
		mm	in	mm	in	mm	in	N	lbs	Kg/m	lbs/ft.
NGE2121FT-PT-K200	NGE Grey Blue	35,8	1,41	51	2	10	0,39	680	150	0,45	0,3
NGE2121FT-PT-K300		43,1	1,7	76,2	3			1370	300	0,7	0,47
NGE2121FT-PT-K325		43,1	1,7	82,6	3,25			1490	330	0,7	0,47
NGE2120FT-PT-K330		42,1	1,66	83,8	3,3			1490	330	0,7	0,47
NGE2121FT-PT-K450		43,1	1,7	114,3	4,5			2060	460	1	0,67
NGE2121FT-PT-K600		43,1	1,7	152,4	6			2750	610	1,3	0,87
NGE2121FT-PT-K750		43,1	1,7	190,5	7,5			3430	760	1,7	1,14

30160a

Standard length: 240 pitches (3,048 m - 10 ft.)

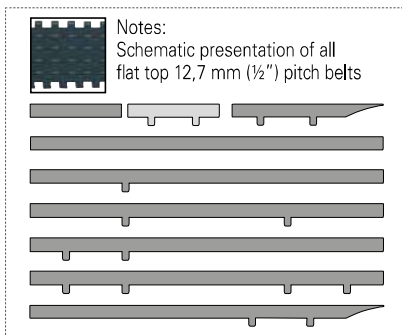

Other versions for 12,7 mm (1/2") belts:

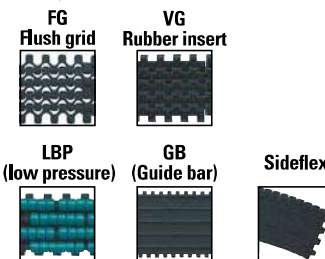

Standard material

NGE (GREY BLUE)

New Generation®

materials details:

73563a



Information about this product is only available on our Smart Guide® website.

Chains & sprockets	Wear strips	Side guide brackets & accessories	Levelers	Engineering manual
Modular belts & sprockets	Chain & belt return systems	Frame & structure supports	Bearing supports	
Curves & tracks	Side guide solutions	Miscellaneous products	Equipment	

30045a

12,7 mm (1/2") 2120 WITH TRANSFER WING

www.SystemPlastSmartGuide.com

Single track

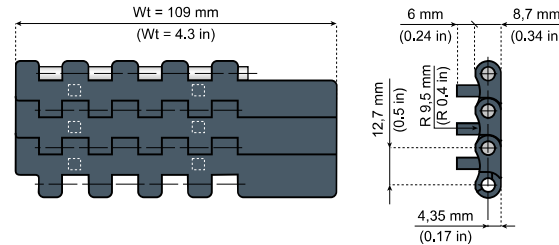
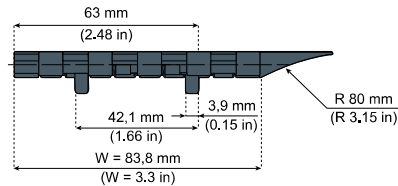
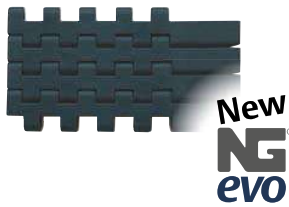

NGE® evo conveyor components made from engineered plastic resin

Longer wearlife than acetal
Lower friction than acetal
Good chemical resistance
High abrasion resistance
It meets the requirement for materials as stated by EC1935/2004 and FDA CFR21 norms for direct food contact
Less dust than with acetal chains
More.....

Pin material: PBT (white)

ITEM DESCRIPTION	MATERIAL	WIDTH W		PITCH P		BACKFLEX RADIUS		MAX LOAD CAPACITY		WEIGHT	
		mm	in	mm	in	mm	in	N	lbs	Kg/m	lbs/ft.
NGE2120FT-PT-K330T	NGE Grey Blue	83,8	3,3	12,7	0,5	15	0,59	1490	330	0,9	0,6

Standard length: 240 pitches (3,048 m - 10 ft.)

Wider versions

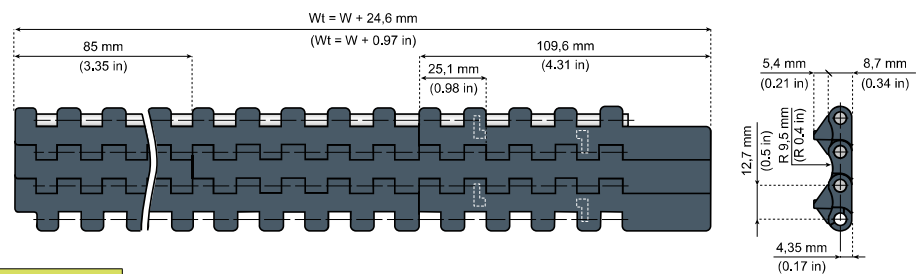

WIDTH W		ITEM DESCRIPTION
mm	in	
85	3,35	NGE2120FT-PT-M0085T
170	6,69	NGE2120FT-PT-M0170T
255	10,04	NGE2120FT-PT-M0255T
340	13,39	NGE2120FT-PT-M0340T
425	16,73	NGE2120FT-PT-M0425T
510	20,08	NGE2120FT-PT-M0510T

Backflex radius: 15 mm (0.59 in)
Max load capacity: 18000 N/m (1260 lbs/ft.)
Weight: 8,6 Kg/m² (1.75 lbs/ft.²)
Pin material: PBT (white)
Standard length:
width ≤ 340 mm (13,39 in): 3,048 m (10 ft.)
width > 340 mm (13,39 in): 1,524 m (5 ft.)

Other widths available on request.

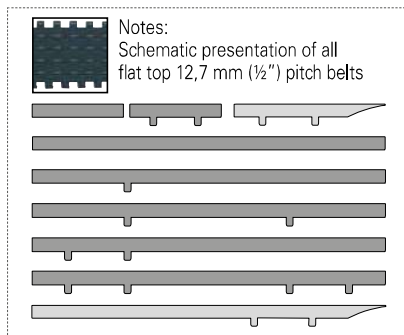

Other versions for 12,7 mm (1/2") belts:

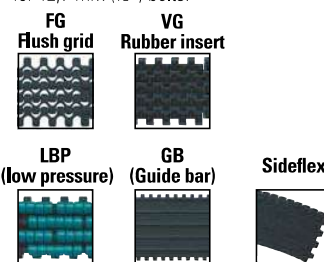

Standard material
NGE (GREY BLUE)

New Generation®

materials details:



Information about this product is only available on our Smart Guide® website.

Chains & sprockets	Wear strips	Side guide brackets & accessories	Levelers	Engineering manual
Modular belts & sprockets	Chain & belt return systems	Frame & structure supports	Bearing supports	
Curves & tracks	Side guide solutions	Miscellaneous products	Equipment	

SYSTEM PLAST®



30050a

12,7 mm (½") MODULAR BELTS 2120

www.SystemPlastSmartGuide.com

FLAT TOP VERSION

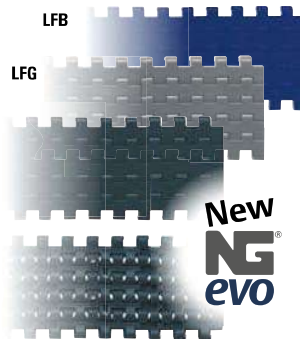

NG® evo conveyor components
made from engineered plastic resin

- Longer wearlife than acetal
- Lower friction than acetal
- Good chemical resistance
- High abrasion resistance
- It meets the requirement for materials as stated by EC1935/2004 and FDA CFR21 norms for direct food contact
- Less dust than with acetal chains
- More.....

Backflex radius: 10 mm (0,39 in)
Max load capacity (LFG & LFB): 20000 N/m (1400 lbs/ft.)
Weight: 8,6 Kg/m² (1,75 lbs/ft.²)
Pin material: PBT (white)
Standard length:

width ≤ 340 mm (13,39 in): 3,048 m (10 ft.)
width > 340 mm (13,39 in) ≤ 1700 mm (66,93 in): 1,524 m (5 ft.)
width > 1700 mm (66,93 in): on request

Usually used on short conveyors with a Nose Bar to create extremely short transfers

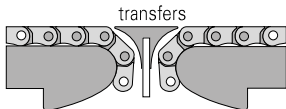

page code: **30175a**

Notes:
Schematic presentation of all flat top 12,7 mm (½") pitch belts



Other versions for 12,7 mm (½") belts:

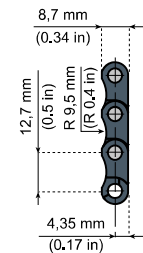
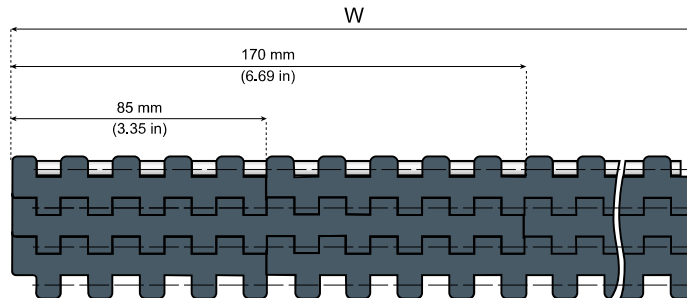
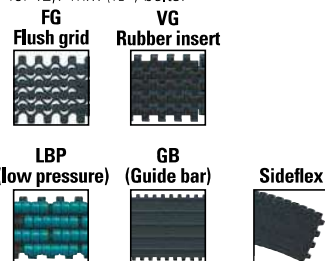

Standard materials

NGE (GREY BLUE)	LFG (GREY)	LFB (BLUE)
New Generation®	Low friction acetal resin	

materials details:

73563a ⓘ

30160a ⓘ



Information about this product is only available on our Smart Guide® website.

Also available with 3 in (76,2 mm) modules. Go to: **30055a** ⓘ

WIDTH W		ITEM DESCRIPTION		
mm	in	NGE (GREY BLUE)	LFG (GREY)	LFB (BLUE)
85	3,35	NGE2120FT-M0085	LFG2120FT-M0085	LFB2120FT-M0085
170	6,69	NGE2120FT-M0170	LFG2120FT-M0170	LFB2120FT-M0170
255	10,04	NGE2120FT-M0255	LFG2120FT-M0255	LFB2120FT-M0255
340	13,39	NGE2120FT-M0340	LFG2120FT-M0340	LFB2120FT-M0340
425	16,73	NGE2120FT-M0425	LFG2120FT-M0425	LFB2120FT-M0425
510	20,08	NGE2120FT-M0510	LFG2120FT-M0510	LFB2120FT-M0510
595	23,43	NGE2120FT-M0595	LFG2120FT-M0595	LFB2120FT-M0595
680	26,77	NGE2120FT-M0680	LFG2120FT-M0680	LFB2120FT-M0680
765	30,12	NGE2120FT-M0765	LFG2120FT-M0765	LFB2120FT-M0765
850	33,46	NGE2120FT-M0850	LFG2120FT-M0850	LFB2120FT-M0850
935	36,81	NGE2120FT-M0935	LFG2120FT-M0935	LFB2120FT-M0935
1020	40,16	NGE2120FT-M1020	LFG2120FT-M1020	LFB2120FT-M1020
1105	43,50	NGE2120FT-M1105	LFG2120FT-M1105	LFB2120FT-M1105
1190	46,85	NGE2120FT-M1190	LFG2120FT-M1190	LFB2120FT-M1190
1275	50,20	NGE2120FT-M1275	LFG2120FT-M1275	LFB2120FT-M1275
1360	53,54	NGE2120FT-M1360	LFG2120FT-M1360	LFB2120FT-M1360
1445	56,89	NGE2120FT-M1445	LFG2120FT-M1445	LFB2120FT-M1445
1530	60,24	NGE2120FT-M1530	LFG2120FT-M1530	LFB2120FT-M1530
1615	63,58	NGE2120FT-M1615	LFG2120FT-M1615	LFB2120FT-M1615
1700	66,93	NGE2120FT-M1700	LFG2120FT-M1700	LFB2120FT-M1700
1785	70,28	NGE2120FT-M1785	LFG2120FT-M1785	LFB2120FT-M1785
1870	73,62	NGE2120FT-M1870	LFG2120FT-M1870	LFB2120FT-M1870
1955	76,97	NGE2120FT-M1955	LFG2120FT-M1955	LFB2120FT-M1955
2040	80,31	NGE2120FT-M2040	LFG2120FT-M2040	LFB2120FT-M2040
2125	83,66	NGE2120FT-M2125	LFG2120FT-M2125	LFB2120FT-M2125
2210	87,01	NGE2120FT-M2210	LFG2120FT-M2210	LFB2120FT-M2210
2295	90,35	NGE2120FT-M2295	LFG2120FT-M2295	LFB2120FT-M2295

Other widths available on request.

Chains & sprockets	Wear strips	Side guide brackets & accessories	Levelers	Engineering manual
Modular belts & sprockets	Chain & belt return systems	Frame & structure supports	Bearing supports	
Curves & tracks	Side guide solutions	Miscellaneous products	Equipment	

SYSTEM PLAST®



3 0 0 5 5 a

www.SystemPlastSmartGuide.com

12,7 mm (½") MODULAR BELTS 2121

FLAT TOP VERSION - 76,2 mm (3") MODULES



New NG evo

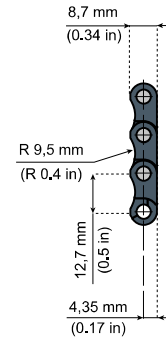
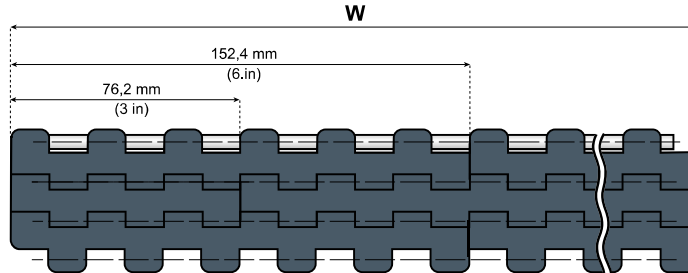

NG® evo conveyor components
made from **engineered plastic resin**

- Longer wear life than acetal
- Lower friction than acetal
- Good chemical resistance
- High abrasion resistance
- It meets the requirement for materials as stated by EC1935/2004 and FDA CFR21 norms for direct food contact
- Less dust than with acetal chains
- More.....

Backflex radius: 10 mm (0,4 in)

Max load capacity: 18000 N/m (1260 lbs/ft.)

Weight: 8,8 Kg/m² (1.8 lbs/ft.²)

Pin material: POM (grey)

Standard length:

width ≤ 15 in: 3,048 m (10 ft.)

width > 15 in ≤ 66 in: 1,524 m (5 ft.)

width > 66 in: on request

Usually used on short conveyors with a Nose Bar to create extremely short transfers

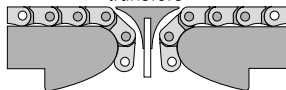

page code: **3 0 1 7 5 a**



Notes:
Schematic presentation of all flat top 12,7 mm (½") pitch belts

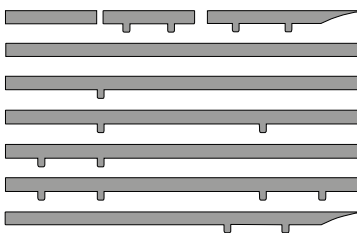

Other versions for 12,7 mm (½") belts:

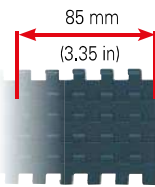

Also available with 85 mm (3.35 in) modules. Go to:

3 0 0 5 0 a



Information about this product is only available on our Smart Guide® website.

Standard material

NGE (GREY BLUE)

New Generation®

materials details:

7 3 5 6 3 a

WIDTH W		ITEM DESCRIPTION
mm	in	
76	3.00	Go to: 3 0 0 3 0 a
152	6.00	
229	9.00	NGE2121FT-K900
305	12.00	NGE2121FT-K1200
381	15.00	NGE2121FT-K1500
457	18.00	NGE2121FT-K1800
533	21.00	NGE2121FT-K2100
610	24.00	NGE2121FT-K2400
686	27.00	NGE2121FT-K2700
762	30.00	NGE2121FT-K3000
838	33.00	NGE2121FT-K3300
914	36.00	NGE2121FT-K3600
991	39.00	NGE2121FT-K3900
1067	42.00	NGE2121FT-K4200
1143	45.00	NGE2121FT-K4500
1219	48.00	NGE2121FT-K4800
1295	51.00	NGE2121FT-K5100
1372	54.00	NGE2121FT-K5400
1448	57.00	NGE2121FT-K5700
1524	60.00	NGE2121FT-K6000
1600	63.00	NGE2121FT-K6300
1676	66.00	NGE2121FT-K6600
1753	69.00	NGE2121FT-K6900
1829	72.00	NGE2121FT-K7200
1905	75.00	NGE2121FT-K7500
1981	78.00	NGE2121FT-K7800
2057	81.00	NGE2121FT-K8100
2134	84.00	NGE2121FT-K8400

Other widths available on request.

Chains & sprockets	Wear strips	Side guide brackets & accessories	Levelers	Engineering manual
Modular belts & sprockets	Chain & belt return systems	Frame & structure supports	Bearing supports	
Curves & tracks	Side guide solutions	Miscellaneous products	Equipment	

SYSTEM PLAST®



3 0 0 6 0 a

www.SystemPlastSmartGuide.com

12,7 mm (1/2") MODULAR BELTS 2120

FLAT TOP VERSION WITH POSITIONERS

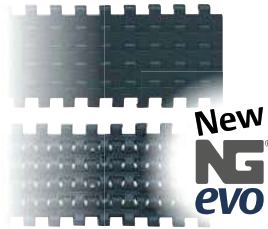

NG® evo conveyor components made from engineered plastic resin
 Longer wearlife than acetal
 Lower friction than acetal
 Good chemical resistance
 High abrasion resistance
 It meets the requirement for materials as stated by EC1935/2004 and FDA CFR21 norms for direct food contact
 Less dust than with acetal chains
 More.....

2120 FT-P



2120 FT-P2

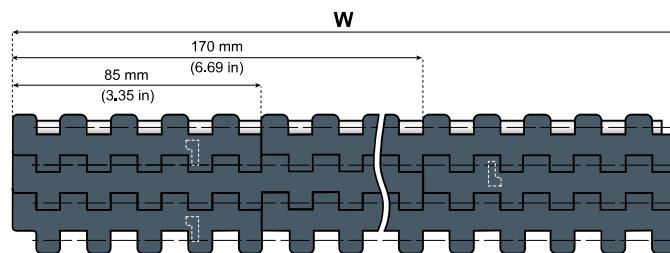
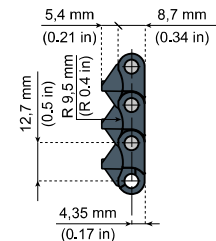

Backflex radius: 10 mm (0,4 in)
Max load capacity: 20000 N/m (1400 lbs/ft.)
Weight: 8,6 Kg/m² (1,75 lbs/ft².)
Pin material: PBT (white)
Standard length:
 width ≤ 340 mm (13,39 in) : 3,048 m (10 ft.)
 width > 340 mm (13,39 in) ≤ 1700 mm (66,93 in) : 1,524 m (5 ft.)
 width > 1700 mm (66,93 in) : on request

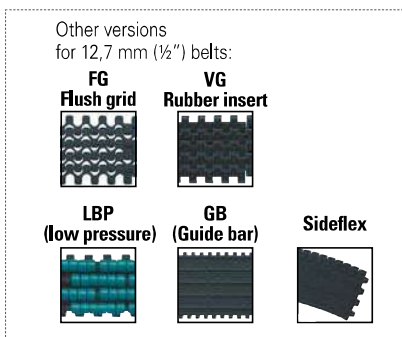
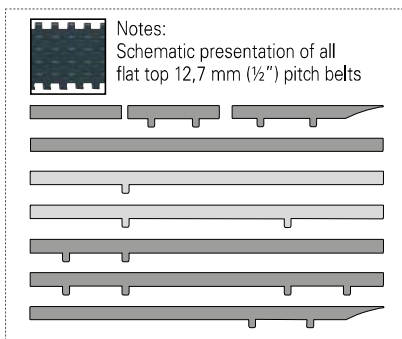

Information about this product is only available on our Smart Guide® website.

Standard material
NGE (GREY BLUE)
 New Generation®

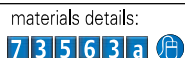

WIDTH W		ITEM DESCRIPTION	ITEM DESCRIPTION
mm	in		
85	3.35	NGE2120FT-P-M0085	-
170	6.69	NGE2120FT-P-M0170	NGE2120FT-P2-M0170
255	10.04	NGE2120FT-P-M0255	NGE2120FT-P2-M0255
340	13.39	NGE2120FT-P-M0340	NGE2120FT-P2-M0340
425	16.73	NGE2120FT-P-M0425	NGE2120FT-P2-M0425
510	20.08	NGE2120FT-P-M0510	NGE2120FT-P2-M0510
595	23.43	NGE2120FT-P-M0595	NGE2120FT-P2-M0595
680	26.77	NGE2120FT-P-M0680	NGE2120FT-P2-M0680
765	30.12	NGE2120FT-P-M0765	NGE2120FT-P2-M0765
850	33.46	NGE2120FT-P-M0850	NGE2120FT-P2-M0850
935	36.81	NGE2120FT-P-M0935	NGE2120FT-P2-M0935
1020	40.16	NGE2120FT-P-M1020	NGE2120FT-P2-M1020
1105	43.50	NGE2120FT-P-M1105	NGE2120FT-P2-M1105
1190	46.85	NGE2120FT-P-M1190	NGE2120FT-P2-M1190
1275	50.20	NGE2120FT-P-M1275	NGE2120FT-P2-M1275
1360	53.54	NGE2120FT-P-M1360	NGE2120FT-P2-M1360
1445	56.89	NGE2120FT-P-M1445	NGE2120FT-P2-M1445
1530	60.24	NGE2120FT-P-M1530	NGE2120FT-P2-M1530
1615	63.58	NGE2120FT-P-M1615	NGE2120FT-P2-M1615
1700	66.93	NGE2120FT-P-M1700	NGE2120FT-P2-M1700
1785	70.28	NGE2120FT-P-M1785	NGE2120FT-P2-M1785
1870	73.62	NGE2120FT-P-M1870	NGE2120FT-P2-M1870

Other widths available on request.

Chains & sprockets	Wear strips	Side guide brackets & accessories	Levelers	Engineering manual
Modular belts & sprockets	Chain & belt return systems	Frame & structure supports	Bearing supports	
Curves & tracks	Side guide solutions	Miscellaneous products	Equipment	

30060b

www.SystemPlastSmartGuide.com

12,7 mm (½") MODULAR BELTS 2120

FLAT TOP VERSION WITH TWIN POSITIONERS



LFG



New
NG
evo

NG® evo conveyor components made from engineered plastic resin

Longer wearlife than acetal
Lower friction than acetal
Good chemical resistance
High abrasion resistance
It meets the requirement for materials as stated by EC1935/2004 and FDA CFR21 norms for direct food contact
Less dust than with acetal chains
More.....

Backflex radius: 10 mm (0,4 in)

Max load capacity (LFG): 20000 N/m (1400 lbs/ft.)

Weight: 8,6 Kg/m² (1,75 lbs/ft².)

Pin material: PBT (white)

Standard length:

width ≤ 340 mm (13,39 in): 3,048 m (10 ft.)

width > 340 mm (13,39 in) ≤ 1700 mm (66,93 in): 1,524 m (5 ft.)

width > 1700 mm (66,93 in): on request

2120 FT-PT

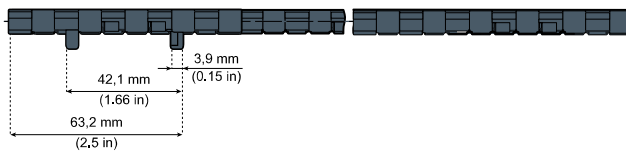

2120FT-PT2

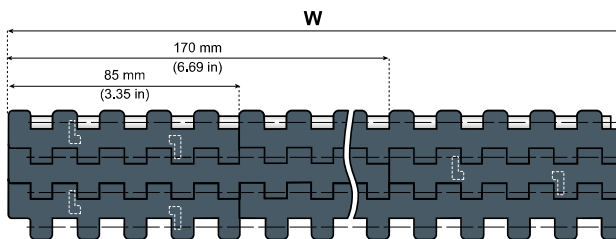
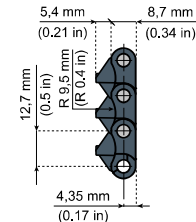
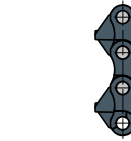
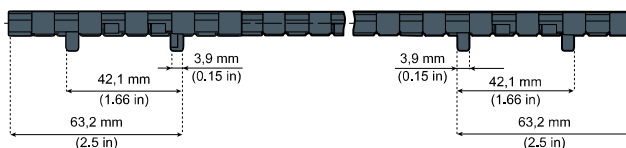

Other versions for 12,7 mm (½") belts:

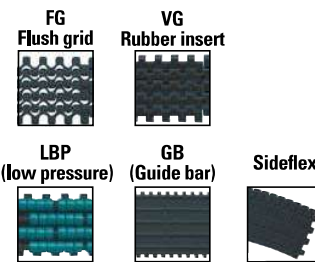

Notes:
Schematic presentation of all flat top 12,7 mm (½") pitch belts

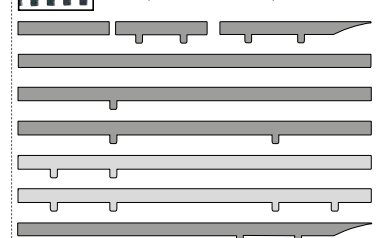

30160a



Information about this product is only available on our Smart Guide® website.

Standard material

NGE (GREY BLUE)

New Generation®

LFG (GREY)

Low friction acetal resin

materials details:

73563a

WIDTH W		ITEM DESCRIPTION	
mm	in	NGE (GREY BLUE)	LFG (GREY)
85	3.35	NGE2120FT-PT-M0085	LFG2120FT-PT-M0085
170	6.69	NGE2120FT-PT-M0170	LFG2120FT-PT-M0170
255	10.04	NGE2120FT-PT-M0255	LFG2120FT-PT-M0255
340	13.39	NGE2120FT-PT-M0340	LFG2120FT-PT-M0340
425	16.73	NGE2120FT-PT-M0425	LFG2120FT-PT-M0425
510	20.08	NGE2120FT-PT-M0510	LFG2120FT-PT-M0510
595	23.43	NGE2120FT-PT-M0595	LFG2120FT-PT-M0595
680	26.77	NGE2120FT-PT-M0680	LFG2120FT-PT-M0680
765	30.12	NGE2120FT-PT-M0765	LFG2120FT-PT-M0765
850	33.46	NGE2120FT-PT-M0850	LFG2120FT-PT-M0850
935	36.81	NGE2120FT-PT-M0935	LFG2120FT-PT-M0935
1020	40.16	NGE2120FT-PT-M1020	LFG2120FT-PT-M1020
1105	43.50	NGE2120FT-PT-M1105	LFG2120FT-PT-M1105
1190	46.85	NGE2120FT-PT-M1190	LFG2120FT-PT-M1190
1275	50.20	NGE2120FT-PT-M1275	LFG2120FT-PT-M1275
1360	53.54	NGE2120FT-PT-M1360	LFG2120FT-PT-M1360
1445	56.89	NGE2120FT-PT-M1445	LFG2120FT-PT-M1445
1530	60.24	NGE2120FT-PT-M1530	LFG2120FT-PT-M1530
1615	63.58	NGE2120FT-PT-M1615	LFG2120FT-PT-M1615
1700	66.93	NGE2120FT-PT-M1700	LFG2120FT-PT-M1700
1785	70.28	NGE2120FT-PT-M1785	LFG2120FT-PT-M1785
1870	73.62	NGE2120FT-PT-M1870	LFG2120FT-PT-M1870

ITEM DESCRIPTION	
NGE (GREY BLUE)	LFG (GREY)
-	-
NGE2120FT-PT2-M0170	LFG2120FT-PT2-M0170
NGE2120FT-PT2-M0255	LFG2120FT-PT2-M0255
NGE2120FT-PT2-M0340	LFG2120FT-PT2-M0340
NGE2120FT-PT2-M0425	LFG2120FT-PT2-M0425
NGE2120FT-PT2-M0510	LFG2120FT-PT2-M0510
NGE2120FT-PT2-M0595	LFG2120FT-PT2-M0595
NGE2120FT-PT2-M0680	LFG2120FT-PT2-M0680
NGE2120FT-PT2-M0765	LFG2120FT-PT2-M0765
NGE2120FT-PT2-M0850	LFG2120FT-PT2-M0850
NGE2120FT-PT2-M0935	LFG2120FT-PT2-M0935
NGE2120FT-PT2-M1020	LFG2120FT-PT2-M1020
NGE2120FT-PT2-M1105	LFG2120FT-PT2-M1105
NGE2120FT-PT2-M1190	LFG2120FT-PT2-M1190
NGE2120FT-PT2-M1275	LFG2120FT-PT2-M1275
NGE2120FT-PT2-M1360	LFG2120FT-PT2-M1360
NGE2120FT-PT2-M1445	LFG2120FT-PT2-M1445
NGE2120FT-PT2-M1530	LFG2120FT-PT2-M1530
NGE2120FT-PT2-M1615	LFG2120FT-PT2-M1615
NGE2120FT-PT2-M1700	LFG2120FT-PT2-M1700
NGE2120FT-PT2-M1785	LFG2120FT-PT2-M1785
NGE2120FT-PT2-M1870	LFG2120FT-PT2-M1870

Other widths available on request.

Chains & sprockets	Wear strips	Side guide brackets & accessories	Levelers	Engineering manual
Modular belts & sprockets	Chain & belt return systems	Frame & structure supports	Bearing supports	
Curves & tracks	Side guide solutions	Miscellaneous products	Equipment	

SYSTEM PLAST®



3 0 0 7 0 a

www.SystemPlastSmartGuide.com

12,7 mm (½") MODULAR BELTS 2120

FLUSH GRID VERSION - 85 mm (3.35 in) MODULES

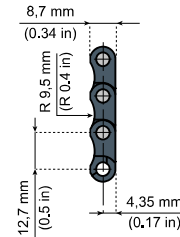
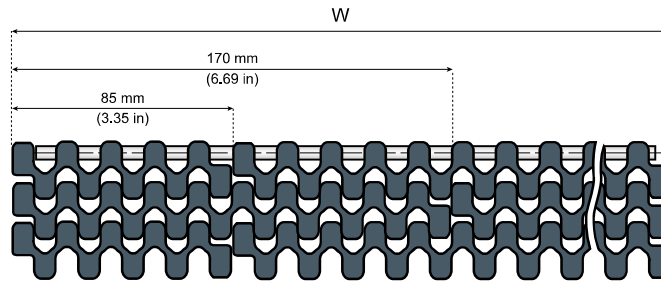
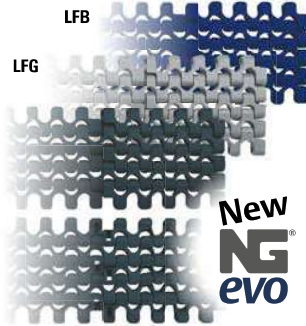

NG® evo conveyor components
made from engineered plastic resin

- Longer wearlife than acetal
- Lower friction than acetal
- Good chemical resistance
- High abrasion resistance
- It meets the requirement for materials as stated by EC1935/2004 and FDA CFR21 norms for direct food contact
- Less dust than with acetal chains
- More.....

Backflex radius: 10 mm (0,39 in)
Max load capacity (LFG & LFB): 20000 N/m (1400 lbs/ft.)

Weight: 7,4 Kg/m² (1,51 lbs/ft².)

Pin material: PBT (white)

Standard length:

- width ≤ 340 mm (13,39 in): 3,048 m (10 ft.)
- width > 340 mm (13,39 in) ≤ 1700 mm (66,93 in) : 1,524 m (5 ft.)
- width > 1700 mm (66,93 in): on request

Open surface: 21%

Usually used on short conveyors with a Nose Bar to create extremely short transfers

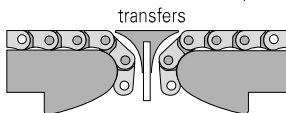

page code: **3 0 1 7 5 a**



Notes:
Schematic presentation of all flush grid 12,7 mm (½") pitch belts



3 0 1 6 0 a



Information about this product is only available on our Smart Guide® website.

Other versions for 12,7 mm (½") belts:

FT Flat top **VG Rubber insert**



LBP (low pressure) **GB (Guide bar)**



Sidexflex

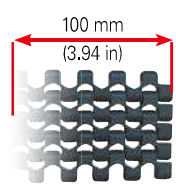

Also available with 100 mm (3,94 in) modules. Go to:

3 0 0 7 3 a

Standard materials

NGE (GREY BLUE)	LFG (GREY)	LFB (BLUE)
New Generation®	Low friction acetal resin	

materials details:

7 3 5 6 3 a

WIDTH W		ITEM DESCRIPTION		
mm	in	NGE (GREY BLUE)	LFG (GREY)	LFB (BLUE)
85	3.35	NGE2120FG-M0085	LFG2120FG-M0085	LFB2120FG-M0085
170	6.69	NGE2120FG-M0170	LFG2120FG-M0170	LFB2120FG-M0170
255	10.04	NGE2120FG-M0255	LFG2120FG-M0255	LFB2120FG-M0255
340	13.39	NGE2120FG-M0340	LFG2120FG-M0340	LFB2120FG-M0340
425	16.73	NGE2120FG-M0425	LFG2120FG-M0425	LFB2120FG-M0425
510	20.08	NGE2120FG-M0510	LFG2120FG-M0510	LFB2120FG-M0510
595	23.43	NGE2120FG-M0595	LFG2120FG-M0595	LFB2120FG-M0595
680	26.77	NGE2120FG-M0680	LFG2120FG-M0680	LFB2120FG-M0680
765	30.12	NGE2120FG-M0765	LFG2120FG-M0765	LFB2120FG-M0765
850	33.46	NGE2120FG-M0850	LFG2120FG-M0850	LFB2120FG-M0850
935	36.81	NGE2120FG-M0935	LFG2120FG-M0935	LFB2120FG-M0935
1020	40.16	NGE2120FG-M1020	LFG2120FG-M1020	LFB2120FG-M1020
1105	43.50	NGE2120FG-M1105	LFG2120FG-M1105	LFB2120FG-M1105
1190	46.85	NGE2120FG-M1190	LFG2120FG-M1190	LFB2120FG-M1190
1275	50.20	NGE2120FG-M1275	LFG2120FG-M1275	LFB2120FG-M1275
1360	53.54	NGE2120FG-M1360	LFG2120FG-M1360	LFB2120FG-M1360
1445	56.89	NGE2120FG-M1445	LFG2120FG-M1445	LFB2120FG-M1445
1530	60.24	NGE2120FG-M1530	LFG2120FG-M1530	LFB2120FG-M1530
1615	63.58	NGE2120FG-M1615	LFG2120FG-M1615	LFB2120FG-M1615
1700	66.93	NGE2120FG-M1700	LFG2120FG-M1700	LFB2120FG-M1700
1785	70.28	NGE2120FG-M1785	LFG2120FG-M1785	LFB2120FG-M1785
1870	73.62	NGE2120FG-M1870	LFG2120FG-M1870	LFB2120FG-M1870
1955	76.97	NGE2120FG-M1955	LFG2120FG-M1955	LFB2120FG-M1955
2040	80.31	NGE2120FG-M2040	LFG2120FG-M2040	LFB2120FG-M2040
2125	83.66	NGE2120FG-M2125	LFG2120FG-M2125	LFB2120FG-M2125
2210	87.01	NGE2120FG-M2210	LFG2120FG-M2210	LFB2120FG-M2210
2295	90.35	NGE2120FG-M2295	LFG2120FG-M2295	LFB2120FG-M2295

Other widths available on request.

Chains & sprockets	Wear strips	Side guide brackets & accessories	Levelers	Engineering manual
Modular belts & sprockets	Chain & belt return systems	Frame & structure supports	Bearing supports	
Curves & tracks	Side guide solutions	Miscellaneous products	Equipment	

3 0 0 7 3 a

www.SystemPlastSmartGuide.com

12,7 mm (½") MODULAR BELTS 2122

FLUSH GRID VERSION - 100 mm MODULES (3.94 in)

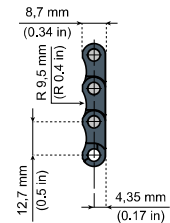
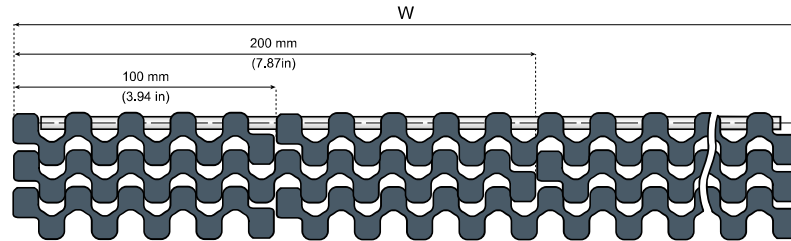

NG® evo conveyor components made from engineered plastic resin

- Longer wearlife than acetal
- Lower friction than acetal
- Good chemical resistance
- High abrasion resistance
- It meets the requirement for materials as stated by EC1935/2004 and FDA CFR21 norms for direct food contact
- Less dust than with acetal chains
- More.....

Backflex radius: 10 mm (0,39 in)

Max load capacity: 18000 N/m (1260 lbs/ft.)

Weight: 6,8 Kg/m² (1,39 lbs/ft².)

Pin material: PBT (white)

Standard length:

width ≤ 400 mm (15.75 in): 3,048 m (10 ft.)

width > 400 mm (15.75 in) ≤ 1700 mm (66.93 in) : 1,524 m (5 ft.)

width > 1700 mm (66.93 in): on request

Open surface: 21%.

2122 FG belts are similar to 2120FG belts.

The difference is the width of the modules.

Standard increments are 100 mm (3.94 in).

Special widths can be created on request in steps of 20 mm (0.79 in).



Information about this product is only available on our Smart Guide® website.

Standard material

NGE (GREY BLUE)

New Generation®

materials details:

7 3 5 6 3 a

Usually used on short conveyors with a Nose Bar to create extremely short transfers

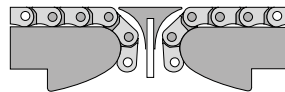

page code: **3 0 1 7 5 a**

Also available with 85 mm (3,35 in) modules. Go to:

3 0 0 7 0 a

Notes:
Schematic presentation of all flush grid 12,7 mm (½") pitch belts

Other versions for 12,7 mm (½") belts:

- FT Flat top**
- VG Rubber insert**
- LBP (low pressure)**
- GB (Guide bar)**
- Sideflex**

WIDTH W		ITEM DESCRIPTION
mm	in	
100	3.94	NGE2122FG-M0100
200	7.87	NGE2122FG-M0200
300	11.81	NGE2122FG-M0300
400	15.75	NGE2122FG-M0400
500	19.69	NGE2122FG-M0500
600	23.62	NGE2122FG-M0600
700	27.56	NGE2122FG-M0700
800	31.50	NGE2122FG-M0800
900	35.43	NGE2122FG-M0900
1000	39.37	NGE2122FG-M1000
1100	43.30	NGE2122FG-M1100
1200	47.24	NGE2122FG-M1200
1300	51.18	NGE2122FG-M1300
1400	55.12	NGE2122FG-M1400
1500	59.06	NGE2122FG-M1500
1600	62.99	NGE2122FG-M1600
1700	66.93	NGE2122FG-M1700
1800	70.87	NGE2122FG-M1800
1900	74.80	NGE2122FG-M1900
2000	78.74	NGE2122FG-M2000
2100	82.68	NGE2122FG-M2100

Other widths available on request.

Chains & sprockets	Wear strips	Side guide brackets & accessories	Levelers	Engineering manual
Modular belts & sprockets	Chain & belt return systems	Frame & structure supports	Bearing supports	
Curves & tracks	Side guide solutions	Miscellaneous products	Equipment	

SYSTEM PLAST®



3 0 0 7 5 a

12,7 mm (1/2") MODULAR BELTS 2120

www.SystemPlastSmartGuide.com

FLUSH GRID VERSION WITH POSITIONERS



New NGEvo

2120FG-P

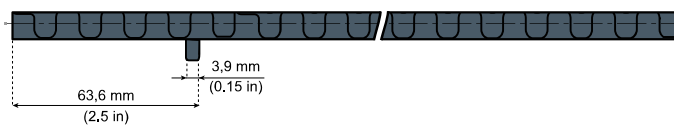

2120FG-P2

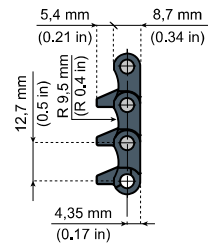
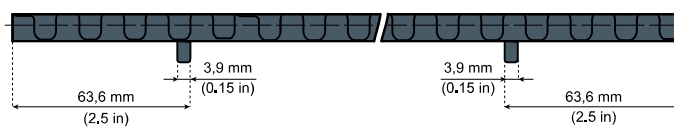

NG® evo conveyor components made from engineered plastic resin

- Longer wearlife than acetal
- Lower friction than acetal
- Good chemical resistance
- High abrasion resistance
- It meets the requirement for materials as stated by EC1935/2004 and FDA CFR21 norms for direct food contact
- Less dust than with acetal chains
- More.....

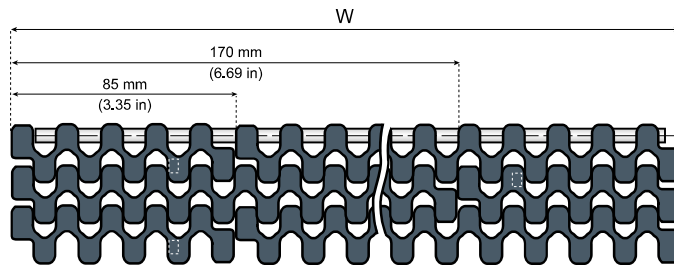

Backflex radius: 10 mm (0.39 in)

Max load capacity: 18000 N/m (1260 lbs/ft.)

Weight: 7.4 Kg/m² (1.51 lbs/ft².)

Pin material: PBT (white)

Standard length:

width ≤ 340 mm (13.39 in): 3,048 m (10 ft.)

width > 340 mm (13.39 in) ≤ 1700 mm (66.93 in) : 1,524 m (5 ft.)

width > 1700 mm (66.93 in): on request

Open surface: 21%



Notes:
Schematic presentation of all flush grid 12,7 mm (1/2") pitch belts

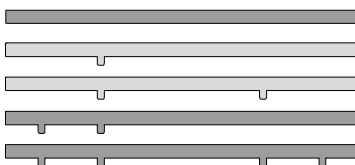

Other versions for 12,7 mm (1/2") belts:

FT
Flat top



VG
Rubber insert



LBP
(low pressure)



GB
(Guide bar)



Sideflex



3 0 1 6 0 a



Information about this product is only available on our Smart Guide® website.

Standard material

NGE (GREY BLUE)

New Generation®

materials details:

7 3 5 6 3 a

WIDTH W		ITEM DESCRIPTION	ITEM DESCRIPTION
mm	in		
85	3.35	NGE2120FG-P-M0085	-
170	6.69	NGE2120FG-P-M0170	NGE2120FG-P2-M0170
255	10.04	NGE2120FG-P-M0255	NGE2120FG-P2-M0255
340	13.39	NGE2120FG-P-M0340	NGE2120FG-P2-M0340
425	16.73	NGE2120FG-P-M0425	NGE2120FG-P2-M0425
510	20.08	NGE2120FG-P-M0510	NGE2120FG-P2-M0510
595	23.43	NGE2120FG-P-M0595	NGE2120FG-P2-M0595
680	26.77	NGE2120FG-P-M0680	NGE2120FG-P2-M0680
765	30.12	NGE2120FG-P-M0765	NGE2120FG-P2-M0765
850	33.46	NGE2120FG-P-M0850	NGE2120FG-P2-M0850
935	36.81	NGE2120FG-P-M0935	NGE2120FG-P2-M0935
1020	40.16	NGE2120FG-P-M1020	NGE2120FG-P2-M1020
1105	43.50	NGE2120FG-P-M1105	NGE2120FG-P2-M1105
1190	46.85	NGE2120FG-P-M1190	NGE2120FG-P2-M1190
1275	50.20	NGE2120FG-P-M1275	NGE2120FG-P2-M1275
1360	53.54	NGE2120FG-P-M1360	NGE2120FG-P2-M1360
1445	56.89	NGE2120FG-P-M1445	NGE2120FG-P2-M1445
1530	60.24	NGE2120FG-P-M1530	NGE2120FG-P2-M1530
1615	63.58	NGE2120FG-P-M1615	NGE2120FG-P2-M1615
1700	66.93	NGE2120FG-P-M1700	NGE2120FG-P2-M1700
1785	70.28	NGE2120FG-P-M1785	NGE2120FG-P2-M1785
1870	73.62	NGE2120FG-P-M1870	NGE2120FG-P2-M1870

Other widths available on request.

Chains & sprockets	Wear strips	Side guide brackets & accessories	Levelers	Engineering manual
Modular belts & sprockets	Chain & belt return systems	Frame & structure supports	Bearing supports	
Curves & tracks	Side guide solutions	Miscellaneous products	Equipment	



30075b

www.SystemPlastSmartGuide.com

12,7 mm (½") MODULAR BELTS 2120

FLUSH GRID VERSION WITH TWIN POSITIONERS



NG® evo conveyor components made from engineered plastic resin
 Longer wearlife than acetal
 Lower friction than acetal
 Good chemical resistance
 High abrasion resistance
 It meets the requirement for materials as stated by EC1935/2004 and FDA CFR21 norms for direct food contact
 Less dust than with acetal chains
 More.....

2120FG-PT



2120FG-PT2

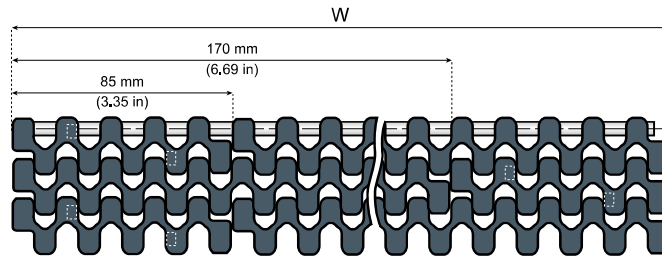
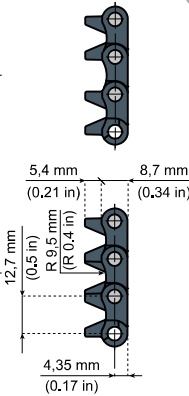

- Backflex radius:** 10 mm (0,39 in)
- Max load capacity:** 18000 N/m (1260 lbs/ft.)
- Weight:** 7,4 Kg/m² (1,51 lbs/ft².)
- Pin material:** PBT (white)
- Standard length:**
 - width ≤ 340 mm (13,39 in): 3,048 m (10 ft.)
 - width > 340 mm (13,39 in) ≤ 1700 mm (66,93 in) : 1,524 m (5 ft.)
 - width > 1700 mm (66,93 in): on request
- Open surface:** 21%



Notes:
Schematic presentation of all flush grid 12,7 mm (½") pitch belts



Other versions for 12,7 mm (½") belts:

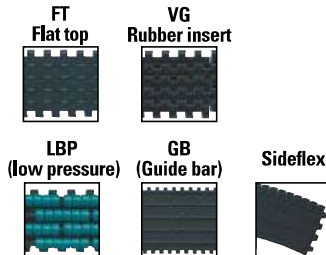

Information about this product is only available on our Smart Guide® website.

Standard material

NGE (GREY BLUE)

New Generation®

materials details:



WIDTH W		ITEM DESCRIPTION	ITEM DESCRIPTION
mm	in		
85	3.35	NGE2120FG-PT-M0085	-
170	6.69	NGE2120FG-PT-M0170	NGE2120FG-PT2-M0170
255	10.04	NGE2120FG-PT-M0255	NGE2120FG-PT2-M0255
340	13.39	NGE2120FG-PT-M0340	NGE2120FG-PT2-M0340
425	16.73	NGE2120FG-PT-M0425	NGE2120FG-PT2-M0425
510	20.08	NGE2120FG-PT-M0510	NGE2120FG-PT2-M0510
595	23.43	NGE2120FG-PT-M0595	NGE2120FG-PT2-M0595
680	26.77	NGE2120FG-PT-M0680	NGE2120FG-PT2-M0680
765	30.12	NGE2120FG-PT-M0765	NGE2120FG-PT2-M0765
850	33.46	NGE2120FG-PT-M0850	NGE2120FG-PT2-M0850
935	36.81	NGE2120FG-PT-M0935	NGE2120FG-PT2-M0935
1020	40.16	NGE2120FG-PT-M1020	NGE2120FG-PT2-M1020
1105	43.50	NGE2120FG-PT-M1105	NGE2120FG-PT2-M1105
1190	46.85	NGE2120FG-PT-M1190	NGE2120FG-PT2-M1190
1275	50.20	NGE2120FG-PT-M1275	NGE2120FG-PT2-M1275
1360	53.54	NGE2120FG-PT-M1360	NGE2120FG-PT2-M1360
1445	56.89	NGE2120FG-PT-M1445	NGE2120FG-PT2-M1445
1530	60.24	NGE2120FG-PT-M1530	NGE2120FG-PT2-M1530
1615	63.58	NGE2120FG-PT-M1615	NGE2120FG-PT2-M1615
1700	66.93	NGE2120FG-PT-M1700	NGE2120FG-PT2-M1700
1785	70.28	NGE2120FG-PT-M1785	NGE2120FG-PT2-M1785
1870	73.62	NGE2120FG-PT-M1870	NGE2120FG-PT2-M1870

Other widths available on request.

Chains & sprockets	Wear strips	Side guide brackets & accessories	Levelers	Engineering manual
Modular belts & sprockets	Chain & belt return systems	Frame & structure supports	Bearing supports	
Curves & tracks	Side guide solutions	Miscellaneous products	Equipment	

30090a

12,7 mm (1/2") MODULAR BELTS

www.SystemPlastSmartGuide.com

RUBBER INSERT



New
NG
evo

Single track

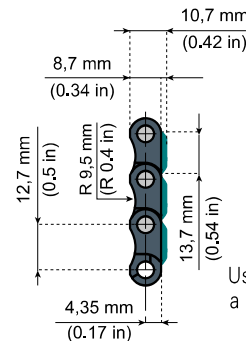
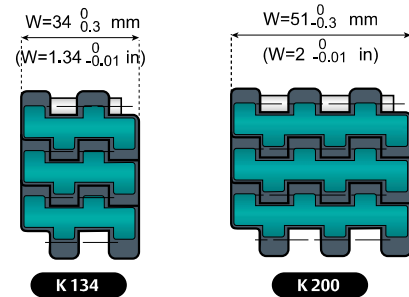

Usually used on short conveyors with a Nose Bar to create extremely short transfers

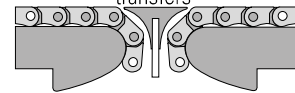

page code: **30175a**

NG® evo conveyor components made from engineered plastic resin
 Longer wearlife than acetal
 Lower friction than acetal
 Good chemical resistance
 High abrasion resistance
 It meets the requirement for materials as stated by EC1935/2004 and FDA CFR21 norms for direct food contact
 Less dust than with acetal chains
 More.....

Rubber material: thermoplastic rubber, water blue color, 75 shore A. **Pin material:** PBT (white)

ITEM DESCRIPTION	MATERIAL	WIDTH W		PITCH P		BACKFLEX RADIUS		MAX LOAD CAPACITY		WEIGHT	
		mm	in	mm	in	mm	in	N	lbs	Kg/m	lbs/ft.
NGE2124FT-K134VG	NGE	34	1.34	12,7	0,5	20	0,79	300	65	0,4	0,27
NGE2121FT-K200VG	Grey Blue	51	2	12,7	0,5	20	0,79	680	150	0,55	0,37

Standard length: 240 pitches (3,048 m - 5 ft.)

Single track with positioners

New
NG
evo

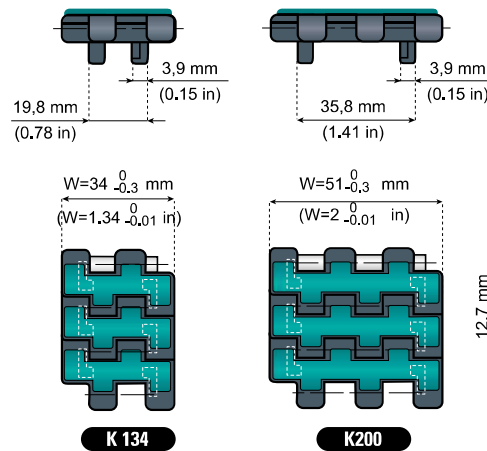

For belts **2121 FT**
30160a



For belts **2124 FT**
30165a

Information about this product is only available on our Smart Guide® website.

ITEM DESCRIPTION	MATERIAL	WIDTH W		PITCH P		BACKFLEX RADIUS		MAX LOAD CAPACITY		WEIGHT	
		mm	in	mm	in	mm	in	N	lbs	Kg/m	lbs/ft.
NGE2124FT-PT-K134VG	NGE	34	1.34	12,7	0,5	20	0,79	300	65	0,4	0,27
NGE2121FT-PT-K200VG	Grey Blue	51	2	12,7	0,5	20	0,79	680	150	0,55	0,37

Standard length: 240 pitches (3,048 m - 5 ft.)

Standard material

NGE (GREY BLUE)

New Generation®

materials details:

73563a

TPR (WATER BLUE)

Thermoplastic rubber

materials details:

73570a



Information about this product is only available on our Smart Guide® website.

Other versions for 12,7 mm (1/2") belts:

FT

Flat top



FG

Flush grid



LBP

(low pressure)



GB

(Guide bar)



Sideflex



Notes:
Schematic presentation of all VG rubber insert 12,7 mm (1/2") pitch belts

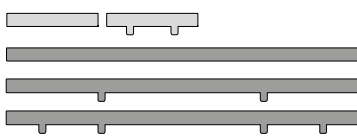

Chains & sprockets	Wear strips	Side guide brackets & accessories	Levelers	Engineering manual
Modular belts & sprockets	Chain & belt return systems	Frame & structure supports	Bearing supports	
Curves & tracks	Side guide solutions	Miscellaneous products	Equipment	

SYSTEM PLAST®



3 0 1 0 0 a

12,7 mm (½") MODULAR BELTS

www.SystemPlastSmartGuide.com

RUBBER INSERT EVERY PITCH

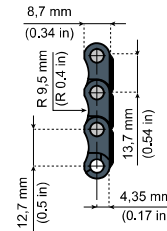
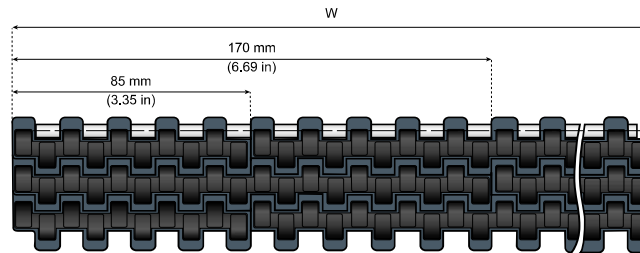
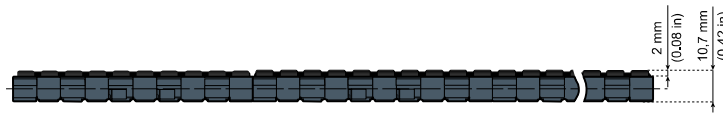

NG® evo conveyor components
made from engineered plastic resin

- Longer wearlife than acetal
- Lower friction than acetal
- Good chemical resistance
- High abrasion resistance
- It meets the requirement for materials as stated by EC1935/2004 and FDA CFR21 norms for direct food contact
- Less dust than with acetal chains
- More.....

- Belt material:** grey blue colour
- Rubber material:** thermoplastic rubber, black colour, 50 shore A.
- Backflex radius:** 20 mm (0.8 in)
- Max load capacity:** 18000 N/m (1260 lbs/ft.)
- Pin material:** PBT (white)
- Standard length:**
 - width ≤ 340 mm (13.39 in): 3,048 m (10 ft.)
 - width > 340 mm (13.39 in) ≤ 1700 mm (66.93 in) : 1,524 m (5 ft.)
 - width > 1700 mm (66.93 in): on request

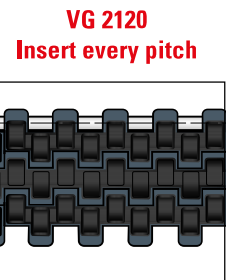

Weight:
9,7 Kg/m² (1.98 lbs/ft².)

Usually used on short conveyors with a Nose Bar to create extremely short transfers

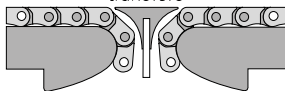

page code: **3 0 1 7 5 a**



Notes:
Schematic presentation of all VG rubber insert 12,7 mm (½") pitch belts

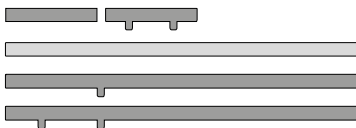

Information about this product is only available on our Smart Guide® website.

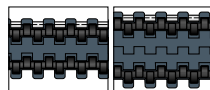

For insert every 2nd or 3th pitch, go to:

3 0 1 0 0 b



3 0 1 6 0 a

Standard material

NGE (GREY BLUE)

New Generation®

materials details:

7 3 5 6 3 a

TPR (BLACK)

Thermoplastic rubber

materials details:

7 3 5 7 0 a

Other versions for 12,7 mm (½") belts:

FT
Flat top



FG
Flush grid



LBP
(low pressure)



GB
(Guide bar)



Sideflex



Also available with side indent. Go to:

3 0 1 0 5 a

WIDTH W		ITEM DESCRIPTION
mm	in	
85	3.35	NGE2120FT-M0085VG50
170	6.69	NGE2120FT-M0170VG50
255	10.04	NGE2120FT-M0255VG50
340	13.39	NGE2120FT-M0340VG50
425	16.73	NGE2120FT-M0425VG50
510	20.08	NGE2120FT-M0510VG50
595	23.43	NGE2120FT-M0595VG50
680	26.77	NGE2120FT-M0680VG50
765	30.12	NGE2120FT-M0765VG50
850	33.46	NGE2120FT-M0850VG50
935	36.81	NGE2120FT-M0935VG50
1020	40.16	NGE2120FT-M1020VG50
1105	43.50	NGE2120FT-M1105VG50
1190	46.85	NGE2120FT-M1190VG50
1275	50.20	NGE2120FT-M1275VG50
1360	53.54	NGE2120FT-M1360VG50
1445	56.89	NGE2120FT-M1445VG50
1530	60.24	NGE2120FT-M1530VG50
1615	63.58	NGE2120FT-M1615VG50
1700	66.93	NGE2120FT-M1700VG50
1785	70.28	NGE2120FT-M1785VG50
1870	73.62	NGE2120FT-M1870VG50
1955	76.97	NGE2120FT-M1955VG50
2040	80.31	NGE2120FT-M2040VG50

Other widths available on request.

Chains & sprockets	Wear strips	Side guide brackets & accessories	Levelers	Engineering manual
Modular belts & sprockets	Chain & belt return systems	Frame & structure supports	Bearing supports	
Curves & tracks	Side guide solutions	Miscellaneous products	Equipment	

SYSTEM PLAST®



30100b

www.SystemPlastSmartGuide.com

12,7 mm (1/2") MODULAR BELTS

RUBBER INSERT EVERY 2nd & 3th PITCH



New NG evo

NG® evo conveyor components
made from engineered plastic resin

- Longer wearlife than acetal
- Lower friction than acetal
- Good chemical resistance
- High abrasion resistance
- It meets the requirement for materials as stated by EC1935/2004 and FDA CFR21 norms for direct food contact
- Less dust than with acetal chains
- More.....

Belt material: grey blue colour

Rubber material: thermoplastic rubber, black colour, 50 shore A.

Backflex radius: 20 mm (0,8 in)

Max load capacity: 18000 N/m (1260 lbs/ft.)

Pin material: PBT (white)

Standard length:

width ≤ 340 mm (13.39 in): 3,048 m (10 ft.)

width > 340 mm (13.39 in) ≤ 1700 mm (66.93 in):

1,524 m (5 ft.)

width > 1700 mm (66.93 in): on request



Usually used on short conveyors with a Nose Bar to create extremely short transfers

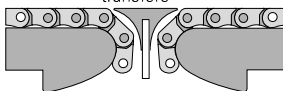

page code: **30175a**



Notes:
Schematic presentation of all VG rubber insert 12,7 mm (1/2") pitch belts

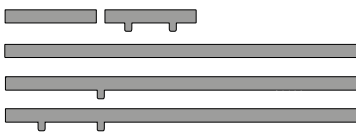

Other versions for 12,7 mm (1/2") belts:

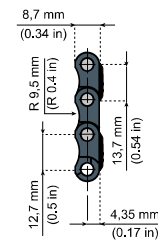
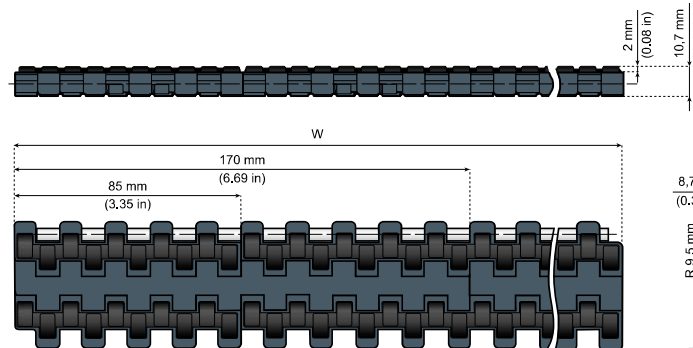
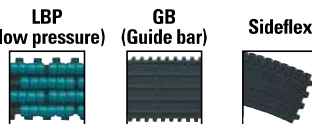
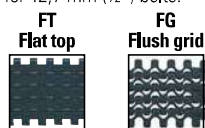

Information about this product is only available on our Smart Guide® website.

Standard material

NGE (GREY BLUE)

New Generation®

materials details:



TPR (BLACK)

Thermoplastic rubber

materials details:

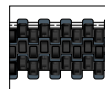

For every insert, go to:



Also available with side indent. Go to:



VG2 2120
Insert every 2nd pitch

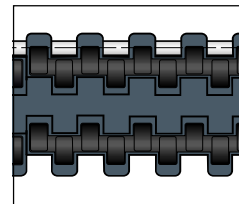

Weight:

9,2 Kg/m² (1.88 lbs/ft.²)

VG3 2120
Insert every 3th pitch

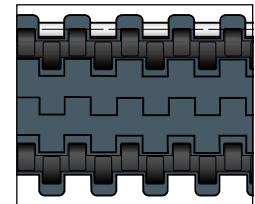

Weight:

9,0 Kg/m² (1.84 lbs/ft.²)

WIDTH W		ITEM DESCRIPTION	ITEM DESCRIPTION
mm	in		
85	3.35	NGE2120FT-M0085VG50-2	NGE2120FT-M0085VG50-3
170	6.69	NGE2120FT-M0170VG50-2	NGE2120FT-M0170VG50-3
255	10.04	NGE2120FT-M0255VG50-2	NGE2120FT-M0255VG50-3
340	13.39	NGE2120FT-M0340VG50-2	NGE2120FT-M0340VG50-3
425	16.73	NGE2120FT-M0425VG50-2	NGE2120FT-M0425VG50-3
510	20.08	NGE2120FT-M0510VG50-2	NGE2120FT-M0510VG50-3
595	23.43	NGE2120FT-M0595VG50-2	NGE2120FT-M0595VG50-3
680	26.77	NGE2120FT-M0680VG50-2	NGE2120FT-M0680VG50-3
765	30.12	NGE2120FT-M0765VG50-2	NGE2120FT-M0765VG50-3
850	33.46	NGE2120FT-M0850VG50-2	NGE2120FT-M0850VG50-3
935	36.81	NGE2120FT-M0935VG50-2	NGE2120FT-M0935VG50-3
1020	40.16	NGE2120FT-M1020VG50-2	NGE2120FT-M1020VG50-3
1105	43.50	NGE2120FT-M1105VG50-2	NGE2120FT-M1105VG50-3
1190	46.85	NGE2120FT-M1190VG50-2	NGE2120FT-M1190VG50-3
1275	50.20	NGE2120FT-M1275VG50-2	NGE2120FT-M1275VG50-3
1360	53.54	NGE2120FT-M1360VG50-2	NGE2120FT-M1360VG50-3
1445	56.89	NGE2120FT-M1445VG50-2	NGE2120FT-M1445VG50-3
1530	60.24	NGE2120FT-M1530VG50-2	NGE2120FT-M1530VG50-3
1615	63.58	NGE2120FT-M1615VG50-2	NGE2120FT-M1615VG50-3
1700	66.93	NGE2120FT-M1700VG50-2	NGE2120FT-M1700VG50-3
1785	70.28	NGE2120FT-M1785VG50-2	NGE2120FT-M1785VG50-3
1870	73.62	NGE2120FT-M1870VG50-2	NGE2120FT-M1870VG50-3
1955	76.97	NGE2120FT-M1955VG50-2	NGE2120FT-M1955VG50-3
2040	80.31	NGE2120FT-M2040VG50-2	NGE2120FT-M2040VG50-3

Other widths available on request.

Chains & sprockets	Wear strips	Side guide brackets & accessories	Levelers	Engineering manual
Modular belts & sprockets	Chain & belt return systems	Frame & structure supports	Bearing supports	
Curves & tracks	Side guide solutions	Miscellaneous products	Equipment	

SYSTEM PLAST®



30100c

www.SystemPlastSmartGuide.com

12,7 mm (1/2") MODULAR BELTS

VERSIONS WITH POSITIONERS / RUBBER INSERT

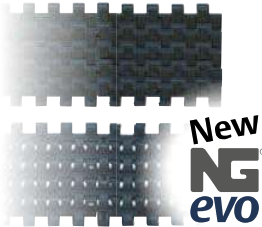
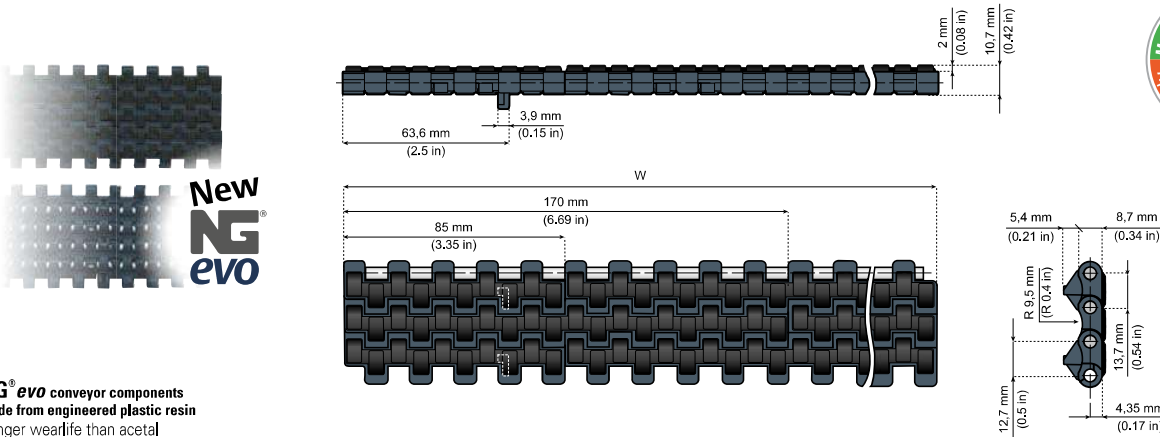

New NG evo

NG® evo conveyor components made from engineered plastic resin

- Longer wearlife than acetal
- Lower friction than acetal
- Good chemical resistance
- High abrasion resistance
- It meets the requirement for materials as stated by EC1935/2004 and FDA CFR21 norms for direct food contact
- Less dust than with acetal chains
- More.....

- Belt material:** grey blue colour
- Rubber material:** thermoplastic rubber, black colour, 50 shore A.
- Backflex radius:** 20 mm (0.8 in)
- Max load capacity:** 18000 N/m (1260 lbs/ft.)
- Pin material:** PBT (white)
- Standard length:**
 - width ≤ 340 mm (13.39 in): 3,048 m (10 ft.)
 - width > 340 mm (13.39 in) ≤ 1700 mm (66.93 in) : 1,524 m (5 ft.)
 - belt width > 1700 mm (66.93 in): on request

VG 2120-P
Insert every pitch

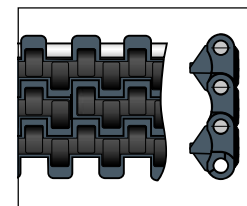

Weight:
9,7 Kg/m² (1.98 lbs/ft.²)

30160a

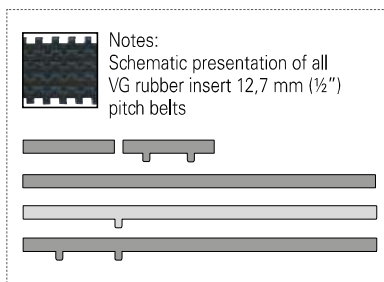

Other versions for 12,7 mm (1/2") belts:

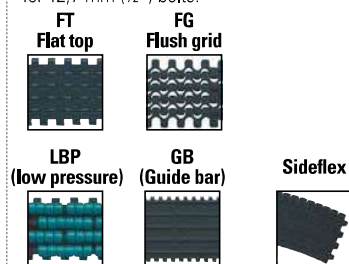

Information about this product is only available on our Smart Guide® website.

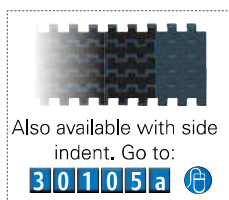

Standard material

NGE (GREY BLUE)

New Generation®

materials details:

73563a

TPR (BLACK)

Thermoplastic rubber

materials details:

73570a

WIDTH W		ITEM DESCRIPTION
mm	in	
85	3.35	NGE2120FT-P-M0085VG50
170	6.69	NGE2120FT-P-M0170VG50
255	10.04	NGE2120FT-P-M0255VG50
340	13.39	NGE2120FT-P-M0340VG50
425	16.73	NGE2120FT-P-M0425VG50
510	20.08	NGE2120FT-P-M0510VG50
595	23.43	NGE2120FT-P-M0595VG50
680	26.77	NGE2120FT-P-M0680VG50
765	30.12	NGE2120FT-P-M0765VG50
850	33.46	NGE2120FT-P-M0850VG50
935	36.81	NGE2120FT-P-M0935VG50
1020	40.16	NGE2120FT-P-M1020VG50
1105	43.50	NGE2120FT-P-M1105VG50
1190	46.85	NGE2120FT-P-M1190VG50
1275	50.20	NGE2120FT-P-M1275VG50
1360	53.54	NGE2120FT-P-M1360VG50
1445	56.89	NGE2120FT-P-M1445VG50
1530	60.24	NGE2120FT-P-M1530VG50
1615	63.58	NGE2120FT-P-M1615VG50
1700	66.93	NGE2120FT-P-M1700VG50
1785	70.28	NGE2120FT-P-M1785VG50
1870	73.62	NGE2120FT-P-M1870VG50
1955	76.97	NGE2120FT-P-M1955VG50
2040	80.31	NGE2120FT-P-M2040VG50

Other widths available on request.

Chains & sprockets	Wear strips	Side guide brackets & accessories	Levelers	Engineering manual
Modular belts & sprockets	Chain & belt return systems	Frame & structure supports	Bearing supports	
Curves & tracks	Side guide solutions	Miscellaneous products	Equipment	

30100d

www.SystemPlastSmartGuide.com

12,7 mm (½") MODULAR BELTS

VERSIONS WITH TWIN POSITIONERS / RUBBER INSERT

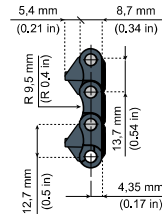
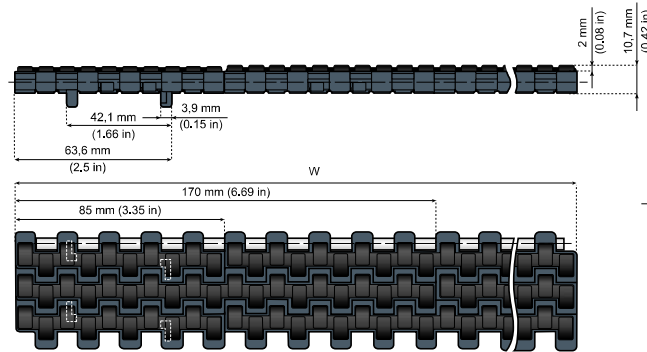
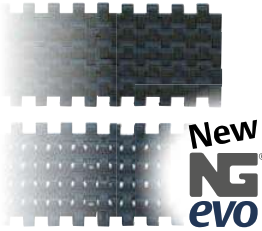

NG® evo conveyor components made from engineered plastic resin

- Longer wearlife than acetal
- Lower friction than acetal
- Good chemical resistance
- High abrasion resistance
- It meets the requirement for materials as stated by EC1935/2004 and FDA CFR21 norms for direct food contact
- Less dust than with acetal chains
- More.....

Belt material: grey blue colour

Rubber material: thermoplastic rubber, black colour, 50 shore A.

Backflex radius: 20 mm (0.8 in)

Max load capacity: 18000 N/m (1260 lbs/ft.)

Pin material: PBT (white)

Standard length:

width ≤ 340 mm (13.39 in): 3,048 m (10 ft.)

width > 340 mm (13.39 in) ≤ 1700 mm (66.93 in) : 1,524 m (5 ft.)

width > 1700 mm (66.93 in): on request

VG 2120-PT Insert every pitch

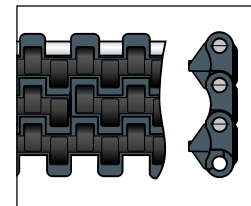

Weight:

9,7 Kg/m² (1.98 lbs/ft.²)

30160a

Notes:
Schematic presentation of all VG rubber insert 12,7 mm (½") pitch belts

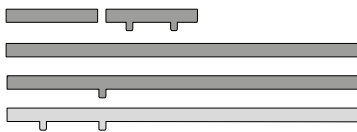

Other versions for 12,7 mm (½") belts:

FT
Flat top



FG
Flush grid



LBP
(low pressure)



GB
(Guide bar)



Sideflex



Information about this product is only available on our Smart Guide® website.

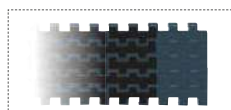

Also available with side indent. Go to:

30105a

Standard material

NGE (GREY BLUE)

New Generation®

materials details:

73563a

TPR (BLACK)

Thermoplastic rubber

materials details:

73570a

WIDTH W		ITEM DESCRIPTION
mm	in	
85	3.35	NGE2120FT-PT-M0085VG50
170	6.69	NGE2120FT-PT-M0170VG50
255	10.04	NGE2120FT-PT-M0255VG50
340	13.39	NGE2120FT-PT-M0340VG50
425	16.73	NGE2120FT-PT-M0425VG50
510	20.08	NGE2120FT-PT-M0510VG50
595	23.43	NGE2120FT-PT-M0595VG50
680	26.77	NGE2120FT-PT-M0680VG50
765	30.12	NGE2120FT-PT-M0765VG50
850	33.46	NGE2120FT-PT-M0850VG50
935	36.81	NGE2120FT-PT-M0935VG50
1020	40.16	NGE2120FT-PT-M1020VG50
1105	43.50	NGE2120FT-PT-M1105VG50
1190	46.85	NGE2120FT-PT-M1190VG50
1275	50.20	NGE2120FT-PT-M1275VG50
1360	53.54	NGE2120FT-PT-M1360VG50
1445	56.89	NGE2120FT-PT-M1445VG50
1530	60.24	NGE2120FT-PT-M1530VG50
1615	63.58	NGE2120FT-PT-M1615VG50
1700	66.93	NGE2120FT-PT-M1700VG50
1785	70.28	NGE2120FT-PT-M1785VG50
1870	73.62	NGE2120FT-PT-M1870VG50
1955	76.97	NGE2120FT-PT-M1955VG50
2040	80.31	NGE2120FT-PT-M2040VG50

Other widths available on request.

Chains & sprockets	Wear strips	Side guide brackets & accessories	Levelers	Engineering manual
Modular belts & sprockets	Chain & belt return systems	Frame & structure supports	Bearing supports	
Curves & tracks	Side guide solutions	Miscellaneous products	Equipment	

3 0 1 0 5 a

www.SystemPlastSmartGuide.com

12,7 mm (½") MODULAR BELTS

RUBBER INSERT EVERY PITCH WITH SIDE INDENT

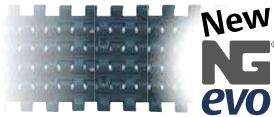
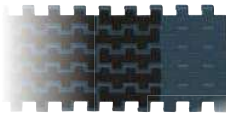

NG® evo conveyor components made from engineered plastic resin

- Longer wearlife than acetal
- Lower friction than acetal
- Good chemical resistance
- High abrasion resistance
- It meets the requirement for materials as stated by EC1935/2004 and FDA CFR21 norms for direct food contact
- Less dust than with acetal chains
- More.....

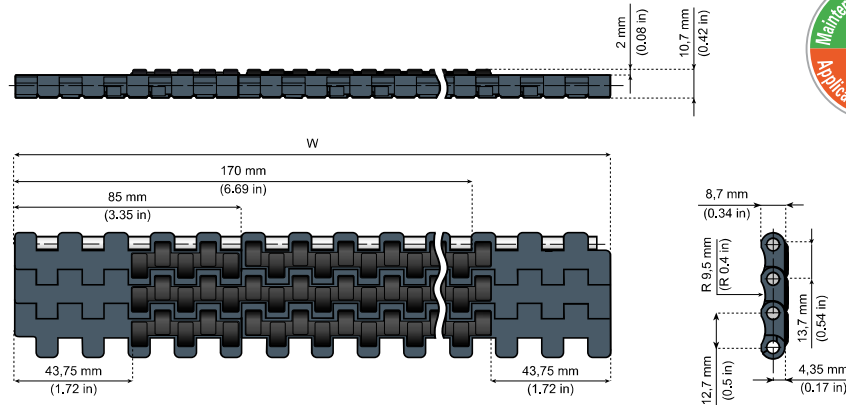

Belt material: grey blue colour

Rubber material: thermoplastic rubber, black colour, 50 shore A.

Backflex radius: 20 mm (0.8 in)

Max load capacity: 18000 N/m (1260 lbs/ft.)

Pin material: PBT (white)

Standard length:

- width ≤ 340 mm (13.39 in): 3,048 m (10 ft.)
- width > 340 mm (13.39 in) ≤ 1700 mm (66.93 in) : 1,524 m (5 ft.)
- width > 1700 mm (66.93 in): on request



Usually used on short conveyors with a Nose Bar to create extremely short transfers

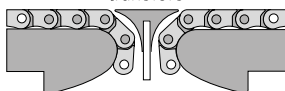

page code: **3 0 1 7 5 a**



Notes: Schematic presentation of all VG rubber insert 12,7 mm (½") pitch belts

Other versions for 12,7 mm (½") belts:

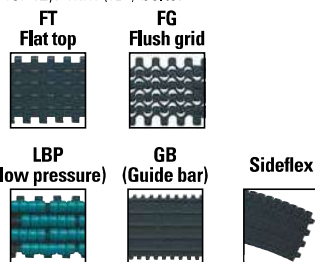

Information about this product is only available on our Smart Guide® website.

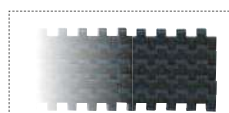

For full width rubber surface. Go to:

3 0 1 0 0 a

Standard material

NGE (GREY BLUE)

New Generation®

materials details: **7 3 5 6 3 a**

TPR (BLACK)

Thermoplastic rubber

materials details: **7 3 5 7 0 a**

VGS 2120 Insert every pitch

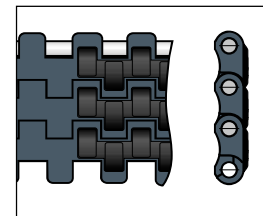

Weight:
9,7 Kg/m² (1.98 lbs/ft².)

WIDTH W		ITEM DESCRIPTION
mm	in	
255	10.04	NGE2120FT-M0255VGS50
340	13.39	NGE2120FT-M0340VGS50
425	16.73	NGE2120FT-M0425VGS50
510	20.08	NGE2120FT-M0510VGS50
595	23.43	NGE2120FT-M0595VGS50
680	26.77	NGE2120FT-M0680VGS50
765	30.12	NGE2120FT-M0765VGS50
850	33.46	NGE2120FT-M0850VGS50
935	36.81	NGE2120FT-M0935VGS50
1020	40.16	NGE2120FT-M1020VGS50
1105	43.50	NGE2120FT-M1105VGS50
1190	46.85	NGE2120FT-M1190VGS50
1275	50.20	NGE2120FT-M1275VGS50
1360	53.54	NGE2120FT-M1360VGS50
1445	56.89	NGE2120FT-M1445VGS50
1530	60.24	NGE2120FT-M1530VGS50
1615	63.58	NGE2120FT-M1615VGS50
1700	66.93	NGE2120FT-M1700VGS50
1785	70.28	NGE2120FT-M1785VGS50
1870	73.62	NGE2120FT-M1870VGS50
1955	76.97	NGE2120FT-M1955VGS50
2040	80.31	NGE2120FT-M2040VGS50

Other widths available on request.

Chains & sprockets	Wear strips	Side guide brackets & accessories	Levelers	Engineering manual
Modular belts & sprockets	Chain & belt return systems	Frame & structure supports	Bearing supports	
Curves & tracks	Side guide solutions	Miscellaneous products	Equipment	

SYSTEM PLAST®



3 0 1 1 0 a

12,7 mm (½") MODULAR BELTS 2120-LBP

www.SystemPlastSmartGuide.com

LOW NOISE ACCUMULATION ROLLERS

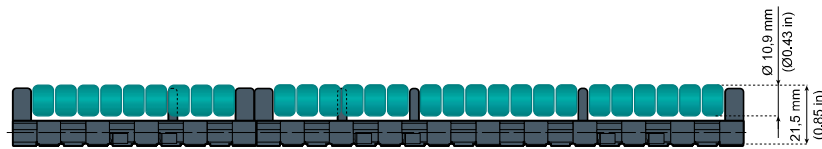

New NG evo

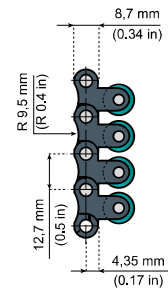
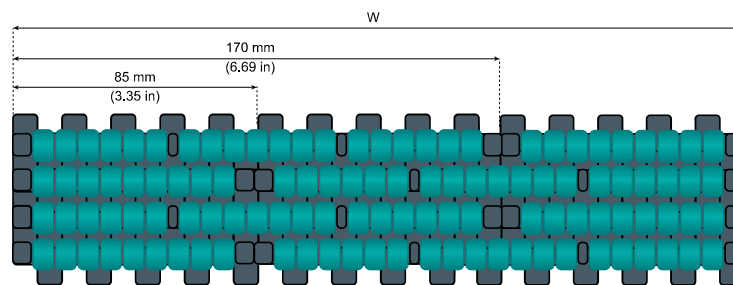

NG® evo conveyor components made from engineered plastic resin

- Longer wearlife than acetal
- Lower friction than acetal
- Good chemical resistance
- High abrasion resistance
- It meets the requirement for materials as stated by EC1935/2004 and FDA CFR21 norms for direct food contact
- Less dust than with acetal chains
- More.....

Backflex radius: 65 mm (2.56 in)

Max load capacity: 18000 N/m (1260 lbs/ft.)

Weight: 23,2 Kg/m² (4,73 lbs/ft².)

Pin material: PBT (white)

Roller shaft material: Stainless Steel AISI 304

Standard length:

width ≤ 340 mm (13.39 in): 1,524 m (5 ft.)

width > 340 mm (13.39 in) ≤ 935 mm (36.81 in): 0,762 m (0.03 in)

width > 935 mm (36.81 in): on request



Information about this product is only available on our Smart Guide® website.

Standard material

NGE (GREY BLUE)

New Generation®

materials details:

7 3 5 6 3 a



Usually used on short conveyors with a Nose Bar to create extremely short transfers

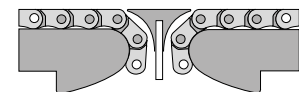

page code: **3 0 1 7 5 a**

3 0 1 6 0 a

Other versions for 12,7 mm (½") belts:

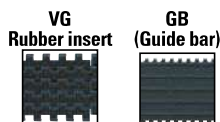
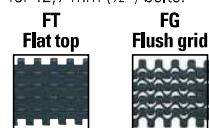

ROLLER GUIDE



For roller guide. Go to:

5 2 5 1 0 a

WIDTH W		ITEM DESCRIPTION
mm	in	
85	3.35	NGE2120LBP-M0085
170	6.69	NGE2120LBP-M0170
255	10.04	NGE2120LBP-M0255
340	13.39	NGE2120LBP-M0340
425	16.73	NGE2120LBP-M0425
510	20.08	NGE2120LBP-M0510
595	23.43	NGE2120LBP-M0595
680	26.77	NGE2120LBP-M0680
765	30.12	NGE2120LBP-M0765
850	33.46	NGE2120LBP-M0850
935	36.81	NGE2120LBP-M0935
1020	40.16	NGE2120LBP-M1020
1105	43.50	NGE2120LBP-M1105

Wider widths available upon request. LBP belts cannot be cut-to-width.

Chains & sprockets	Wear strips	Side guide brackets & accessories	Levelers	Engineering manual
Modular belts & sprockets	Chain & belt return systems	Frame & structure supports	Bearing supports	
Curves & tracks	Side guide solutions	Miscellaneous products	Equipment	

SYSTEM PLAST®



3 0 1 2 0 a

www.SystemPlastSmartGuide.com

12,7 mm (½") MODULAR BELTS 2120 GB

VERSION WITH GUIDE BAR EVERY PITCH FOR TRANSFER

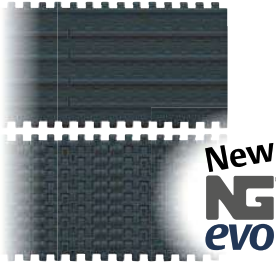

New NG evo

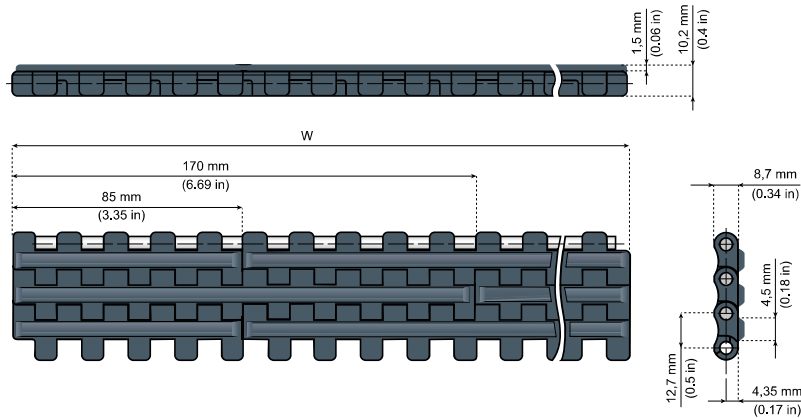

NG® evo conveyor components made from engineered plastic resin

- Longer wearlife than acetal
- Lower friction than acetal
- Good chemical resistance
- High abrasion resistance
- It meets the requirement for materials as stated by EC1935/2004 and FDA CFR21 norms for direct food contact
- Less dust than with acetal chains
- More.....

Belt material: grey blue colour

Backflex radius: 20 mm (0.79 in)

Max load capacity: 18000 N/m (1260 lbs/ft.)

Pin material: PBT (white)

Standard length:

- width ≤ 340 mm (13.39 in): 3,048 m (10 ft.)
- width > 340 mm (13.39 in) ≤ 1700 mm (66.93 in) : 1,524 m (5 ft.)
- width > 1700 mm (66.93 in): on request

Usually used on short conveyors with a Nose Bar to create extremely short transfers

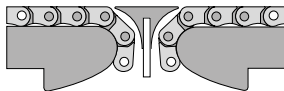

page code: **3 0 1 1 7 5 a**



Information about this product is only available on our Smart Guide® website.

Standard material

NGE (GREY BLUE)

New Generation®

materials details:

7 3 5 6 3 a

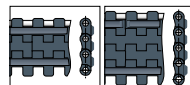

For insert every 2nd or 3th pitch, go to:

3 0 1 2 0 b

GB 2120 Guide bar on every pitch

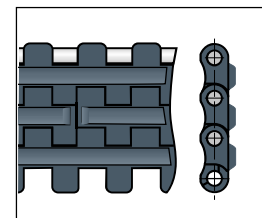

Weight:

10,4 Kg/m² (2.12 lbs/ft².)

Notes: Schematic presentation of all GB guide bar 12,7 mm (½") pitch belts



Other versions for 12,7 mm (½") belts:

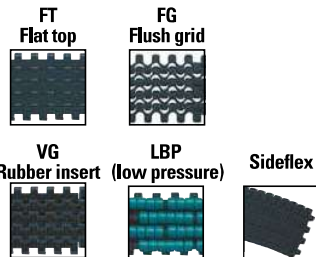

WIDTH W		ITEM DESCRIPTION
mm	in	
85	3.35	NGE2120FT-M0085GB
170	6.69	NGE2120FT-M0170GB
255	10.04	NGE2120FT-M0255GB
340	13.39	NGE2120FT-M0340GB
425	16.73	NGE2120FT-M0425GB
510	20.08	NGE2120FT-M0510GB
595	23.43	NGE2120FT-M0595GB
680	26.77	NGE2120FT-M0680GB
765	30.12	NGE2120FT-M0765GB
850	33.46	NGE2120FT-M0850GB
935	36.81	NGE2120FT-M0935GB
1020	40.16	NGE2120FT-M1020GB
1105	43.50	NGE2120FT-M1105GB
1190	46.85	NGE2120FT-M1190GB

Other widths available on request.

Chains & sprockets	Wear strips	Side guide brackets & accessories	Levelers	Engineering manual
Modular belts & sprockets	Chain & belt return systems	Frame & structure supports	Bearing supports	
Curves & tracks	Side guide solutions	Miscellaneous products	Equipment	

3 0 1 2 0 b

www.SystemPlastSmartGuide.com

12,7 mm (½") MODULAR BELTS 2120 GB

VERSION WITH GUIDE BAR ON 2nd & 3th PITCH FOR TRANSFER

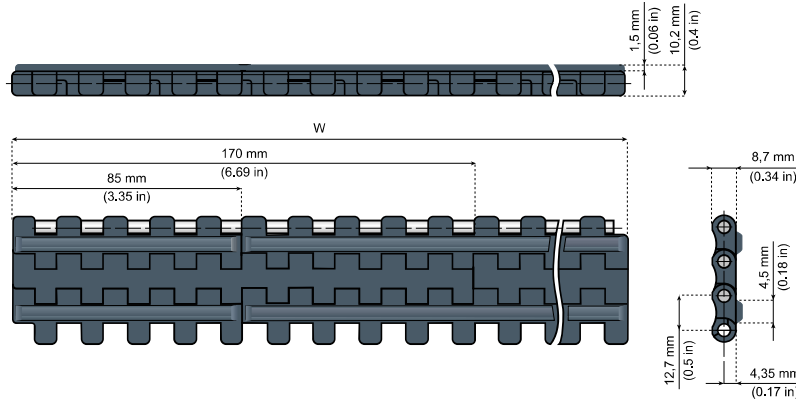
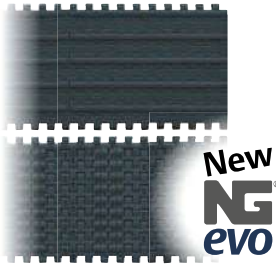

NG® evo conveyor components made from engineered plastic resin

- Longer wearlife than acetal
- Lower friction than acetal
- Good chemical resistance
- High abrasion resistance
- It meets the requirement for materials as stated by EC1935/2004 and FDA CFR21 norms for direct food contact
- Less dust than with acetal chains
- More.....

Belt material: grey blue colour

Backflex radius: 20 mm (0.79 in)

Max load capacity: 18000 N/m (1260 lbs/ft.)

Pin material: PBT (white)

Standard length:

- width ≤ 340 mm (13.39 in): 3,048 m (10 ft.)
- width > 340 mm (13.39 in) ≤ 1700 mm (66.93 in) : 1,524 m (5 ft.)
- width > 1700 mm (66.93 in): on request

Usually used on short conveyors with a Nose Bar to create extremely short transfers

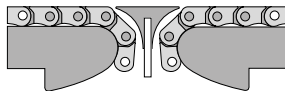

page code: **3 0 1 7 5 a**



3 0 1 6 0 a



Information about this product is only available on our Smart Guide® website.

Standard material

NGE (GREY BLUE)

New Generation®

materials details:

7 3 5 6 3 a

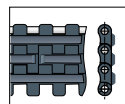

For every insert, go to:

3 0 1 2 0 a

GB2 2120
Guide bar
every 2nd pitch

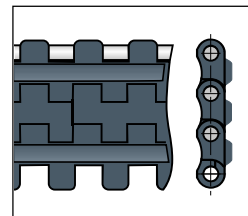

Weight:
10,4 Kg/m² (2.12 lbs/ft².)

GB3 2120
Guide bar
every 3th pitch

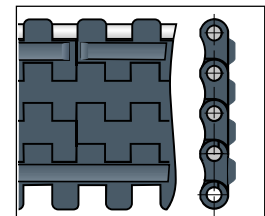

Weight:
9,9 Kg/m² (2.02 lbs/ft².)

Notes: Schematic presentation of all GB guide bar 12,7 mm (½") pitch belts



Other versions for 12,7 mm (½") belts:

FT
Flat top



FG
Flush grid



VG
Rubber insert



LBP
(low pressure)



Sideflex



WIDTH W		ITEM DESCRIPTION	ITEM DESCRIPTION
mm	in		
85	3.35	NGE2120FT-M0085GB-2	NGE2120FT-M0085GB-3
170	6.69	NGE2120FT-M0170GB-2	NGE2120FT-M0170GB-3
255	10.04	NGE2120FT-M0255GB-2	NGE2120FT-M0255GB-3
340	13.39	NGE2120FT-M0340GB-2	NGE2120FT-M0340GB-3
425	16.73	NGE2120FT-M0425GB-2	NGE2120FT-M0425GB-3
510	20.08	NGE2120FT-M0510GB-2	NGE2120FT-M0510GB-3
595	23.43	NGE2120FT-M0595GB-2	NGE2120FT-M0595GB-3
680	26.77	NGE2120FT-M0680GB-2	NGE2120FT-M0680GB-3
765	30.12	NGE2120FT-M0765GB-2	NGE2120FT-M0765GB-3
850	33.46	NGE2120FT-M0850GB-2	NGE2120FT-M0850GB-3
935	36.81	NGE2120FT-M0935GB-2	NGE2120FT-M0935GB-3
1020	40.16	NGE2120FT-M1020GB-2	NGE2120FT-M1020GB-3
1105	43.50	NGE2120FT-M1105GB-2	NGE2120FT-M1105GB-3
1190	46.85	NGE2120FT-M1190GB-2	NGE2120FT-M1190GB-3

Other widths available on request.

Chains & sprockets	Wear strips	Side guide brackets & accessories	Levelers	Engineering manual
Modular belts & sprockets	Chain & belt return systems	Frame & structure supports	Bearing supports	
Curves & tracks	Side guide solutions	Miscellaneous products	Equipment	

3 0 1 6 0 a

www.SystemPlastSmartGuide.com

DRIVE AND RETURN SPROCKETS

FOR BELTS 2120 - 2120M - 2121

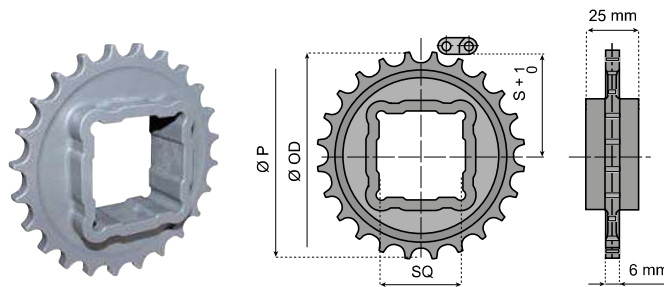

FOR 2120 - 2121-2122

MOLDED DRIVE SPROCKETS SQUARE BORE ONE PIECE - FLOATING		
z	∅ 30X30	∅ 40X40
	ITEM DESCRIPTION	
24	2120-24S30M-D	2120-24S40M-D

Material: reinforced polyamide (grey).

z	Ø OD mm	Ø P mm	S mm
24	97,3	96,5	44,14
28	113,3	112,5	52,15
36	145,4	144,6	68,28

Notes:

Sprockets with 'fixed' bores (standard split types) do not follow the expansion or contraction of a belt and therefore can be used only for belts widths up to 680 mm (27-in) and temperature differences of maximum 30°C (86°F).

For all other applications we recommend using floating sprockets. Sprockets that normally have a 'fixed' or 'tight' bore can be made 'floating' on request. In that case just add the letter P to the standard item description.

For example, code **2120-24R30M-DPS**



Sprockets with 'tight' bores (standard one piece types) can be a cost effective solution for many applications; but if the belt is wider than 680 mm and large temperature fluctuations (> 30°C - 86°F) occur, we recommend using the floating versions. 'Tight' and 'floating' bore sprockets are recommended to be kept in position with set collars or with help of the positioners of the belt.

New design 3 0 9 9 5 a

Features:

- New design with snap-assembly system included.
- Very high strength.
- Split versions: quick and easy replacement.
- Foolproof design.
- Excellent wear and chemical resistance.
- Recyclable.

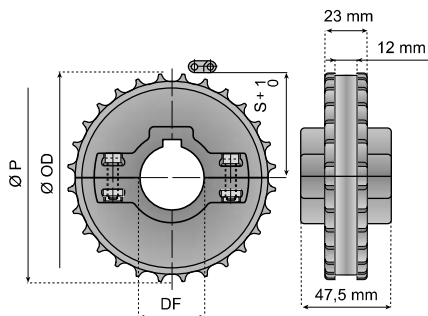

NOT SUITABLE FOR 2122 FG !

MOLDED DRIVE SPROCKETS - SPLIT FIXED			
z	∅ 30	∅ 35	∅ 40
	ITEM DESCRIPTION		
24	2120-24R30M-DS	2120-24R35M-DS	2120-24R40M-DS
28	2120-28R30M-DS	2120-28R35M-DS	2120-28R40M-DS
36	2120-36R30M-DS	-	2120-36R40M-DS
MOLDED RETURN SPROCKETS - SPLIT			
24	2120-24R30M-RS	2120-24R35M-RS	2120-24R40M-RS
28	2120-28R30M-RS	2120-28R35M-RS	2120-28R40M-RS
36	2120-36R30M-RS	-	2120-36R40M-RS

Material: reinforced polyamide (black), screws in stainless steel, nuts in nickel plated brass.



Information about this product is only available on our Smart Guide® website.



See also the sprockets and idler wheels:

3 0 1 6 0 b
3 0 1 6 0 c



See 12,7 mm (½") pitch belts:

3 0 0 2 0 a

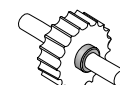

Set collars, go to:

5 4 6 3 0 a

Chains & sprockets	Wear strips	Side guide brackets & accessories	Levelers	Engineering manual
Modular belts & sprockets	Chain & belt return systems	Frame & structure supports	Bearing supports	
Curves & tracks	Side guide solutions	Miscellaneous products	Equipment	



Features:

- Very high strength.
- Split versions: quick and easy replacement.
- Foolproof design.
- Completely closed structure, easy to clean and to disinfect.
- Excellent wear and chemical resistance.
- Recyclable.

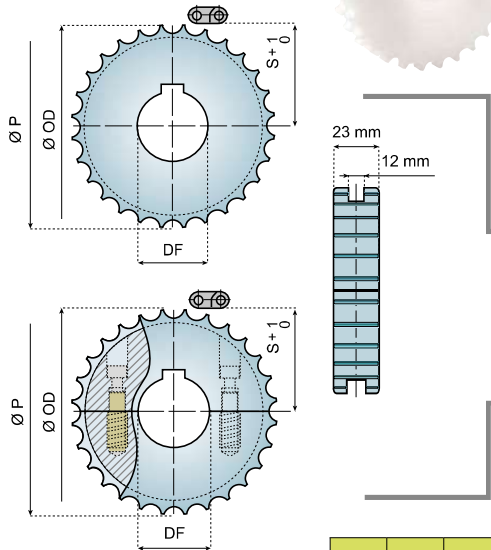

MACHINED DRIVE SPROCKETS - ONE PIECE TIGHT				
Z	Ø 25	Ø 30	Ø 35	Ø 40
ITEM DESCRIPTION				
14	2120-14R25M-DM	2120-14R30M-DM	-	-
16	2120-16R25M-DM	2120-16R30M-DM	-	-
20	2120-20R25M-DM	2120-20R30M-DM	2120-20R35M-DM	2120-20R40M-DM
24	2120-24R25M-DM	2120-24R30M-DM	2120-24R35M-DM	2120-24R40M-DM
MACHINED DRIVE SPROCKETS - SPLIT FIXED				
28	2120-28R25M-DMS	2120-28R30M-DMS	2120-28R35M-DMS	2120-28R40M-DMS
36	2120-36R25M-DMS	2120-36R30M-DMS	2120-36R35M-DMS	2120-36R40M-DMS
38	2120-38R25M-DMS	2120-38R30M-DMS	2120-38R35M-DMS	2120-38R40M-DMS
40	2120-40R25M-DMS	2120-40R30M-DMS	2120-40R35M-DMS	2120-40R40M-DMS

Material: polyamide (natural white), screws in stainless steel, bushings in brass.

Notes:

Sprockets with 'fixed' bores (standard split types) do not follow the expansion or contraction of a belt and therefore can be used only for belts widths up to 680 mm (27-in) and temperature differences of maximum 30°C (86°F).

For all other applications we recommend using floating sprockets. Sprockets that normally have a 'fixed' or 'tight' bore can be made 'floating' on request. In that case just add the letter P to the standard item description. For example, code **2120-14R25M-DPS**

Sprockets with 'tight' bores (standard one piece types) can be a cost effective solution for many applications, but if the belt is wider than 680 mm (27-in) and large temperature fluctuations (> 30°C - 86°F) occur, we recommend using the floating versions. 'Tight' and 'floating' bore sprockets are recommended to be kept in position with set collars or with help of the positioners of the belt.

Z	Ø OD mm	Ø P mm	S mm
14	56,4	56,6	24,17
16	64,5	64,6	28,15
20	80,4	80,5	36,14
24	97,3	96,5	44,14
28	113,3	112,5	52,15
36	145,4	144,6	68,28
38	153,9	152,6	72,28
40	161,9	160,6	76,30

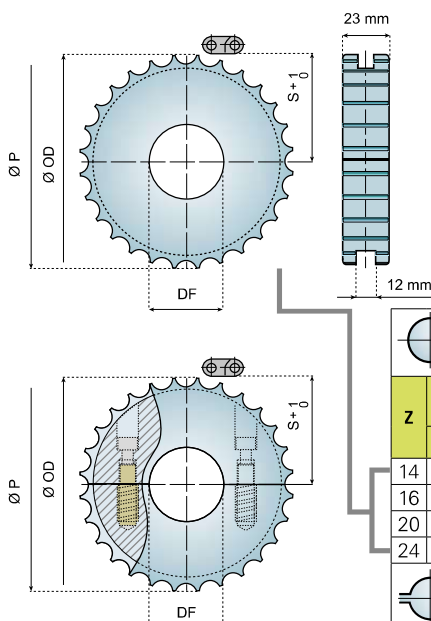

MACHINED RETURN SPROCKETS - ONE PIECE					
Z	Ø 18* (R18M) Ø 23* (R23M)	Ø 25	Ø 30	Ø 35	Ø 40
ITEM DESCRIPTION					
14	2120-14R18M-RM	2120-14R25M-RM	2120-14R30M-RM	-	-
16	2120-16R18M-RM	2120-16R25M-RM	2120-16R30M-RM	-	-
20	2120-20R18M-RM	2120-20R25M-RM	2120-20R30M-RM	2120-20R35M-RM	2120-20R40M-RM
24	2120-24R18M-RM	2120-24R25M-RM	2120-24R30M-RM	2120-24R35M-RM	2120-24R40M-RM
MACHINED RETURN SPROCKETS - SPLIT					
28	2120-28R23M-RMS	2120-28R25M-RMS	2120-28R30M-RMS	2120-28R35M-RMS	2120-28R40M-RMS
36	2120-36R23M-RMS	2120-36R25M-RMS	2120-36R30M-RMS	2120-36R35M-RMS	2120-36R40M-RMS
38	2120-38R23M-RMS	2120-38R25M-RMS	2120-38R30M-RMS	2120-38R35M-RMS	2120-38R40M-RMS
40	2120-40R23M-RMS	2120-40R25M-RMS	2120-40R30M-RMS	2120-40R35M-RMS	2120-40R40M-RMS

Material: polyamide (natural white), screws in stainless steel, bushings in brass. *Plain bore

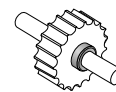

Set collars, go to:

54630a



Information about this product is only available on our Smart Guide® website.



See also the sprockets and idler wheels:

30160a

30160c



See 12,7 mm (½") pitch belts:

30020a

Chains & sprockets	Wear strips	Side guide brackets & accessories	Levelers	Engineering manual
Modular belts & sprockets	Chain & belt return systems	Frame & structure supports	Bearing supports	
Curves & tracks	Side guide solutions	Miscellaneous products	Equipment	

3 0 1 6 0 c

www.SystemPlastSmartGuide.com

DRIVE SPROCKETS

FOR BELTS 2120 - 2120M - 2121



New design

3 0 9 9 5 a



Features:

- New design with snap-assembly system included.
- Very high strength.
- Split versions: quick and easy replacement.
- Foolproof design.
- Excellent wear and chemical resistance.
- Recyclable.

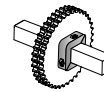

Set collars, go to:

5 4 6 3 0 a



See 12,7 mm (1/2") pitch belts:

3 0 0 2 0 a

See also the sprockets and idler wheels:

3 0 1 6 0 a

3 0 1 6 0 b

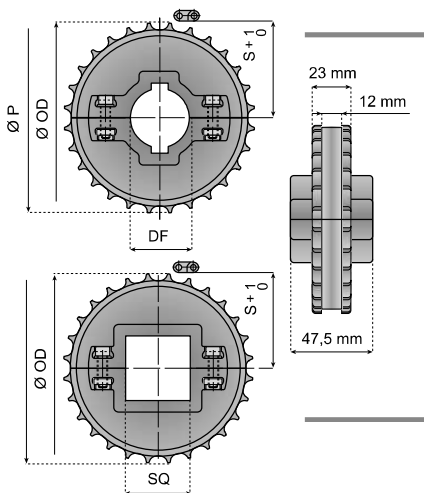

MOLDED DRIVE SPROCKETS - SPLIT DOUBLE KEYWAY - FLOATING

Z	Ø 30	Ø 35	Ø 40
	ITEM DESCRIPTION		
28	2120-28R30M-DPS-K2	2120-28R35M-DPS-K2	2120-28R40M-DPS-K2
36	2120-36R30M-DPS-K2	-	2120-36R40M-DPS-K2



MOLDED DRIVE SPROCKETS SQUARE BORE - SPLIT FLOATING

Z	Ø 40X40		
24	-	-	-
28	-	-	2120-28S40M-DS
36	-	-	2120-36S40M-DS

Material: reinforced polyamide (black), screws in stainless steel, nuts in nickel plated brass.

New design

3 0 9 9 0 a



Features:

- Very high strength.
- Split versions: quick and easy replacement.
- Foolproof design.
- Completely closed structure, easy to clean and to disinfect.
- Excellent wear and chemical resistance.
- Recyclable.

Z	Ø OD mm	Ø P mm	S mm
16	64,5	64,6	28,15
20	80,4	80,5	36,14
24	97,3	96,5	44,14
28	113,3	112,5	52,15
36	145,4	144,6	68,28
38	153,9	152,6	72,28

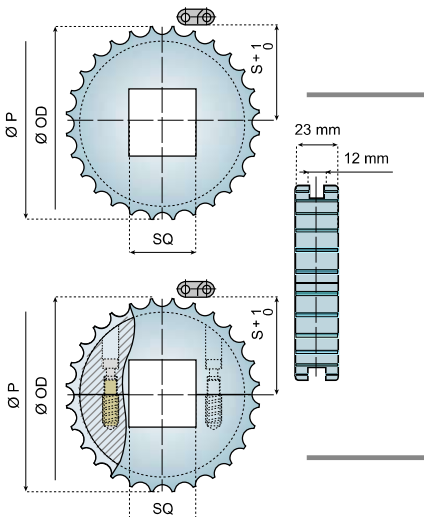

MACHINED DRIVE SPROCKETS SQUARE BORE - ONE PIECE FLOATING

Z	Ø 30X30	Ø 35X35	Ø 40X40	Ø 60X60
	ITEM DESCRIPTION			
16	2120-16S30M-DM	-	-	-
20	2120-20S30M-DM	2120-20S35M-DM	-	-
24	2120-24S30M-DM	-	2120-24S40M-DM	-



MACHINED DRIVE SPROCKETS SQUARE BORE - SPLIT FLOATING

28	2120-28S30M-DMS	-	2120-28S40M-DMS	-
36	2120-36S30M-DMS	-	2120-36S40M-DMS	2120-36S60M-DMS
38	2120-38S30M-DMS	-	2120-38S40M-DMS	2120-38S60M-DMS

Material: polyamide (natural white), screws in stainless steel, bushings in brass.

Chains & sprockets	Wear strips	Side guide brackets & accessories	Levelers	Engineering manual
Modular belts & sprockets	Chain & belt return systems	Frame & structure supports	Bearing supports	
Curves & tracks	Side guide solutions	Miscellaneous products	Equipment	

3 0 1 6 5 a

www.SystemPlastSmartGuide.com

DRIVE AND RETURN SPROCKETS

FOR BELT 2124

Item descriptions for drive sprockets are manufactured for a tight fit on the shaft.

Drive sprockets capable of floating freely on the shaft, just add the letter "P" (=plus) to the existing Item description. For example, code

2124-16R25M-DPMS



New design

3 0 9 9 0 a

Features:

- Very high strength.
- Split versions: quick and easy replacement.
- Foolproof design.
- Completely closed structure, easy to clean and to disinfect.
- Excellent wear and chemical resistance.
- Recyclable.

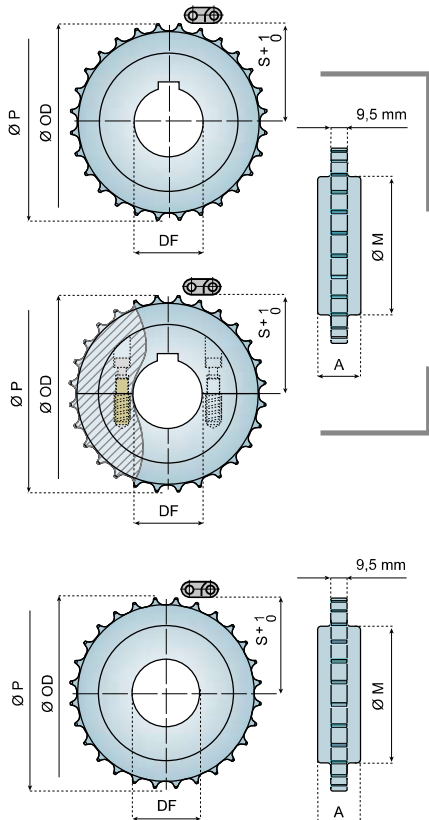

MACHINED DRIVE SPROCKETS - ONE PIECE TIGHT				
A = 25				
Z	Ø 25	Ø 30	Ø 35	Ø 40
ITEM DESCRIPTION				
16	2124-16R25M-DM	2124-16R30M-DM	-	-
24	2124-24R25M-DM	2124-24R30M-DM	2124-24R35M-DM	2124-24R40M-DM
MACHINED DRIVE SPROCKETS - SPLIT FIXED				
A = 34				
28	2124-28R25M-DMS	2124-28R30M-DMS	2124-28R35M-DMS	2124-28R40M-DMS
36	2124-36R25M-DMS	2124-36R30M-DMS	2124-36R35M-DMS	2124-36R40M-DMS

Material: polyamide (natural white), screws in stainless steel, bushings in brass.

Z	Ø OD mm	Ø P mm	Ø M mm	S mm
16	63,5	64,6	43	28,2
24	97,3	96,5	65	44,3
28	113,9	112,5	92	52,4
36	146	144,6	105	68,5

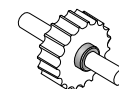

Set collars, go to:

5 4 6 3 0 a



Information about this product is only available on our Smart Guide® website.

See belts 12,7 mm (½"): 3 0 0 3 0 a, 3 0 0 3 0 b, 3 0 0 9 0 a



MACHINED RETURN SPROCKETS - ONE PIECE					
A = 25					
Z	Ø 18* (R18M) Ø 23* (R23M)	Ø 25	Ø 30	Ø 35	Ø 40
ITEM DESCRIPTION					
16	2124-16R18M-RM	2124-16R25M-RM	2124-16R30M-RM	-	-
24	2124-24R18M-RM	2124-24R25M-RM	2124-24R30M-RM	2124-24R35M-RM	2124-24R40M-RM
MACHINED RETURN SPROCKETS - SPLIT					
A = 34					
28	2124-28R23M-RMS	2124-28R25M-RMS	2124-28R30M-RMS	2124-28R35M-RMS	2124-28R40M-RMS
36	2124-36R23M-RMS	2124-36R25M-RMS	2124-36R30M-RMS	2124-36R35M-RMS	2124-36R40M-RMS

Material: polyamide (natural white), screws in stainless steel, bushings in brass. *Plain bore

Chains & sprockets	Wear strips	Side guide brackets & accessories	Levelers	Engineering manual
Modular belts & sprockets	Chain & belt return systems	Frame & structure supports	Bearing supports	
Curves & tracks	Side guide solutions	Miscellaneous products	Equipment	

3 0 1 6 6 a

www.SystemPlastSmartGuide.com

DRIVE AND RETURN SPROCKETS

FOR BELT 2122



Also available:
molded monoblock
sprockets 24 teeth
with square bore.
Go to:

3 0 1 6 0 a

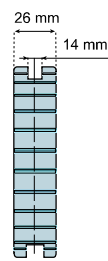
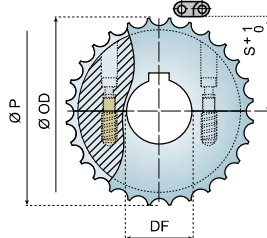
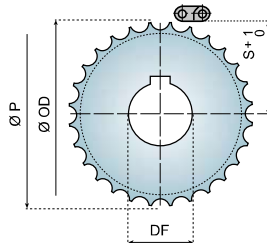

MACHINED DRIVE SPROCKETS - ONE PIECE TIGHT			
Z	Ø 25	Ø 30	Ø 40
ITEM DESCRIPTION			
14	2122-14R25M-DM	2122-14R30M-DM	-
20	2122-20R25M-DM	2122-20R30M-DM	-
24	2122-24R25M-DM	2122-24R30M-DM	-
MACHINED DRIVE SPROCKETS - SPLIT FIXED			
28	2122-28R25M-DMS	2122-28R30M-DMS	2122-28R40M-DMS
38	2122-38R25M-DMS	2122-38R30M-DMS	2122-38R40M-DMS

Material: polyamide (natural white), screws in stainless steel, bushings in brass.

Notes:

Sprockets with 'fixed' bores (standard split types) do not follow the expansion or contraction of a belt and therefore can be used only for belts widths up to 680 mm (27-in) and temperature differences of maximum 30°C (86°F).

For all other applications we recommend using floating sprockets. Sprockets that normally have a 'fixed' or 'tight' bore can be made 'floating' on request. In that case just add the letter P to the standard item description.

For example, code **2122-14R25M-DPS**

Sprockets with 'tight' bores (standard one piece types) can be a cost effective solution for many applications, but if the belt is wider than 680 mm (27-in) and large temperature fluctuations (> 30°C - 86°F) occur, we recommend using the floating versions. 'Tight' and 'floating' bore sprockets are recommended to be kept in position with set collars or with help of the positioners of the belt.

Z	Ø OD mm	Ø P mm	S mm
14	56,4	56,6	24,3
20	80,4	80,6	36,3
24	98,4	96,5	44,3
28	114,4	112,5	52,4
38	154,5	152,6	72,6

New design

3 0 9 9 0 a

Features:

- Very high strength.
- Split versions: quick and easy replacement.
- Foolproof design.
- Completely closed structure, easy to clean and to disinfect.
- Excellent wear and chemical resistance.
- Recyclable.



Information about this product is only available on our Smart Guide® website.

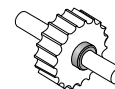

Set collars, go to:

5 4 6 3 0 a



See belts 2122:

3 0 0 7 3 a

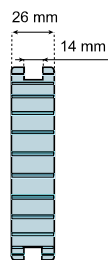
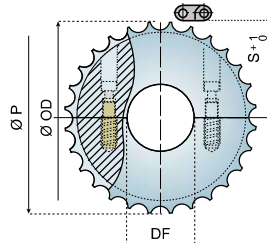
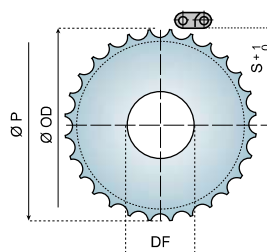

MACHINED RETURN SPROCKETS - ONE PIECE				
Z	Ø 18* (R18M) Ø 23* (R23M)	Ø 25	Ø 30	Ø 40
ITEM DESCRIPTION				
14	2122-14R18M-RM	2122-14R25M-RM	2122-14R30M-RM	-
20	2122-20R18M-RM	2122-20R25M-RM	2122-20R30M-RM	-
24	2122-24R18M-RM	2122-24R25M-RM	2122-24R30M-RM	-
MACHINED RETURN SPROCKETS - SPLIT				
28	2122-28R23M-RMS	2122-28R25M-RMS	2122-28R30M-RMS	2122-28R40M-RMS
38	2122-38R23M-RMS	2122-38R25M-RMS	2122-38R30M-RMS	2122-38R40M-RMS

Material: polyamide (natural white), screws in stainless steel, bushings in brass. *Plain bore

Chains & sprockets	Wear strips	Side guide brackets & accessories	Levelers	Engineering manual
Modular belts & sprockets	Chain & belt return systems	Frame & structure supports	Bearing supports	
Curves & tracks	Side guide solutions	Miscellaneous products	Equipment	

3 0 1 9 0 a

INDEX MODULAR BELTS

www.SystemPlastSmartGuide.com

19,05 mm (3/4") PITCH - THICKNESS: 8,7 mm (0.34 in)

FLAT TOP VERSION - 2190 FT



3 0 2 1 0 a



3 0 2 0 0 a

FLAT TOP VERSION WITH TRANSFER WING - 2190 FT



3 0 2 1 5 a

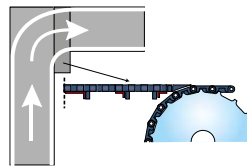

FLUSH GRID VERSION - 2190 FG

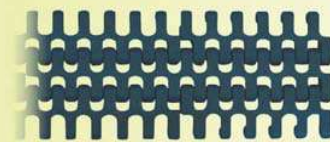

3 0 2 3 0 a

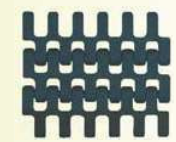

3 0 2 2 0 a



Information about this product is only available on our Smart Guide® website.

Chains & sprockets	Wear strips	Side guide brackets & accessories	Levelers	Engineering manual
Modular belts & sprockets	Chain & belt return systems	Frame & structure supports	Bearing supports	
Curves & tracks	Side guide solutions	Miscellaneous products	Equipment	

30200a

19,05 mm (3/4") MODULAR BELTS 2190

www.SystemPlastSmartGuide.com

FLAT TOP VERSION



NG® evo conveyor components made from engineered plastic resin
 Longer wearlife than acetal
 Lower friction than acetal
 Good chemical resistance
 High abrasion resistance
 It meets the requirement for materials as stated by EC1935/2004 and FDA CFR21 norms for direct food contact
 Less dust than with acetal chains
 More.....

SINGLE TRACK

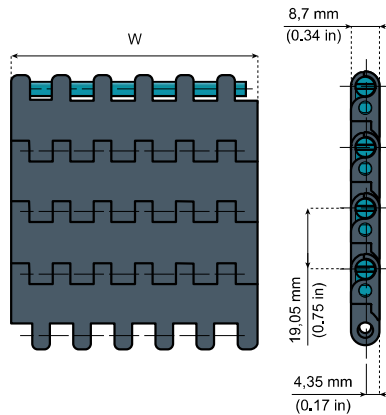

Standard material

NGE (GREY BLUE)

New Generation®

materials details:

73563a

ITEM DESCRIPTION	MATERIAL	WIDTH W		PITCH P		BACKFLEX RADIUS		MAX LOAD CAPACITY		WEIGHT	
		mm	in	mm	in	mm	in	N	lbs	Kg/m	lbs/ft.
NGE2190FT-K300	NGE Grey Blue	76,2	3	19,05	0,75	20	0,79	2070	460	0,6	0,4
NGE2190FT-K325		82,6	3,25					2250	500	0,6	0,4
NGE2190FT-K450		114,3	4,5					3060	680	0,8	0,54
NGE2190FT-K600		152,4	6					4150	910	1,1	0,74
NGE2190FT-K750		190,5	7,5					5150	1140	1,4	0,94

Standard length: 160 pitches (3,048 m - 10 ft.)

SINGLE TRACK WITH POSITIONER

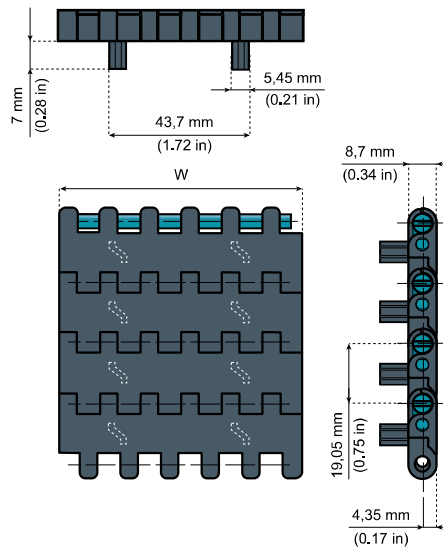

New
NG evo

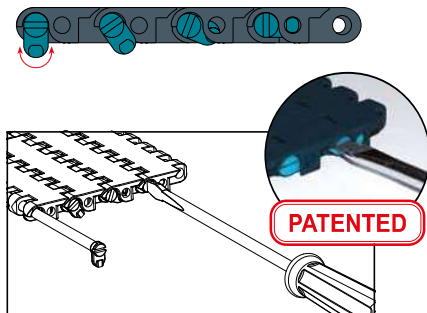

Pin material: PBT (water blue)

ITEM DESCRIPTION	MATERIAL	WIDTH W		PITCH P		BACKFLEX RADIUS		MAX LOAD CAPACITY		WEIGHT	
		mm	in	mm	in	mm	in	N	lbs	Kg/m	lbs/ft.
NGE2190FT-PT-K300	NGE Grey Blue	76,2	3	19,05	0,75	20	0,79	2070	460	0,6	0,4
NGE2190FT-PT-K325		82,6	3,25					2250	500	0,6	0,4
NGE2190FT-PT-K450		114,3	4,5					3060	680	0,8	0,54
NGE2190FT-PT-K600		152,4	6					4150	910	1,1	0,74
NGE2190FT-PT-K750		190,5	7,5					5150	1140	1,4	0,94

Standard length: 160 pitches (3,048 m - 10 ft.)

Other version for 19,05 mm (3/4") belts:

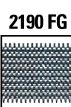

Notes:
Schematic presentation of all flat top 19,05 mm (3/4") pitch belts

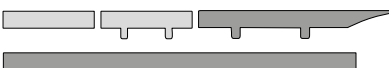

30235a



Information about this product is only available on our Smart Guide® website.

Chains & sprockets	Wear strips	Side guide brackets & accessories	Levelers	Engineering manual
Modular belts & sprockets	Chain & belt return systems	Frame & structure supports	Bearing supports	
Curves & tracks	Side guide solutions	Miscellaneous products	Equipment	

3 0 2 1 0 a

19,05 mm (3/4") MODULAR BELTS 2190

www.SystemPlastSmartGuide.com

FLAT TOP VERSION

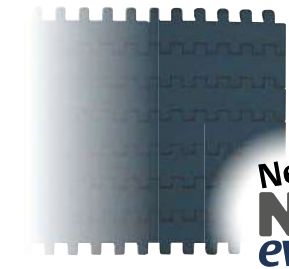

New NG evo

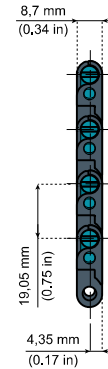
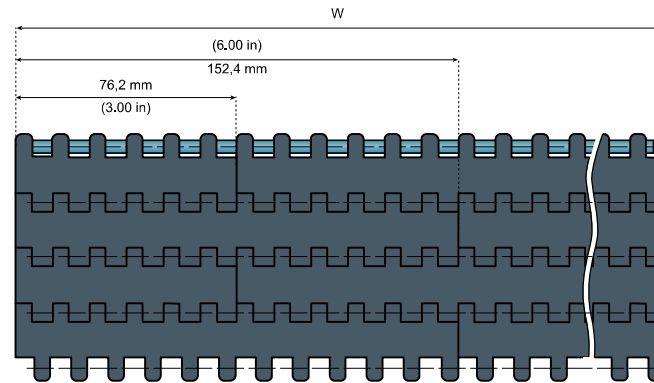

NG® evo conveyor components made from engineered plastic resin

- Longer wearlife than acetal
- Lower friction than acetal
- Good chemical resistance
- High abrasion resistance
- It meets the requirement for materials as stated by EC1935/2004 and FDA CFR21 norms for direct food contact
- Less dust than with acetal chains
- More.....

Backflex radius: 20 mm (0.79 in)

Max load capacity: 27000 N/m (1800 lbs/ft.)

Weight: 8,2 Kg/m² (1.67 lbs/ft².)

Pin material: PBT (water blue)

Standard length:

width ≤ 15 in: 3,048 m (10 ft.)

width > 15 in ≤ 66 in: 1,524 m (5 ft.)

width > 66 in: on request

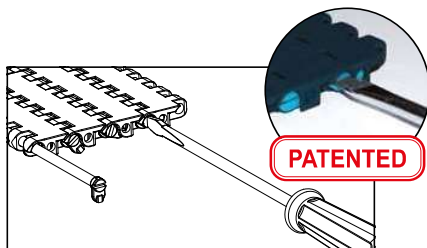

Standard material

NGE (GREY BLUE)

New Generation®

materials details:

7 3 5 6 3 a

Other version for 19,05 mm (3/4") belts:

2190 FG



Notes:
Schematic presentation of all flat top 19,05 mm (3/4") pitch belts

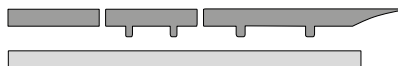

Information about this product is only available on our Smart Guide® website.



3 0 2 3 5 a

WIDTH W		ITEM DESCRIPTION
mm	in	
76	3.00	Go to: 3 0 2 0 0 a
152	6.00	
229	9.00	NGE2190FT-K900
305	12.00	NGE2190FT-K1200
381	15.00	NGE2190FT-K1500
457	18.00	NGE2190FT-K1800
533	21.00	NGE2190FT-K2100
610	24.00	NGE2190FT-K2400
686	27.00	NGE2190FT-K2700
762	30.00	NGE2190FT-K3000
838	33.00	NGE2190FT-K3300
914	36.00	NGE2190FT-K3600
991	39.00	NGE2190FT-K3900
1067	42.00	NGE2190FT-K4200
1143	45.00	NGE2190FT-K4500
1219	48.00	NGE2190FT-K4800
1295	51.00	NGE2190FT-K5100
1372	54.00	NGE2190FT-K5400
1448	57.00	NGE2190FT-K5700
1524	60.00	NGE2190FT-K6000
1600	63.00	NGE2190FT-K6300
1676	66.00	NGE2190FT-K6600
1753	69.00	NGE2190FT-K6900
1829	72.00	NGE2190FT-K7200
1905	75.00	NGE2190FT-K7500
1981	78.00	NGE2190FT-K7800
2057	81.00	NGE2190FT-K8100
2134	84.00	NGE2190FT-K8400
2210	87.00	NGE2190FT-K8700
2286	90.00	NGE2190FT-K9000

Other widths available on request.

Chains & sprockets	Wear strips	Side guide brackets & accessories	Levelers	Engineering manual
Modular belts & sprockets	Chain & belt return systems	Frame & structure supports	Bearing supports	
Curves & tracks	Side guide solutions	Miscellaneous products	Equipment	

30215a

SINGLE TRACK 19,05 mm (3/4") 2190 WITH TRANSFER WING

www.SystemPlastSmartGuide.com

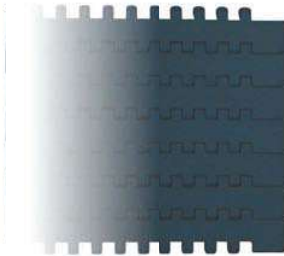

NG® *evo* conveyor components made from engineered plastic resin

Longer wearlife than acetal
 Lower friction than acetal
 Good chemical resistance
 High abrasion resistance
 It meets the requirement for materials as stated by EC1935/2004 and FDA CFR21 norms for direct food contact
 Less dust than with acetal chains
 More.....

Backflex radius: 20 mm (0,79 in)

Max load capacity:

K480T: 3300N (730lbs)

K510T: 3500N (780lbs)

Weight: 1,2 Kg/m (0,85 lbs/ft)

Pin material: PBT (water blue)

Standard length: 3,048 m (10ft)

Standard material

NGE (GREY BLUE)

New Generation®

materials details:

73563a

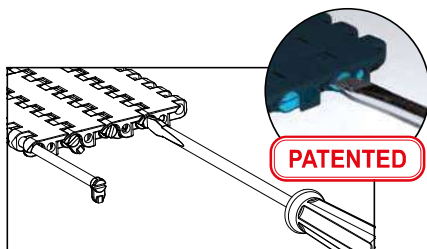

VERSION 4.8 INCHES (TOTAL WIDTH 6 INCHES)

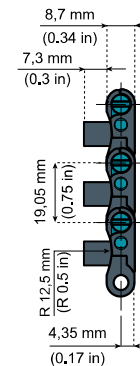
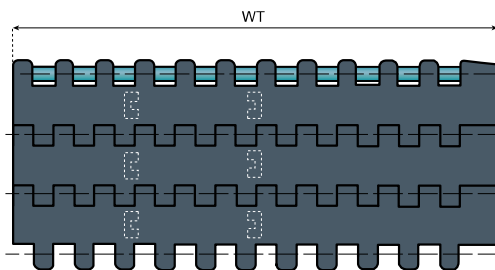
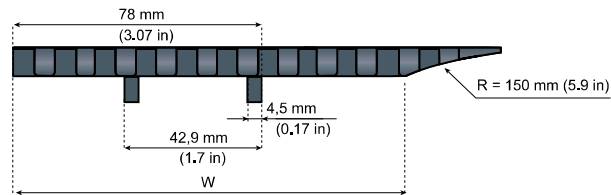

VERSION 5.1 INCHES (TOTAL WIDTH 6.3 INCHES)

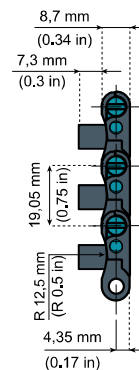
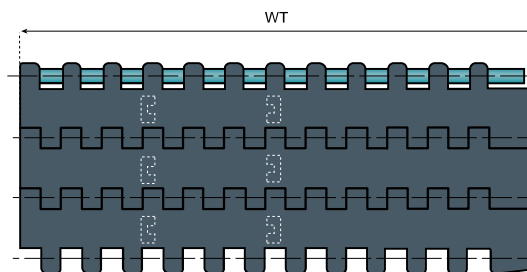
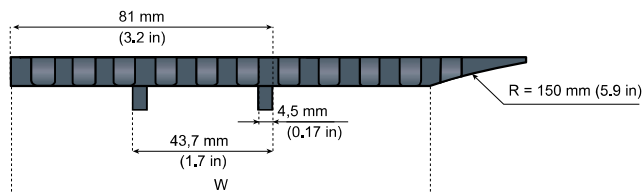

WIDTH W		WIDTH WT		ITEM DESCRIPTION
mm	in	mm	in	
122	4.8	152,4	6.0	NGE2190FT-PT-K480T
130	5.1	160,0	6.3	NGE2190FT-PT-K510T

Other version for 19,05 mm (3/4") belts:

2190 FG



Notes:
 Schematic presentation of all flat top 19,05 mm (3/4") pitch belts

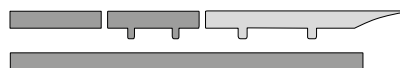

30235a

Information about this product is only available on our Smart Guide® website.

Chains & sprockets	Wear strips	Side guide brackets & accessories	Levelers	Engineering manual
Modular belts & sprockets	Chain & belt return systems	Frame & structure supports	Bearing supports	
Curves & tracks	Side guide solutions	Miscellaneous products	Equipment	

30220a

19,05 mm (3/4") MODULAR BELTS 2190

www.SystemPlastSmartGuide.com

FLUSH GRID VERSION



NG® evo conveyor components made from engineered plastic resin
 Longer wearlife than acetal
 Lower friction than acetal
 Good chemical resistance
 High abrasion resistance
 It meets the requirement for materials as stated by EC1935/2004 and FDA CFR21 norms for direct food contact
 Less dust than with acetal chains
 More.....

SINGLE TRACK

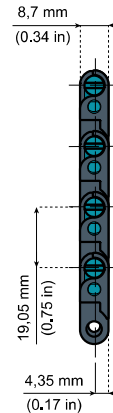
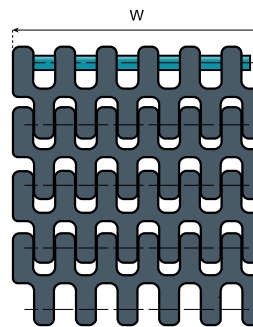

Standard material

NGE (GREY BLUE)

New Generation®

materials details:

73563a

Pin material: PBT (water blue) Open surface: 19%

ITEM DESCRIPTION	MATERIAL	WIDTH W		PITCH P		BACKFLEX RADIUS		MAX LOAD CAPACITY		WEIGHT	
		mm	in	mm	in	mm	in	N	lbs	Kg/m	lbs/ft.
NGE2190FG-K300	NGE Grey Blue	76,2	3	19,05	0,75	20	0,79	2070	460	0,5	0,34
NGE2190FG-K325		82,6	3,25					2250	500	0,5	0,34
NGE2190FG-K450		114,3	4,5					3060	680	0,7	0,47
NGE2190FG-K600		152,4	6					4150	910	1	0,67
NGE2190FG-K750		190,5	7,5					5150	1140	1,2	0,81

Standard length: 160 pitches (3,048 m - 10 ft.)

SINGLE TRACK WITH POSITIONER

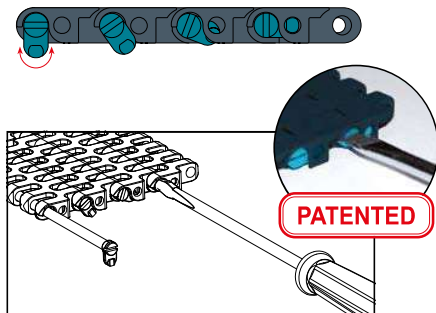
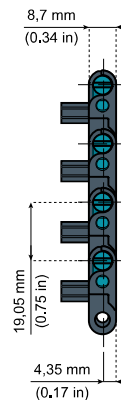
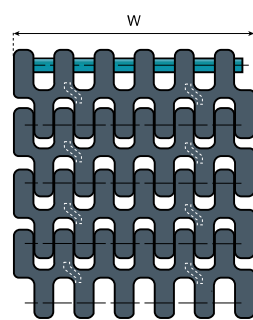
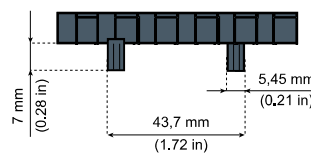

PATENTED

Pin material: PBT (water blue) Open surface: 19%

ITEM DESCRIPTION	MATERIAL	WIDTH W		PITCH P		BACKFLEX RADIUS		MAX LOAD CAPACITY		WEIGHT	
		mm	in	mm	in	mm	in	N	lbs	Kg/m	lbs/ft.
NGE2190FG-PT-K300	NGE Grey Blue	76,2	3	19,05	0,75	20	0,79	2070	460	0,5	0,34
NGE2190FG-PT-K325		82,6	3,25					2250	500	0,5	0,34
NGE2190FG-PT-K450		114,3	4,5					3060	680	0,7	0,47
NGE2190FG-PT-K600		152,4	6					4150	910	1	0,67
NGE2190FG-PT-K750		190,5	7,5					5150	1140	1,2	0,81

Standard length: 160 pitches (3,048 m - 10 ft.)

Other version for 19,05 mm (3/4") belts:

2190 FT



Notes:
Schematic presentation of all flat top 19,05 mm (3/4") pitch belts



30235a



Information about this product is only available on our Smart Guide® website.



Chains & sprockets	Wear strips	Side guide brackets & accessories	Levelers	Engineering manual
Modular belts & sprockets	Chain & belt return systems	Frame & structure supports	Bearing supports	
Curves & tracks	Side guide solutions	Miscellaneous products	Equipment	

3 0 2 3 0 a

19,05 mm (3/4") MODULAR BELTS 2190

www.SystemPlastSmartGuide.com

FLUSH GRID VERSION



New NG evo

NG® evo conveyor components made from engineered plastic resin

- Longer wearlife than acetal
- Lower friction than acetal
- Good chemical resistance
- High abrasion resistance
- It meets the requirement for materials as stated by EC1935/2004 and FDA CFR21 norms for direct food contact
- Less dust than with acetal chains
- More.....

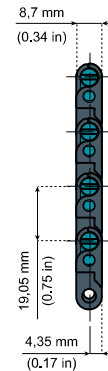
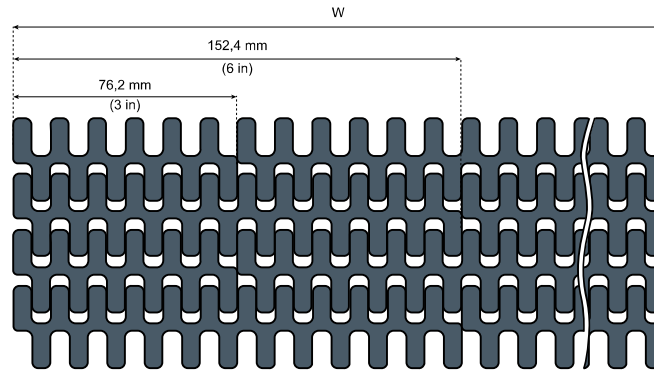

- Backflex radius:** 20 mm (0.79 in)
- Max load capacity:** 27000 N/m (1800 lbs/ft.)
- Weight:** 7.7 Kg/m² (1.57 lbs/ft².)
- Pin material:** PBT (water blue)
- Open surface:** 19%
- Standard length:**
 - width ≤ 15 in: 3,048 m (10 ft.)
 - width > 15in ≤ 66 in: 1,524 m (5 ft.)
 - width > 66 in: on request

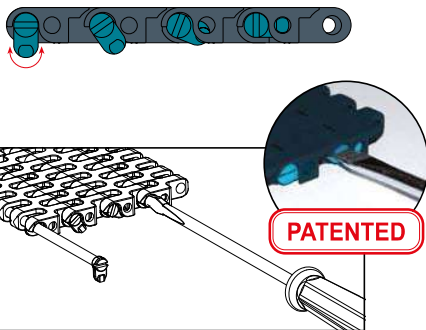

Standard material

NGE (GREY BLUE)

New Generation®

materials details:

7 3 5 6 3 a

Other version for 19,05 mm (3/4") belts:

2190 FT



Notes:
Schematic presentation of all flat top 19,05 mm (3/4") pitch belts

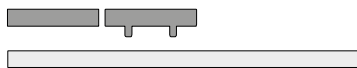

Information about this product is only available on our Smart Guide® website.



3 0 2 3 5 a

WIDTH W		ITEM DESCRIPTION
mm	in	
76	3.00	Go to: 3 0 2 2 0 a
152	6.00	
229	9.00	NGE2190FG-K900
305	12.00	NGE2190FG-K1200
381	15.00	NGE2190FG-K1500
457	18.00	NGE2190FG-K1800
533	21.00	NGE2190FG-K2100
610	24.00	NGE2190FG-K2400
686	27.00	NGE2190FG-K2700
762	30.00	NGE2190FG-K3000
838	33.00	NGE2190FG-K3300
914	36.00	NGE2190FG-K3600
991	39.00	NGE2190FG-K3900
1067	42.00	NGE2190FG-K4200
1143	45.00	NGE2190FG-K4500
1219	48.00	NGE2190FG-K4800
1295	51.00	NGE2190FG-K5100
1372	54.00	NGE2190FG-K5400
1448	57.00	NGE2190FG-K5700
1524	60.00	NGE2190FG-K6000
1600	63.00	NGE2190FG-K6300
1676	66.00	NGE2190FG-K6600
1753	69.00	NGE2190FG-K6900
1829	72.00	NGE2190FG-K7200
1905	75.00	NGE2190FG-K7500
1981	78.00	NGE2190FG-K7800
2057	81.00	NGE2190FG-K8100
2134	84.00	NGE2190FG-K8400
2210	87.00	NGE2190FG-K8700
2286	90.00	NGE2190FG-K9000

Other widths available on request.

Chains & sprockets	Wear strips	Side guide brackets & accessories	Levelers	Engineering manual
Modular belts & sprockets	Chain & belt return systems	Frame & structure supports	Bearing supports	
Curves & tracks	Side guide solutions	Miscellaneous products	Equipment	

3 0 2 3 5 a

DRIVE AND RETURN SPROCKETS

www.SystemPlastSmartGuide.com

FOR BELT 2190

Note:

Sprockets with 'fixed' bores (standard split types) do not follow the expansion or contraction of a belt and therefore can be used only for belts widths up to 680 mm (27-in) and temperature differences of maximum 30°C (86°F).

For all other applications we recommend using floating sprockets. Sprockets that normally have a 'fixed' or 'tight' bore can be made 'floating' on request. In that case just add the letter P to the standard item description.

For example, code **2190-17R25M-DPMS**

Sprockets with 'tight' bores (standard one piece types) can be a cost effective solution for many applications, but if the belt is wider than 680 mm (27-in) and large temperature fluctuations (> 30°C - 86°F) occur, we recommend using the floating versions. 'Tight' and 'floating' bore sprockets are recommended to be kept in position with set collars or with help of the positioners of the belt.

New design

3 0 9 9 0 a

Features:

- Very high strength.
- Split versions: quick and easy replacement.
- Foolproof design.
- Completely closed structure, easy to clean and to disinfect.
- Excellent wear and chemical resistance.
- Recyclable.

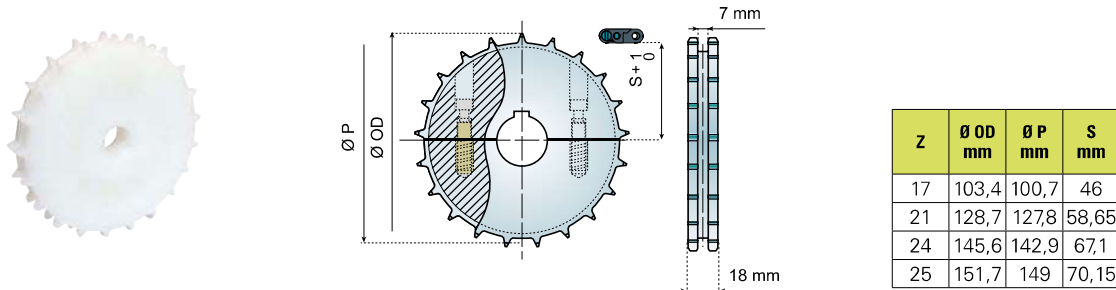

MACHINED DRIVE SPROCKETS - SPLIT FIXED					
Z	Ø 23*	Ø 25	Ø 30	Ø 35	Ø 40
ITEM DESCRIPTION					
17	-	2190-17R25M-DMS	2190-17R30M-DMS	2190-17R35M-DMS	-
21	-	2190-21R25M-DMS	2190-21R30M-DMS	2190-21R35M-DMS	2190-21R40M-DMS
24	-	2190-24R25M-DMS	2190-24R30M-DMS	2190-24R35M-DMS	2190-24R40M-DMS
25	-	2190-25R25M-DMS	2190-25R30M-DMS	2190-25R35M-DMS	2190-25R40M-DMS
MACHINED RETURN SPROCKETS - SPLIT					
17	2190-17R23M-RMS	2190-17R25M-RMS	2190-17R30M-RMS	2190-17R35M-RMS	-
21	2190-21R23M-RMS	2190-21R25M-RMS	2190-21R30M-RMS	2190-21R35M-RMS	2190-21R40M-RMS
24	2190-24R23M-RMS	2190-24R25M-RMS	2190-24R30M-RMS	2190-24R35M-RMS	2190-24R40M-RMS
25	2190-25R23M-RMS	2190-25R25M-RMS	2190-25R30M-RMS	2190-25R35M-RMS	2190-25R40M-RMS
MACHINED DRIVE SPROCKETS SQUARE BORE - SPLIT FLOATING					
Z	-	-	∇ 30X30	-	∇ 40X40
17	-	-	2190-17S30M-DMS	-	-
21	-	-	2190-21S30M-DMS	-	2190-21S40M-DMS
24	-	-	2190-24S30M-DMS	-	2190-24S40M-DMS
25	-	-	2190-25S30M-DMS	-	2190-25S40M-DMS

Material: polyamide (natural white), screws in stainless steel, bushings in brass. *Plain bore

See belts 2190:
3 0 1 9 0 a

Information about this product is only available on our Smart Guide® website.

Set collars, go to:
5 4 6 3 0 a

Chains & sprockets	Wear strips	Side guide brackets & accessories	Levelers	Engineering manual
Modular belts & sprockets	Chain & belt return systems	Frame & structure supports	Bearing supports	
Curves & tracks	Side guide solutions	Miscellaneous products	Equipment	

3 0 3 0 0 a

INDEX MODULAR BELTS

www.SystemPlastSmartGuide.com

25,4 mm (1") PITCH - THICKNESS: 8,7 mm (0,34 in)

FLAT TOP VERSION - 2250 FT



3 0 3 2 5 a



3 0 3 1 0 a

FLAT TOP - 2253 FT



3 0 3 3 0 a

FLAT TOP - VACUUM - 2253 FT



3 0 3 9 8 n

ROLLER TOP - 2253RTC



3 0 3 9 8 a

FLAT TOP VERSION WITH TRANSFER WING - 2250 FT



3 0 3 2 0 a

FLUSH GRID VERSION - 2250 FG

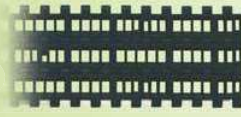

3 0 3 6 0 a



3 0 3 4 0 a

FLUSH GRID VERSION WITH TRANSFER WING - 2250 FG



3 0 3 5 0 a

VERSION WITH RUBBER INSERTS - 2250 VG

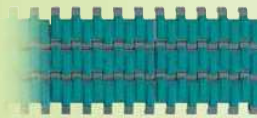

3 0 3 7 0 a

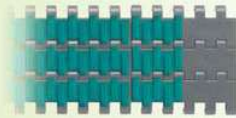

3 0 3 8 0 a

ALSO AVAILABLE: SIDE-FLEXING CHAINBELT

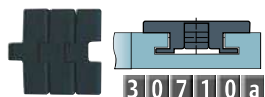

3 0 7 1 0 a

2250 TAB FT



3 0 7 0 0 a

2260 M FT

New



3 0 7 0 0 a

2260 M FG

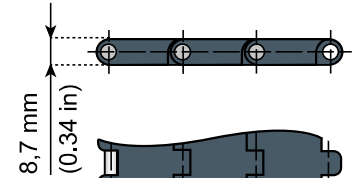

New

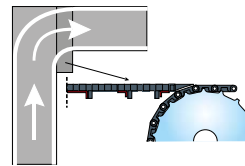

25,4 mm
(1 in)



Information about this product is only available on our Smart Guide® website.

Belts with flights

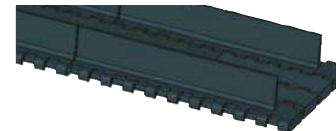

page code: 3 0 3 6 5 a



Chains & sprockets	Wear strips	Side guide brackets & accessories	Levelers	Engineering manual
Modular belts & sprockets	Chain & belt return systems	Frame & structure supports	Bearing supports	
Curves & tracks	Side guide solutions	Miscellaneous products	Equipment	

30310a

25,4 mm (1") 2250 MODULAR BELTS - THICKNESS: 8,7 mm (0.34 in)

www.SystemPlastSmartGuide.com

FLAT TOP VERSION



NG® evo conveyor components made from engineered plastic resin
 Longer wear life than acetal
 Lower friction than acetal
 Good chemical resistance
 High abrasion resistance
 It meets the requirement for materials as stated by EC1935/2004 and FDA CFR21 norms for direct food contact
 Less dust than with acetal chains
 More.....

SINGLE TRACK

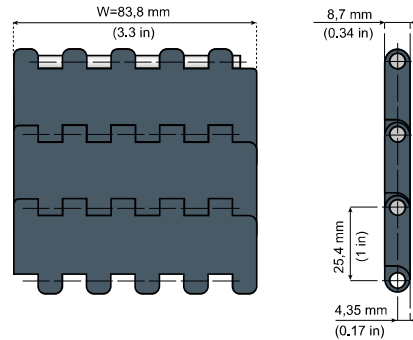

Pin material: PBT (white)

ITEM DESCRIPTION	MATERIAL	WIDTH W		PITCH P		BACKFLEX RADIUS		MAX LOAD CAPACITY		WEIGHT	
		mm	in	mm	in	mm	in	N	lbs	Kg/m	lbs/ft.
NGE2250FT-K330	NGE Grey Blue	83,8	3,3	25,4	1	25	0,98	1890	425	0,6	0,4
LFG2250FT-K330	LFG Grey	83,8	3,3	25,4	1	25	0,98	2100	470	0,6	0,4

Standard length: 120 pitches (3,048 m - 10 ft.)



SINGLE TRACK WITH POSITIONER

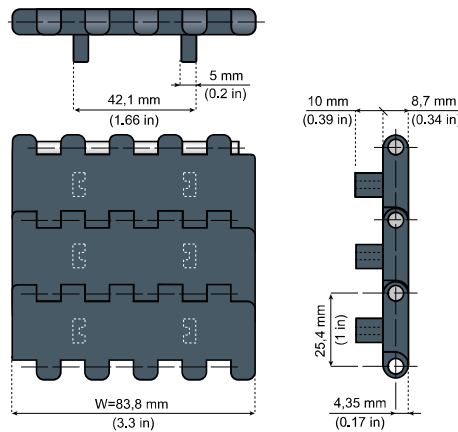

Pin material: PBT (white)

ITEM DESCRIPTION	MATERIAL	WIDTH W		PITCH P		BACKFLEX RADIUS		MAX LOAD CAPACITY		WEIGHT	
		mm	in	mm	in	mm	in	N	lbs	Kg/m	lbs/ft.
NGE2250FT-PT-K330	NGE Grey Blue	83,8	3,3	25,4	1	25	0,98	1890	425	0,6	0,4
LFG2250FT-PT-K330	LFG Grey	83,8	3,3	25,4	1	25	0,98	2100	470	0,6	0,4

Standard length: 120 pitches (3,048 m - 10 ft.)



Notes: Schematic presentation of all flat top 25,4 mm (1") pitch belts. Thickness: 8,7 mm (0.34 in)



Other versions for 25,4 mm (1") belts:

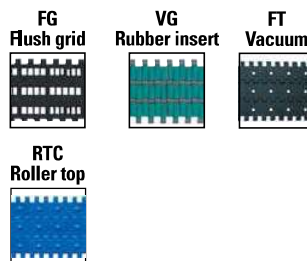

Standard materials

NGE (GREY BLUE)

New Generation®

LFG (GREY)

Low friction acetal resin

materials details:

73563a



Information about this product is only available on our Smart Guide® website.



Chains & sprockets	Wear strips	Side guide brackets & accessories	Levelers	Engineering manual
Modular belts & sprockets	Chain & belt return systems	Frame & structure supports	Bearing supports	
Curves & tracks	Side guide solutions	Miscellaneous products	Equipment	

SYSTEM PLAST®



30320a

25,4 mm (1") 2250 WITH TRANSFER WING - THICKNESS: 8,7 mm (0.34 in)

www.SystemPlastSmartGuide.com

SINGLE TRACK

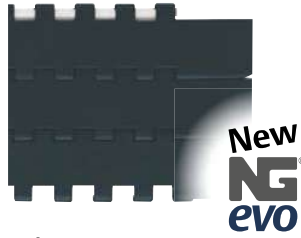

New NG evo

NG® evo conveyor components made from engineered plastic resin

Longer wearlife than acetal
Lower friction than acetal
Good chemical resistance
High abrasion resistance
It meets the requirement for materials as stated by EC1935/2004 and FDA CFR21 norms for direct food contact
Less dust than with acetal chains
More.....

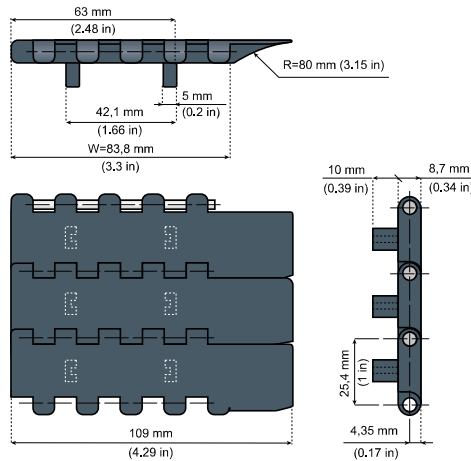

Standard material

NGE (GREY BLUE)

New Generation®

materials details:

73563a

Pin material: PBT (white)

ITEM DESCRIPTION	MATERIAL	WIDTH W		PITCH P		BACKFLEX RADIUS		MAX LOAD CAPACITY		WEIGHT	
		mm	in	mm	in	mm	in	N	lbs	Kg/m	lbs/ft.
NGE2250FT-PT-K330T	NGE Grey Blue	83,8	3.3	25,4	1	30	1.18	1890	425	0,7	0.47

Standard length: 120 pitches (3,048 m - 10 ft.)

WIDER VERSIONS

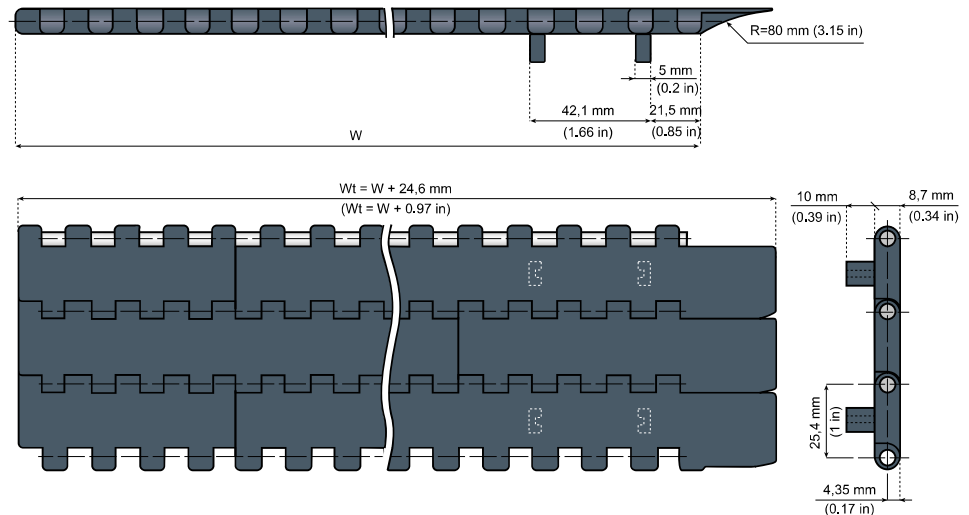
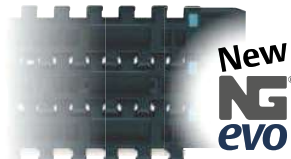

Backflex radius: 30 mm (1.18 in)

Max load capacity: 22500 N/m (1530 lbs/ft)

Weight: 7,4 Kg/m² (1.51 lbs/ft²)

Pin material: PBT (white)

Standard length:

width ≤ 340 mm: 3,048 m

width > 340 mm ≤ 1700 mm: 1,524 m

width > 1700 mm: on request



30395a



Information about this product is only available on our Smart Guide® website.

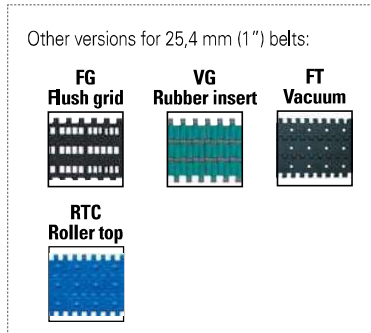
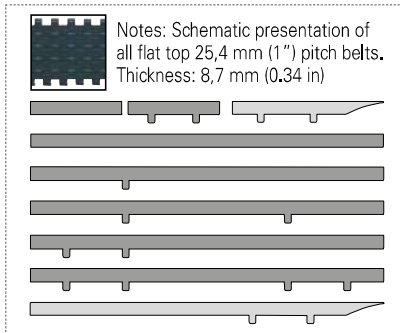

WIDTH W		ITEM DESCRIPTION
mm	in	
85	3.35	NGE2250FT-PT-M0085T
170	6.69	NGE2250FT-PT-M0170T
255	10.04	NGE2250FT-PT-M0255T
340	13.39	NGE2250FT-PT-M0340T
425	16.73	NGE2250FT-PT-M0425T
510	20.08	NGE2250FT-PT-M0510T

Other widths available on request.

Chains & sprockets	Wear strips	Side guide brackets & accessories	Levelers	Engineering manual
Modular belts & sprockets	Chain & belt return systems	Frame & structure supports	Bearing supports	
Curves & tracks	Side guide solutions	Miscellaneous products	Equipment	

3 0 3 2 5 a

25,4 mm (1") 2250 MODULAR BELTS - THICKNESS: 8,7 mm (0.34 in)

www.SystemPlastSmartGuide.com

FLAT TOP VERSION

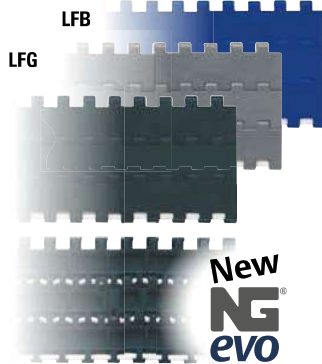

New
NG[®]
evo

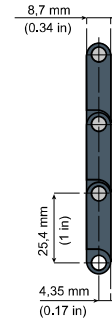
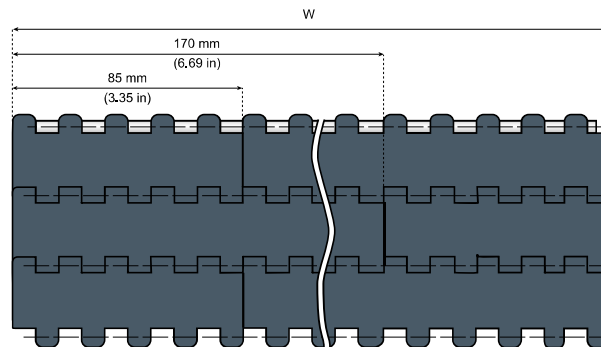

NG[®] evo conveyor components
made from engineered plastic resin

- Longer wearlife than acetal
- Lower friction than acetal
- Good chemical resistance
- High abrasion resistance
- It meets the requirement for materials as stated by EC1935/2004 and FDA CFR21 norms for direct food contact
- Less dust than with acetal chains
- More.....

Backflex radius: 25 mm (0,98 in)

Max load capacity (LFG & LFB): 25000 N/m (1700 lbs/ft.)

Weight: 7,4 Kg/m² (1,51 lbs/ft.²)

Pin material: PBT (white)

Standard length:

width ≤ 340 mm (13,39 in): 3,048 m (10 ft.)

width > 340 mm (13,39 in) ≤ 1700 mm (66,93 in): 1,524 m (5 ft.)

width > 1700 mm (66,93 in): on request

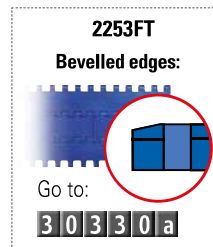

Belts with flights

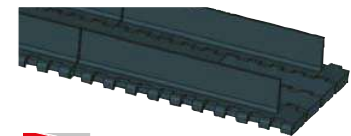

page code: **3 0 3 6 5 a**

Standard materials

NGE (GREY BLUE)	LFG (GREY)	LFB (BLUE)
New Generation®	Low friction acetal resin	

materials details:

7 3 5 6 3 a



Information about this product is only available on our Smart Guide® website.



3 0 3 9 5 a

Other versions for 25,4 mm (1") belts:

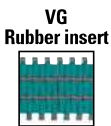
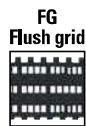

Notes: Schematic presentation of all flat top 25,4 mm (1") pitch belts. Thickness: 8,7 mm (0,34 in)



WIDTH W		ITEM DESCRIPTION		
mm	in	NGE (GREY BLUE)	LFG (GREY)	LFB (BLUE)
85	3.35	NGE2250FT-M0085	LFG2250FT-M0085	LFB2250FT-M0085
170	6.69	NGE2250FT-M0170	LFG2250FT-M0170	LFB2250FT-M0170
255	10.04	NGE2250FT-M0255	LFG2250FT-M0255	LFB2250FT-M0255
340	13.39	NGE2250FT-M0340	LFG2250FT-M0340	LFB2250FT-M0340
425	16.73	NGE2250FT-M0425	LFG2250FT-M0425	LFB2250FT-M0425
510	20.08	NGE2250FT-M0510	LFG2250FT-M0510	LFB2250FT-M0510
595	23.43	NGE2250FT-M0595	LFG2250FT-M0595	LFB2250FT-M0595
680	26.77	NGE2250FT-M0680	LFG2250FT-M0680	LFB2250FT-M0680
765	30.12	NGE2250FT-M0765	LFG2250FT-M0765	LFB2250FT-M0765
850	33.46	NGE2250FT-M0850	LFG2250FT-M0850	LFB2250FT-M0850
935	36.81	NGE2250FT-M0935	LFG2250FT-M0935	LFB2250FT-M0935
1020	40.16	NGE2250FT-M1020	LFG2250FT-M1020	LFB2250FT-M1020
1105	43.50	NGE2250FT-M1105	LFG2250FT-M1105	LFB2250FT-M1105
1190	46.85	NGE2250FT-M1190	LFG2250FT-M1190	LFB2250FT-M1190
1275	50.20	NGE2250FT-M1275	LFG2250FT-M1275	LFB2250FT-M1275
1360	53.54	NGE2250FT-M1360	LFG2250FT-M1360	LFB2250FT-M1360
1445	56.89	NGE2250FT-M1445	LFG2250FT-M1445	LFB2250FT-M1445
1530	60.24	NGE2250FT-M1530	LFG2250FT-M1530	LFB2250FT-M1530
1615	63.58	NGE2250FT-M1615	LFG2250FT-M1615	LFB2250FT-M1615
1700	66.93	NGE2250FT-M1700	LFG2250FT-M1700	LFB2250FT-M1700
1785	70.28	NGE2250FT-M1785	LFG2250FT-M1785	LFB2250FT-M1785
1870	73.62	NGE2250FT-M1870	LFG2250FT-M1870	LFB2250FT-M1870
1955	76.97	NGE2250FT-M1955	LFG2250FT-M1955	LFB2250FT-M1955
2040	80.31	NGE2250FT-M2040	LFG2250FT-M2040	LFB2250FT-M2040
2125	83.66	NGE2250FT-M2125	LFG2250FT-M2125	LFB2250FT-M2125
2210	87.01	NGE2250FT-M2210	LFG2250FT-M2210	LFB2250FT-M2210
2295	90.35	NGE2250FT-M2295	LFG2250FT-M2295	LFB2250FT-M2295

Other widths available on request.

Chains & sprockets	Wear strips	Side guide brackets & accessories	Levelers	Engineering manual
Modular belts & sprockets	Chain & belt return systems	Frame & structure supports	Bearing supports	
Curves & tracks	Side guide solutions	Miscellaneous products	Equipment	

30330a

25,4 mm (1") 2253 MODULAR BELTS - THICKNESS: 8,7 mm (0.34 in)

www.SystemPlastSmartGuide.com

FLAT TOP VERSION - 76,2 mm (3 in) MODULES

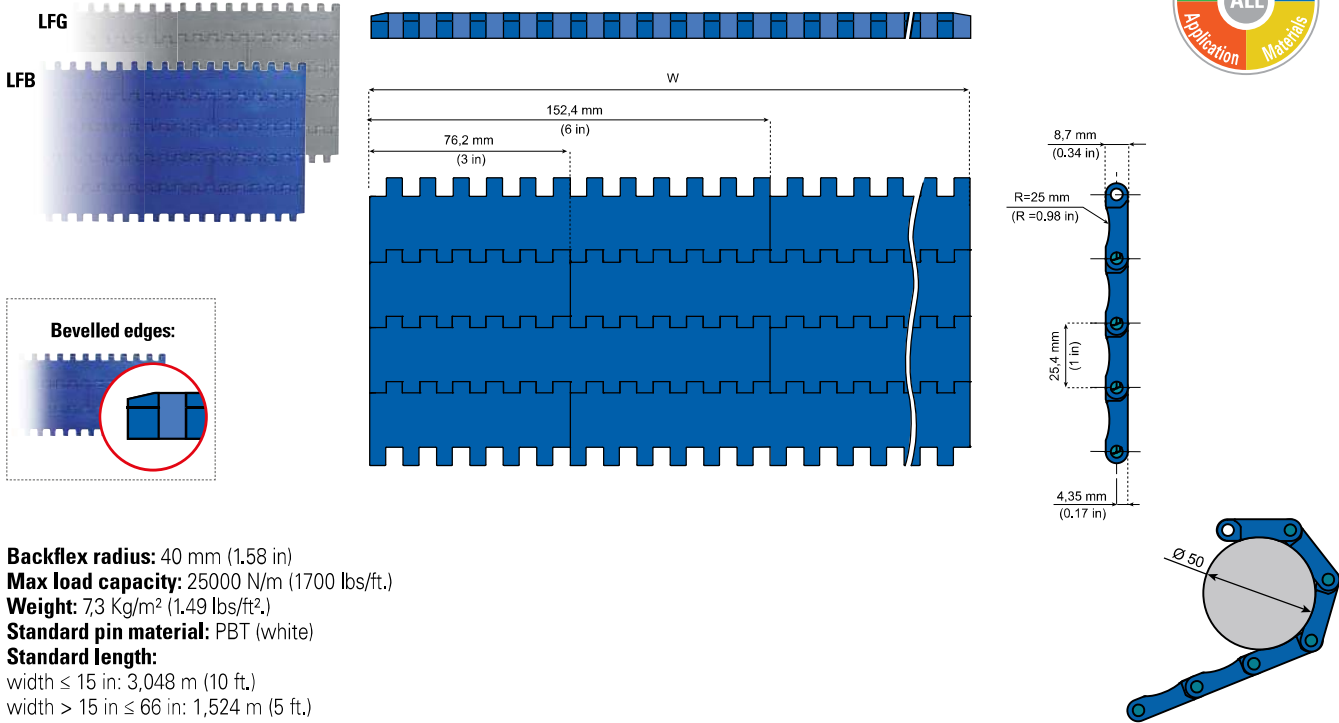

Backflex radius: 40 mm (1,58 in)
Max load capacity: 25000 N/m (1700 lbs/ft.)
Weight: 7,3 Kg/m² (1,49 lbs/ft.²)
Standard pin material: PBT (white)
Standard length:
width ≤ 15 in: 3,048 m (10 ft.)
width > 15 in ≤ 66 in: 1,524 m (5 ft.)
width > 66 in: on request

30395a



Information about this product is only available on our Smart Guide® website.

Standard materials

LFB (BLUE)

Low friction acetal resin

LFG (GREY)

Low friction acetal resin

materials details:

73563a

Other versions for 25,4 mm (1") belts:



Also available in metric version. Go to:

30325a

Other versions for 25,4 mm (1") belts:

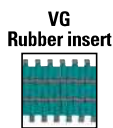
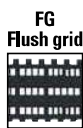

Notes: Schematic presentation of all flat top 25,4 mm (1") pitch belts. Thickness: 8,7 mm (0,34 in)



WIDTH W		ITEM DESCRIPTION	
mm	in	LFB (BLUE)	LFG (GREY)
76	3,00	LFB2253FT-K300	LFG2253FT-K300
152	6,00	LFB2253FT-K600	LFG2253FT-K600
229	9,00	LFB2253FT-K900	LFG2253FT-K900
305	12,00	LFB2253FT-K1200	LFG2253FT-K1200
381	15,00	LFB2253FT-K1500	LFG2253FT-K1500
457	18,00	LFB2253FT-K1800	LFG2253FT-K1800
533	21,00	LFB2253FT-K2100	LFG2253FT-K2100
610	24,00	LFB2253FT-K2400	LFG2253FT-K2400
686	27,00	LFB2253FT-K2700	LFG2253FT-K2700
762	30,00	LFB2253FT-K3000	LFG2253FT-K3000
838	33,00	LFB2253FT-K3300	LFG2253FT-K3300
914	36,00	LFB2253FT-K3600	LFG2253FT-K3600
991	39,00	LFB2253FT-K3900	LFG2253FT-K3900
1067	42,00	LFB2253FT-K4200	LFG2253FT-K4200
1143	45,00	LFB2253FT-K4500	LFG2253FT-K4500
1219	48,00	LFB2253FT-K4800	LFG2253FT-K4800
1295	51,00	LFB2253FT-K5100	LFG2253FT-K5100
1372	54,00	LFB2253FT-K5400	LFG2253FT-K5400
1448	57,00	LFB2253FT-K5700	LFG2253FT-K5700
1524	60,00	LFB2253FT-K6000	LFG2253FT-K6000
1600	63,00	LFB2253FT-K6300	LFG2253FT-K6300
1676	66,00	LFB2253FT-K6600	LFG2253FT-K6600
1753	69,00	LFB2253FT-K6900	LFG2253FT-K6900
1829	72,00	LFB2253FT-K7200	LFG2253FT-K7200
1905	75,00	LFB2253FT-K7500	LFG2253FT-K7500
1981	78,00	LFB2253FT-K7800	LFG2253FT-K7800
2057	81,00	LFB2253FT-K8100	LFG2253FT-K8100
2134	84,00	LFB2253FT-K8400	LFG2253FT-K8400
2210	87,00	LFB2253FT-K8700	LFG2253FT-K8700
2286	90,00	LFB2253FT-K9000	LFG2253FT-K9000
2362	93,00	LFB2253FT-K9300	LFG2253FT-K9300
2438	96,00	LFB2253FT-K9600	LFG2253FT-K9600

Other widths available on request.

Chains & sprockets	Wear strips	Side guide brackets & accessories	Levelers	Engineering manual
Modular belts & sprockets	Chain & belt return systems	Frame & structure supports	Bearing supports	
Curves & tracks	Side guide solutions	Miscellaneous products	Equipment	

3 0 3 3 5 a

25,4 mm (1") 2250 MODULAR BELTS - THICKNESS: 8,7 mm (0.34 in)

www.SystemPlastSmartGuide.com

FLAT TOP VERSION WITH POSITIONERS

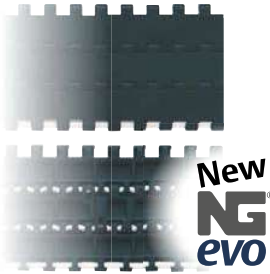

NG® evo conveyor components made from engineered plastic resin

- Longer wearlife than acetal
- Lower friction than acetal
- Good chemical resistance
- High abrasion resistance
- It meets the requirement for materials as stated by EC1935/2004 and FDA CFR21 norms for direct food contact
- Less dust than with acetal chains
- More.....

- Backflex radius:** 25 mm (0.98 in)
- Max load capacity:** 22500 N/m (1530 lbs/ft.)
- Weight:** 7.4 Kg/m² (1.51 lbs/ft.²)
- Pin material:** PBT (white)
- Standard length:**
 - width ≤ 340 mm (13.39 in): 3,048 m (10 ft.)
 - width > 340 mm (13.39 in) ≤ 1700 mm (66.93 in): 1,524 m (5 ft.)
 - width > 1700 mm (66.93 in): on request

2250FT-P

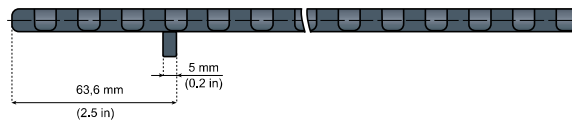

2250FT-P2

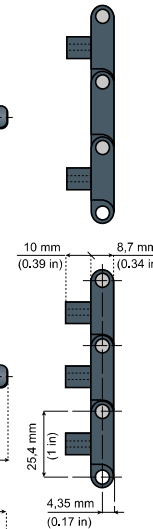
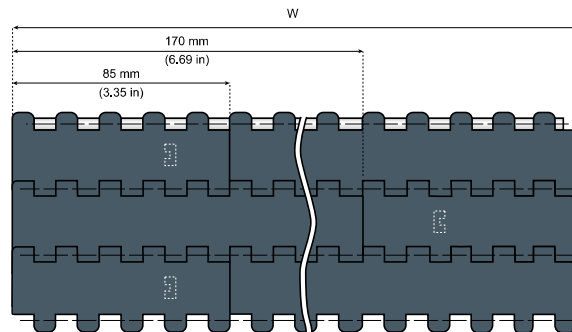
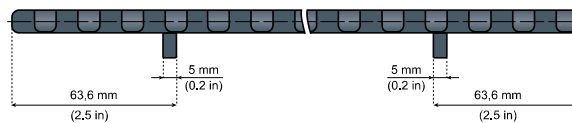

3 0 3 9 5 a

Other versions for 25,4 mm (1") belts:

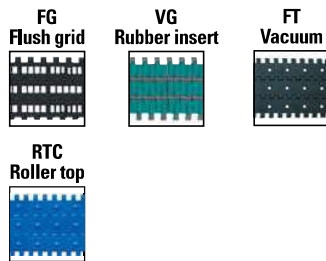

Notes: Schematic presentation of all flat top 25,4 mm (1") pitch belts. Thickness: 8,7 mm (0.34 in)

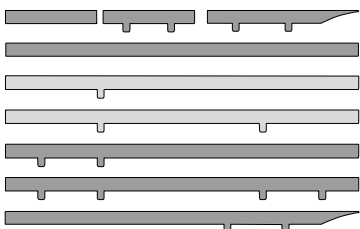

Information about this product is only available on our Smart Guide® website.

Standard material

NGE (GREY BLUE)

New Generation®

materials details:

7 3 5 6 3 a

WIDTH W		ITEM DESCRIPTION	ITEM DESCRIPTION
mm	in		
85	3.35	NGE2250FT-P-M0085	Go to: 3 0 3 3 5 b
170	6.69	NGE2250FT-P-M0170	NGE2250FT-P2-M0170
255	10.04	NGE2250FT-P-M0255	NGE2250FT-P2-M0255
340	13.39	NGE2250FT-P-M0340	NGE2250FT-P2-M0340
425	16.73	NGE2250FT-P-M0425	NGE2250FT-P2-M0425
510	20.08	NGE2250FT-P-M0510	NGE2250FT-P2-M0510
595	23.43	NGE2250FT-P-M0595	NGE2250FT-P2-M0595
680	26.77	NGE2250FT-P-M0680	NGE2250FT-P2-M0680
765	30.12	NGE2250FT-P-M0765	NGE2250FT-P2-M0765
850	33.46	NGE2250FT-P-M0850	NGE2250FT-P2-M0850
935	36.81	NGE2250FT-P-M0935	NGE2250FT-P2-M0935
1020	40.16	NGE2250FT-P-M1020	NGE2250FT-P2-M1020
1105	43.50	NGE2250FT-P-M1105	NGE2250FT-P2-M1105
1190	46.85	NGE2250FT-P-M1190	NGE2250FT-P2-M1190
1275	50.20	NGE2250FT-P-M1275	NGE2250FT-P2-M1275
1360	53.54	NGE2250FT-P-M1360	NGE2250FT-P2-M1360
1445	56.89	NGE2250FT-P-M1445	NGE2250FT-P2-M1445
1530	60.24	NGE2250FT-P-M1530	NGE2250FT-P2-M1530
1615	63.58	NGE2250FT-P-M1615	NGE2250FT-P2-M1615
1700	66.93	NGE2250FT-P-M1700	NGE2250FT-P2-M1700
1785	70.28	NGE2250FT-P-M1785	NGE2250FT-P2-M1785
1870	73.62	NGE2250FT-P-M1870	NGE2250FT-P2-M1870

Other widths available on request.



Chains & sprockets	Wear strips	Side guide brackets & accessories	Levelers	Engineering manual
Modular belts & sprockets	Chain & belt return systems	Frame & structure supports	Bearing supports	
Curves & tracks	Side guide solutions	Miscellaneous products	Equipment	



3 0 3 3 5 b

25,4 mm (1") 2250 MODULAR BELTS - THICKNESS: 8,7 mm (0.34 in)

www.SystemPlastSmartGuide.com

FLAT TOP VERSION WITH TWIN POSITIONERS

LFG

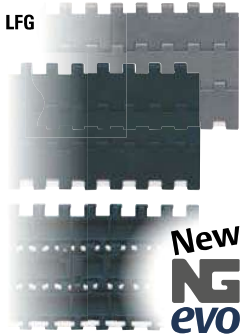

New
NG[®] evo

NG[®] evo conveyor components made from engineered plastic resin

- Longer wearlife than acetal
- Lower friction than acetal
- Good chemical resistance
- High abrasion resistance
- It meets the requirement for materials as stated by EC1935/2004 and FDA CFR21 norms for direct food contact
- Less dust than with acetal chains
- More.....

Backflex radius: 25 mm (0.98 in)

Max load capacity (LFG):

25000 N/m (1700 lbs/ft.)

Weight: 7,4 Kg/m² (1,51 lbs/ft².)

Pin material: PBT (white)

Standard length:

width ≤ 340 mm (13.39 in): 3,048 m (10 ft.)

width > 340 mm (13.39 in) ≤ 1700 mm (66.93 in): 1,524 m (5 ft.)

width > 1700 mm (66.93 in): on request

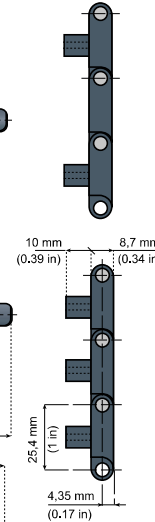
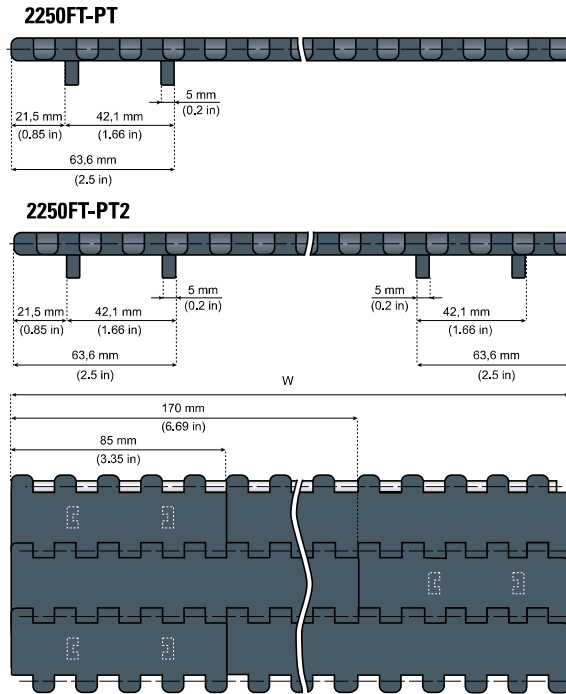

Other versions for 25,4 mm (1") belts:

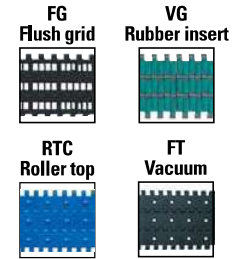

Notes: Schematic presentation of all flat top 25,4 mm (1") pitch belts. Thickness: 8,7 mm (0,34 in)

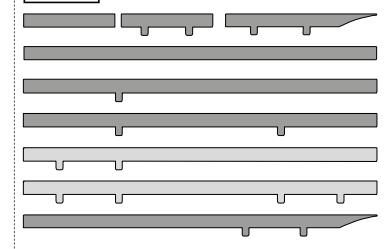

3 0 3 3 9 5 a



Information about this product is only available on our Smart Guide® website.

Standard materials

NGE (GREY BLUE)

New Generation®

LFG (GREY)

Low friction acetal resin

materials details:

7 3 5 6 3 a

WIDTH W		ITEM DESCRIPTION	
mm	in	NGE (GREY BLUE)	LFG (GREY)
85	3.35	NGE2250FT-PT-M0085	LFG2250FT-PT-M0085
170	6.69	NGE2250FT-PT-M0170	LFG2250FT-PT-M0170
255	10.04	NGE2250FT-PT-M0255	LFG2250FT-PT-M0255
340	13.39	NGE2250FT-PT-M0340	LFG2250FT-PT-M0340
425	16.73	NGE2250FT-PT-M0425	LFG2250FT-PT-M0425
510	20.08	NGE2250FT-PT-M0510	LFG2250FT-PT-M0510
595	23.43	NGE2250FT-PT-M0595	LFG2250FT-PT-M0595
680	26.77	NGE2250FT-PT-M0680	LFG2250FT-PT-M0680
765	30.12	NGE2250FT-PT-M0765	LFG2250FT-PT-M0765
850	33.46	NGE2250FT-PT-M0850	LFG2250FT-PT-M0850
935	36.81	NGE2250FT-PT-M0935	LFG2250FT-PT-M0935
1020	40.16	NGE2250FT-PT-M1020	LFG2250FT-PT-M1020
1105	43.50	NGE2250FT-PT-M1105	LFG2250FT-PT-M1105
1190	46.85	NGE2250FT-PT-M1190	LFG2250FT-PT-M1190
1275	50.20	NGE2250FT-PT-M1275	LFG2250FT-PT-M1275
1360	53.54	NGE2250FT-PT-M1360	LFG2250FT-PT-M1360
1445	56.89	NGE2250FT-PT-M1445	LFG2250FT-PT-M1445
1530	60.24	NGE2250FT-PT-M1530	LFG2250FT-PT-M1530
1615	63.58	NGE2250FT-PT-M1615	LFG2250FT-PT-M1615
1700	66.93	NGE2250FT-PT-M1700	LFG2250FT-PT-M1700
1785	70.28	NGE2250FT-PT-M1785	LFG2250FT-PT-M1785
1870	73.62	NGE2250FT-PT-M1870	LFG2250FT-PT-M1870

ITEM DESCRIPTION	
NGE (GREY BLUE)	LFG (GREY)
-	-
NGE2250FT-PT2-M0170	LFG2250FT-PT2-M0170
NGE2250FT-PT2-M0255	LFG2250FT-PT2-M0255
NGE2250FT-PT2-M0340	LFG2250FT-PT2-M0340
NGE2250FT-PT2-M0425	LFG2250FT-PT2-M0425
NGE2250FT-PT2-M0510	LFG2250FT-PT2-M0510
NGE2250FT-PT2-M0595	LFG2250FT-PT2-M0595
NGE2250FT-PT2-M0680	LFG2250FT-PT2-M0680
NGE2250FT-PT2-M0765	LFG2250FT-PT2-M0765
NGE2250FT-PT2-M0850	LFG2250FT-PT2-M0850
NGE2250FT-PT2-M0935	LFG2250FT-PT2-M0935
NGE2250FT-PT2-M1020	LFG2250FT-PT2-M1020
NGE2250FT-PT2-M1105	LFG2250FT-PT2-M1105
NGE2250FT-PT2-M1190	LFG2250FT-PT2-M1190
NGE2250FT-PT2-M1275	LFG2250FT-PT2-M1275
NGE2250FT-PT2-M1360	LFG2250FT-PT2-M1360
NGE2250FT-PT2-M1445	LFG2250FT-PT2-M1445
NGE2250FT-PT2-M1530	LFG2250FT-PT2-M1530
NGE2250FT-PT2-M1615	LFG2250FT-PT2-M1615
NGE2250FT-PT2-M1700	LFG2250FT-PT2-M1700
NGE2250FT-PT2-M1785	LFG2250FT-PT2-M1785
NGE2250FT-PT2-M1870	LFG2250FT-PT2-M1870

Other widths available on request.



Chains & sprockets	Wear strips	Side guide brackets & accessories	Levelers	Engineering manual
Modular belts & sprockets	Chain & belt return systems	Frame & structure supports	Bearing supports	
Curves & tracks	Side guide solutions	Miscellaneous products	Equipment	

3 0 3 4 0 a

25,4 mm (1") 2250 MODULAR BELTS - THICKNESS: 8,7 mm (0,34 in)

www.SystemPlastSmartGuide.com

SINGLE TRACK FLUSH GRID

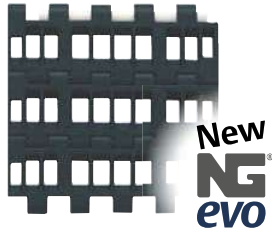

2250FG- K330

2250FG-PT-K330

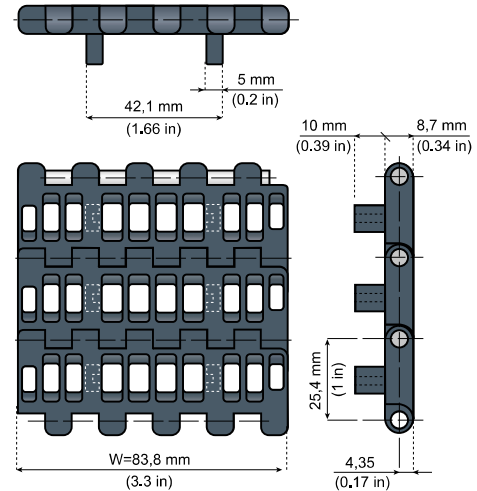
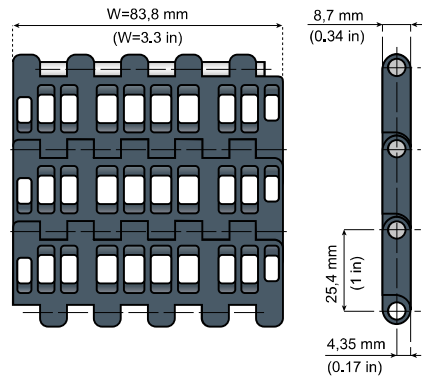

NG® evo conveyor components made from engineered plastic resin
 Longer wearlife than acetal
 Lower friction than acetal
 Good chemical resistance
 High abrasion resistance
 It meets the requirement for materials as stated by EC1935/2004 and FDA CFR21 norms for direct food contact
 Less dust than with acetal chains
 More.....

Pin material: PBT (white)
Open surface: 23%

ITEM DESCRIPTION	MATERIAL	WIDTH W		PITCH P		BACKFLEX RADIUS		MAX LOAD CAPACITY		WEIGHT	
		mm	in	mm	in	mm	in	N	lbs	Kg/m	lbs/ft.
NGE2250FG-K330	NGE Grey Blue	83,8	3,3	25,4	1	25	0,98	1890	425	0,5	0,34
NGE2250FG-PT-K330											

Standard length: 120 pitches (3,048 m - 10 ft.)

3 0 3 9 5 a

Other versions for 25,4 mm (1") belts:

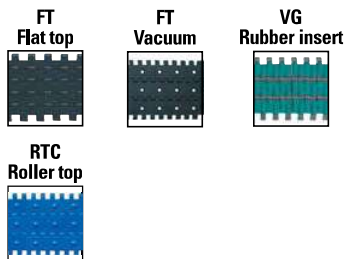

Notes: Schematic presentation of all flush grid 25,4 mm (1") pitch belts. Thickness: 8,7 mm (0,34 in)



Information about this product is only available on our Smart Guide® website.

Standard material

NGE (GREY BLUE)

New Generation®

materials details:

7 3 5 6 3 a

Chains & sprockets	Wear strips	Side guide brackets & accessories	Levelers	Engineering manual
Modular belts & sprockets	Chain & belt return systems	Frame & structure supports	Bearing supports	
Curves & tracks	Side guide solutions	Miscellaneous products	Equipment	

30350a

25,4 mm (1") 2250 MODULAR BELTS - THICKNESS: 8,7 mm (0.34 in)

www.SystemPlastSmartGuide.com

FLUSH GRID VERSION

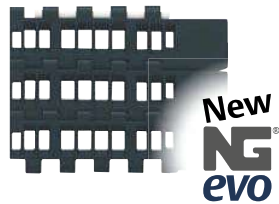

NG® evo conveyor components made from engineered plastic resin
 Longer wearlife than acetal
 Lower friction than acetal
 Good chemical resistance
 High abrasion resistance
 It meets the requirement for materials as stated by EC1935/2004 and FDA CFR21 norms for direct food contact
 Less dust than with acetal chains
 More.....

SINGLE TRACK

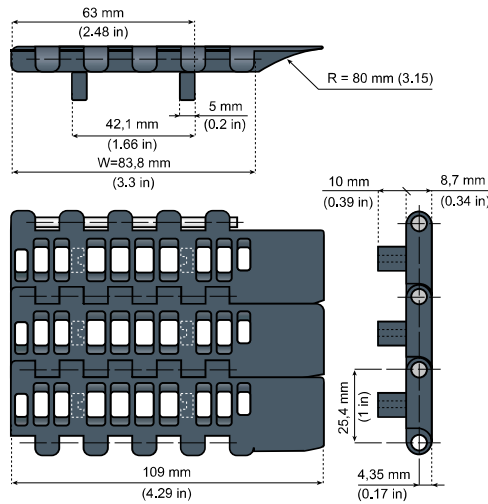

Information about this product is only available on our Smart Guide® website.

Standard material

NGE (GREY BLUE)

New Generation®

materials details:

73563a

Open surface: 23%

ITEM DESCRIPTION	MATERIAL	WIDTH W		PITCH P		BACKFLEX RADIUS		MAX LOAD CAPACITY		WEIGHT	
		mm	in	mm	in	mm	in	N	lbs	Kg/m	lbs/ft.
NGE2250FG-PT-K330T	NGE Grey Blue	83,8	3,3	25,4	1	30	1,18	1890	425	0,7	0,47

Standard length: 120 pitches (3,048 m - 10 ft)

WIDER VERSIONS

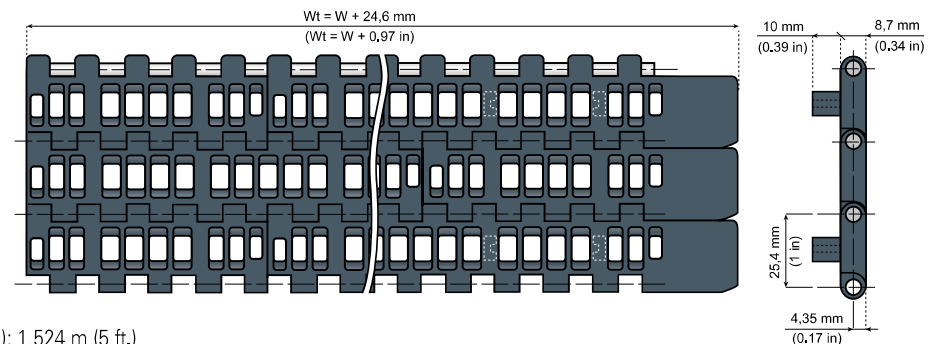
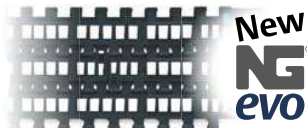
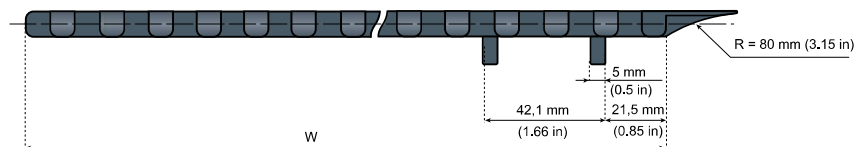

Backflex radius: 30 mm (1.18)
Max load capacity: 22500 N/m (1530 lbs/ft.)
Weight: 7,5 Kg/m² (1,53 lbs/ft.²)
Pin material: PBT (white)
Open surface: 23%
Standard length:

width ≤ 340 mm (13.39 in): 3,048 m (10 ft.)
 width > 340 mm (13.39 in) ≤ 1700 mm (66.93 in): 1,524 m (5 ft.)
 width > 1700 mm (66.93 in): on request

30395a



Notes: Schematic presentation of all flush grid 25,4 mm (1") pitch belts. Thickness: 8,7 mm (0.34 in)

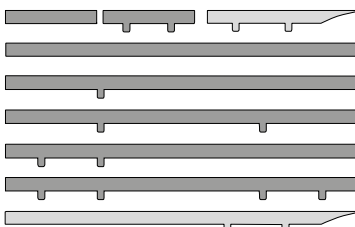

Other versions for 25,4 mm (1") belts:

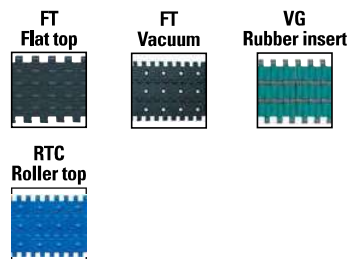

EXAMPLE INSTALLATION

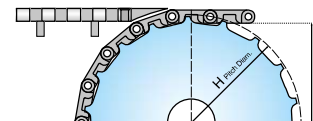

WIDTH W		ITEM DESCRIPTION
mm	in	
85	3,35	NGE2250FG-PT-M0085T
170	6,69	NGE2250FG-PT-M0170T
255	10,04	NGE2250FG-PT-M0255T
340	13,39	NGE2250FG-PT-M0340T
425	16,73	NGE2250FG-PT-M0425T
510	20,08	NGE2250FG-PT-M0510T

Other widths available on request.

Chains & sprockets	Wear strips	Side guide brackets & accessories	Levelers	Engineering manual
Modular belts & sprockets	Chain & belt return systems	Frame & structure supports	Bearing supports	
Curves & tracks	Side guide solutions	Miscellaneous products	Equipment	

30360a

25,4 mm (1") 2250 MODULAR BELTS - THICKNESS: 8,7 mm (0.34 in)

www.SystemPlastSmartGuide.com

FLUSH GRID VERSION

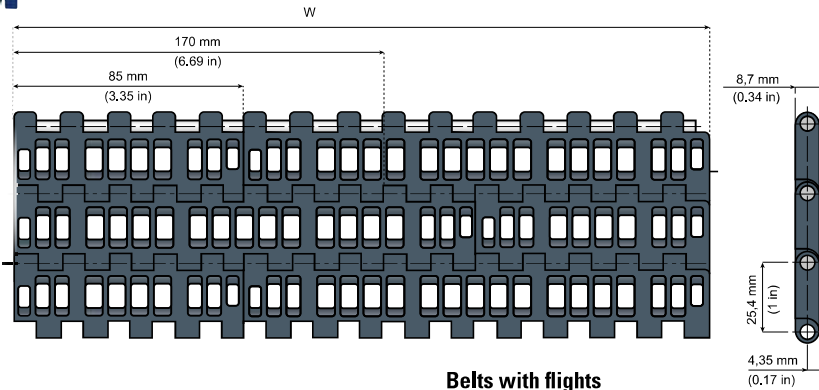
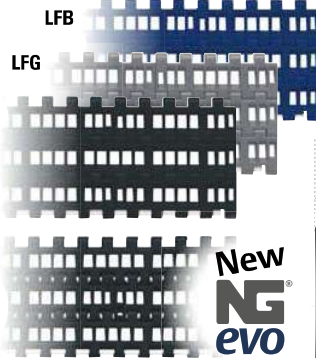

NG®evo conveyor components made from engineered plastic resin

- Longer wearlife than acetal
- Lower friction than acetal
- Good chemical resistance
- High abrasion resistance
- It meets the requirement for materials as stated by EC1935/2004 and FDA CFR21 norms for direct food contact
- Less dust than with acetal chains
- More.....

Backflex radius: 25 mm (0,98 in)

Max load capacity (LFG & LFB):

25000 N/m (1700 lbs/ft.)

Weight: 7,3 Kg/m² (1.48 lbs/ft².)

Pin material: PBT (white)

Open surface: 23%

Standard length:

width ≤ 340 mm (13.39 in): 3,048 m (10 ft.)

width > 340 mm (13.39 in) ≤ 1700 mm (66.93 in): 1,524 m (5 ft.)

width > 1700 mm (66.93 in): on request

Belts with flights



page code:

30365a

Standard materials

NGE (GREY BLUE)	LFG (GREY)	LFB (BLUE)
New Generation®	Low friction acetal resin	

materials details:

73563a

Information about this product is only available on our Smart Guide® website.

30395a

Other versions for 25,4 mm (1") belts:

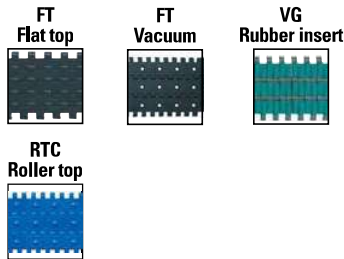

Notes: Schematic presentation of all flush grid 25,4 mm (1") pitch belts. Thickness: 8,7 mm (0,34 in)

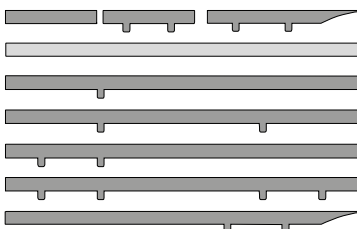

WIDTH W		ITEM DESCRIPTION		
mm	in	NGE (GREY BLUE)	LFG (GREY)	LFB (BLUE)
85	3.35	NGE2250FG-M0085	LFG2250FG-M0085	LFB2250FG-M0085
170	6.69	NGE2250FG-M0170	LFG2250FG-M0170	LFB2250FG-M0170
255	10.04	NGE2250FG-M0255	LFG2250FG-M0255	LFB2250FG-M0255
340	13.39	NGE2250FG-M0340	LFG2250FG-M0340	LFB2250FG-M0340
425	16.73	NGE2250FG-M0425	LFG2250FG-M0425	LFB2250FG-M0425
510	20.08	NGE2250FG-M0510	LFG2250FG-M0510	LFB2250FG-M0510
595	23.43	NGE2250FG-M0595	LFG2250FG-M0595	LFB2250FG-M0595
680	26.77	NGE2250FG-M0680	LFG2250FG-M0680	LFB2250FG-M0680
765	30.12	NGE2250FG-M0765	LFG2250FG-M0765	LFB2250FG-M0765
850	33.46	NGE2250FG-M0850	LFG2250FG-M0850	LFB2250FG-M0850
935	36.81	NGE2250FG-M0935	LFG2250FG-M0935	LFB2250FG-M0935
1020	40.16	NGE2250FG-M1020	LFG2250FG-M1020	LFB2250FG-M1020
1105	43.50	NGE2250FG-M1105	LFG2250FG-M1105	LFB2250FG-M1105
1190	46.85	NGE2250FG-M1190	LFG2250FG-M1190	LFB2250FG-M1190
1275	50.20	NGE2250FG-M1275	LFG2250FG-M1275	LFB2250FG-M1275
1360	53.54	NGE2250FG-M1360	LFG2250FG-M1360	LFB2250FG-M1360
1445	56.89	NGE2250FG-M1445	LFG2250FG-M1445	LFB2250FG-M1445
1530	60.24	NGE2250FG-M1530	LFG2250FG-M1530	LFB2250FG-M1530
1615	63.58	NGE2250FG-M1615	LFG2250FG-M1615	LFB2250FG-M1615
1700	66.93	NGE2250FG-M1700	LFG2250FG-M1700	LFB2250FG-M1700
1785	70.28	NGE2250FG-M1785	LFG2250FG-M1785	LFB2250FG-M1785
1870	73.62	NGE2250FG-M1870	LFG2250FG-M1870	LFB2250FG-M1870
1955	76.97	NGE2250FG-M1955	LFG2250FG-M1955	LFB2250FG-M1955
2040	80.31	NGE2250FG-M2040	LFG2250FG-M2040	LFB2250FG-M2040
2125	83.66	NGE2250FG-M2125	LFG2250FG-M2125	LFB2250FG-M2125
2210	87.01	NGE2250FG-M2210	LFG2250FG-M2210	LFB2250FG-M2210
2295	90.35	NGE2250FG-M2295	LFG2250FG-M2295	LFB2250FG-M2295

Other widths available on request.

Chains & sprockets	Wear strips	Side guide brackets & accessories	Levelers	Engineering manual
Modular belts & sprockets	Chain & belt return systems	Frame & structure supports	Bearing supports	
Curves & tracks	Side guide solutions	Miscellaneous products	Equipment	

30360b

25,4 mm (1") 2250 MODULAR BELTS - THICKNESS: 8,7 mm (0.34 in)

www.SystemPlastSmartGuide.com

FLUSH GRID VERSION WITH POSITIONERS



NG® evo conveyor components made from engineered plastic resin

- Longer wearlife than acetal
- Lower friction than acetal
- Good chemical resistance
- High abrasion resistance
- It meets the requirement for materials as stated by EC1935/2004 and FDA CFR21 norms for direct food contact
- Less dust than with acetal chains
- More.....

Backflex radius: 25 mm (0.98 in)

Max load capacity:

22500 N/m (1530 lbs/ft.)

Weight: 7,3 Kg/m² (1,48 lbs/ft².)

Pin material: PBT (white)

Open surface: 23%

Standard length:

width ≤ 340 mm (13.39 in): 3,048 m (10 ft.)

width > 340 mm (13.39 in) ≤ 1700 mm (66.93 in): 1,524 m (5 ft.)

width > 1700 mm (66.93 in): on request

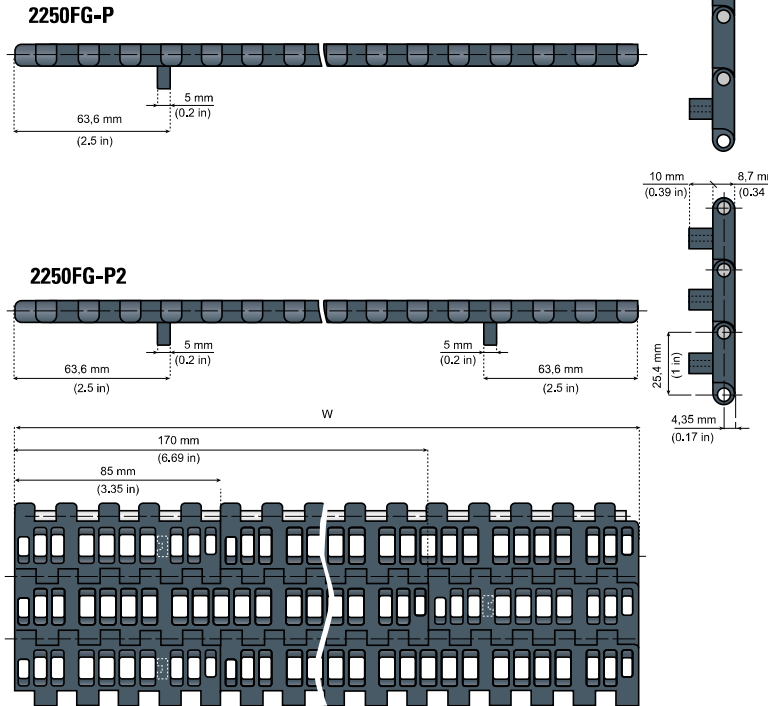

30395a

Other versions for 25,4 mm (1") belts:

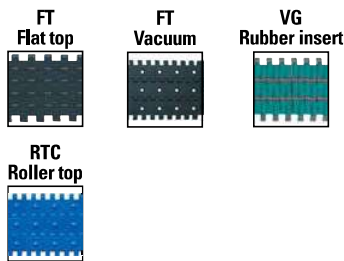

Notes: Schematic presentation of all flush grid 25,4 mm (1") pitch belts. Thickness: 8,7 mm (0,34 in)

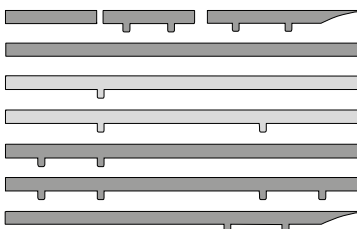

Information about this product is only available on our Smart Guide® website.

Standard material

NGE (GREY BLUE)

New Generation®

materials details:

73563a

WIDTH W		ITEM DESCRIPTION	ITEM DESCRIPTION
mm	in		
85	3,35	NGE2250FG-P-M0085	-
170	6.69	NGE2250FG-P-M0170	NGE2250FG-P2-M0170
255	10.04	NGE2250FG-P-M0255	NGE2250FG-P2-M0255
340	13.39	NGE2250FG-P-M0340	NGE2250FG-P2-M0340
425	16.73	NGE2250FG-P-M0425	NGE2250FG-P2-M0425
510	20.08	NGE2250FG-P-M0510	NGE2250FG-P2-M0510
595	23.43	NGE2250FG-P-M0595	NGE2250FG-P2-M0595
680	26.77	NGE2250FG-P-M0680	NGE2250FG-P2-M0680
765	30.12	NGE2250FG-P-M0765	NGE2250FG-P2-M0765
850	33.46	NGE2250FG-P-M0850	NGE2250FG-P2-M0850
935	36.81	NGE2250FG-P-M0935	NGE2250FG-P2-M0935
1020	40.16	NGE2250FG-P-M1020	NGE2250FG-P2-M1020
1105	43.50	NGE2250FG-P-M1105	NGE2250FG-P2-M1105
1190	46.85	NGE2250FG-P-M1190	NGE2250FG-P2-M1190
1275	50.20	NGE2250FG-P-M1275	NGE2250FG-P2-M1275
1360	53.54	NGE2250FG-P-M1360	NGE2250FG-P2-M1360
1445	56.89	NGE2250FG-P-M1445	NGE2250FG-P2-M1445
1530	60.24	NGE2250FG-P-M1530	NGE2250FG-P2-M1530
1615	63.58	NGE2250FG-P-M1615	NGE2250FG-P2-M1615
1700	66.93	NGE2250FG-P-M1700	NGE2250FG-P2-M1700
1785	70.28	NGE2250FG-P-M1785	NGE2250FG-P2-M1785
1870	73.62	NGE2250FG-P-M1870	NGE2250FG-P2-M1870

Other widths available on request.

Chains & sprockets	Wear strips	Side guide brackets & accessories	Levelers	Engineering manual
Modular belts & sprockets	Chain & belt return systems	Frame & structure supports	Bearing supports	
Curves & tracks	Side guide solutions	Miscellaneous products	Equipment	

30360c

25,4 mm (1") 2250 MODULAR BELTS - THICKNESS: 8,7 mm (0.34 in)

www.SystemPlastSmartGuide.com

FLUSH GRID VERSION WITH TWIN POSITIONERS

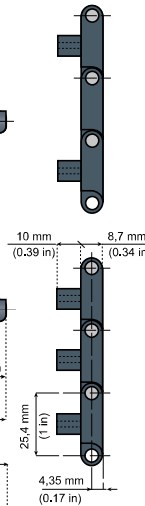
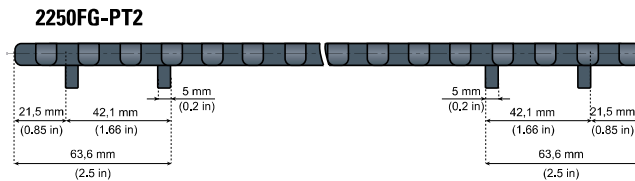
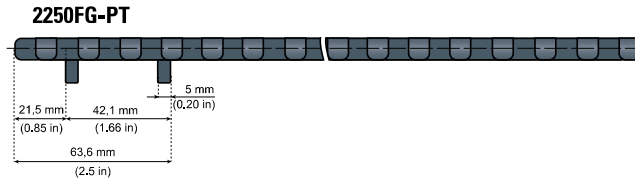

Other versions for 25,4 mm (1") belts:

FT
Flat top



FT
Vacuum



RTC
Roller top



VG
Rubber insert



NG® evo conveyor components made from engineered plastic resin
 Longer wearlife than acetal
 Lower friction than acetal
 Good chemical resistance
 High abrasion resistance
 It meets the requirement for materials as stated by EC1935/2004 and FDA CFR21 norms for direct food contact
 Less dust than with acetal chains
 More.....

Backflex radius:

25 mm (0.98 in)

Max load capacity (LFG):

25000 N/m (1700 lbs/ft.)

Weight: 7,3 Kg/m² (1.48 lbs/ft²)

Pin material: PBT (white)

Open surface: 23%

Standard length:

width ≤ 340 mm (13.39 in): 3,048 m (10 ft.)

width > 340 mm (13.39 in) ≤ 1700 mm (66.93 in): 1,524 m (5 ft.)

width > 1700 mm (66.93 in): on request

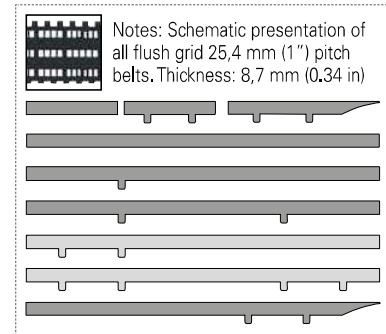

30395a



Information about this product is only available on our Smart Guide® website.

Standard materials

NGE (GREY BLUE)

New Generation®

LFG (GREY)

Low friction acetal resin

materials details:

73563a

WIDTH W		ITEM DESCRIPTION		ITEM DESCRIPTION	
mm	in	NGE (GREY BLUE)	LFG (GREY)	NGE (GREY BLUE)	LFG (GREY)
85	3.35	NGE2250FG-PT-M0085	LFG2250FG-PT-M0085	-	-
170	6.69	NGE2250FG-PT-M0170	LFG2250FG-PT-M0170	NGE2250FG-PT2-M0170	LFG2250FG-PT2-M0170
255	10.04	NGE2250FG-PT-M0255	LFG2250FG-PT-M0255	NGE2250FG-PT2-M0255	LFG2250FG-PT2-M0255
340	13.39	NGE2250FG-PT-M0340	LFG2250FG-PT-M0340	NGE2250FG-PT2-M0340	LFG2250FG-PT2-M0340
425	16.73	NGE2250FG-PT-M0425	LFG2250FG-PT-M0425	NGE2250FG-PT2-M0425	LFG2250FG-PT2-M0425
510	20.08	NGE2250FG-PT-M0510	LFG2250FG-PT-M0510	NGE2250FG-PT2-M0510	LFG2250FG-PT2-M0510
595	23.43	NGE2250FG-PT-M0595	LFG2250FG-PT-M0595	NGE2250FG-PT2-M0595	LFG2250FG-PT2-M0595
680	26.77	NGE2250FG-PT-M0680	LFG2250FG-PT-M0680	NGE2250FG-PT2-M0680	LFG2250FG-PT2-M0680
765	30.12	NGE2250FG-PT-M0765	LFG2250FG-PT-M0765	NGE2250FG-PT2-M0765	LFG2250FG-PT2-M0765
850	33.46	NGE2250FG-PT-M0850	LFG2250FG-PT-M0850	NGE2250FG-PT2-M0850	LFG2250FG-PT2-M0850
935	36.81	NGE2250FG-PT-M0935	LFG2250FG-PT-M0935	NGE2250FG-PT2-M0935	LFG2250FG-PT2-M0935
1020	40.16	NGE2250FG-PT-M1020	LFG2250FG-PT-M1020	NGE2250FG-PT2-M1020	LFG2250FG-PT2-M1020
1105	43.50	NGE2250FG-PT-M1105	LFG2250FG-PT-M1105	NGE2250FG-PT2-M1105	LFG2250FG-PT2-M1105
1190	46.85	NGE2250FG-PT-M1190	LFG2250FG-PT-M1190	NGE2250FG-PT2-M1190	LFG2250FG-PT2-M1190
1275	50.20	NGE2250FG-PT-M1275	LFG2250FG-PT-M1275	NGE2250FG-PT2-M1275	LFG2250FG-PT2-M1275
1360	53.54	NGE2250FG-PT-M1360	LFG2250FG-PT-M1360	NGE2250FG-PT2-M1360	LFG2250FG-PT2-M1360
1445	56.89	NGE2250FG-PT-M1445	LFG2250FG-PT-M1445	NGE2250FG-PT2-M1445	LFG2250FG-PT2-M1445
1530	60.24	NGE2250FG-PT-M1530	LFG2250FG-PT-M1530	NGE2250FG-PT2-M1530	LFG2250FG-PT2-M1530
1615	63.58	NGE2250FG-PT-M1615	LFG2250FG-PT-M1615	NGE2250FG-PT2-M1615	LFG2250FG-PT2-M1615
1700	66.93	NGE2250FG-PT-M1700	LFG2250FG-PT-M1700	NGE2250FG-PT2-M1700	LFG2250FG-PT2-M1700
1785	70.28	NGE2250FG-PT-M1785	LFG2250FG-PT-M1785	NGE2250FG-PT2-M1785	LFG2250FG-PT2-M1785
1870	73.62	NGE2250FG-PT-M1870	LFG2250FG-PT-M1870	NGE2250FG-PT2-M1870	LFG2250FG-PT2-M1870

Other widths available on request.



Chains & sprockets	Wear strips	Side guide brackets & accessories	Levelers	Engineering manual
Modular belts & sprockets	Chain & belt return systems	Frame & structure supports	Bearing supports	
Curves & tracks	Side guide solutions	Miscellaneous products	Equipment	

continue ►

30365a

25,4 mm (1") 2250 MODULAR BELTS WITH FLIGHTS

www.SystemPlastSmartGuide.com

2250 FT



2250 FG



FLAT TOP

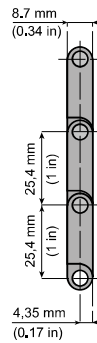
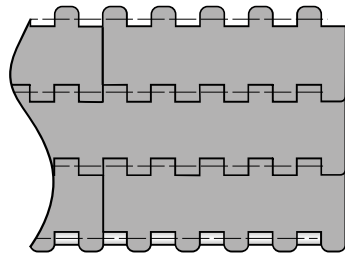

FLUSH GRID

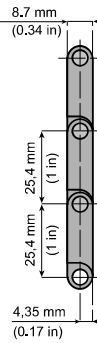
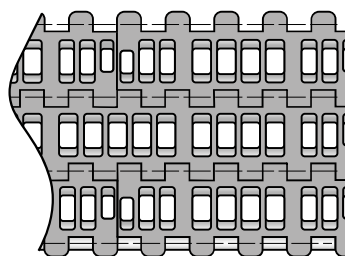

Example modules:

3 in (76,2 mm) height

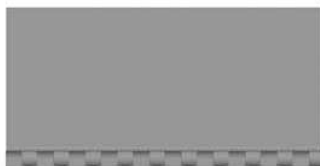

Our 2250 series modular plastic belts can now be equipped with flights to convey products up an incline. The flights can be integrated into flat top or flush grid belts and can be made in different FDA approved materials and in different colors.

2 in (50,8 mm) height



The height of the flights is 2 in, but also 1 in and 3 in height can be molded. The molded quality guarantees a smooth and hygienic product. It is easy to clean.

1 in (25,4 mm) height



17 mm (0.67 in) side indent



In order to facilitate a proper support of the belts in the return part of the conveyor, a belt can be made with side indents on the flights.

34 mm (1.34 in) side indent



The side indent can be 17, 34 or 51 mm with 51 mm being the standard indent. For wider belts it is even possible to have 1, 2 or 3 notches in between the flights.

51 mm (2 in) side indent



The distance between 2 rows of flights can be made as required. You can just indicate the pitch between the rows that carry the flights.

continue ►

Chains & sprockets	Wear strips	Side guide brackets & accessories	Levelers	Engineering manual
Modular belts & sprockets	Chain & belt return systems	Frame & structure supports	Bearing supports	
Curves & tracks	Side guide solutions	Miscellaneous products	Equipment	

3 0 3 6 5 b

25,4 mm (1") 2250 MODULAR BELTS WITH FLIGHTS

www.SystemPlastSmartGuide.com

QUESTIONNAIRE

2250 FT



2250 FG

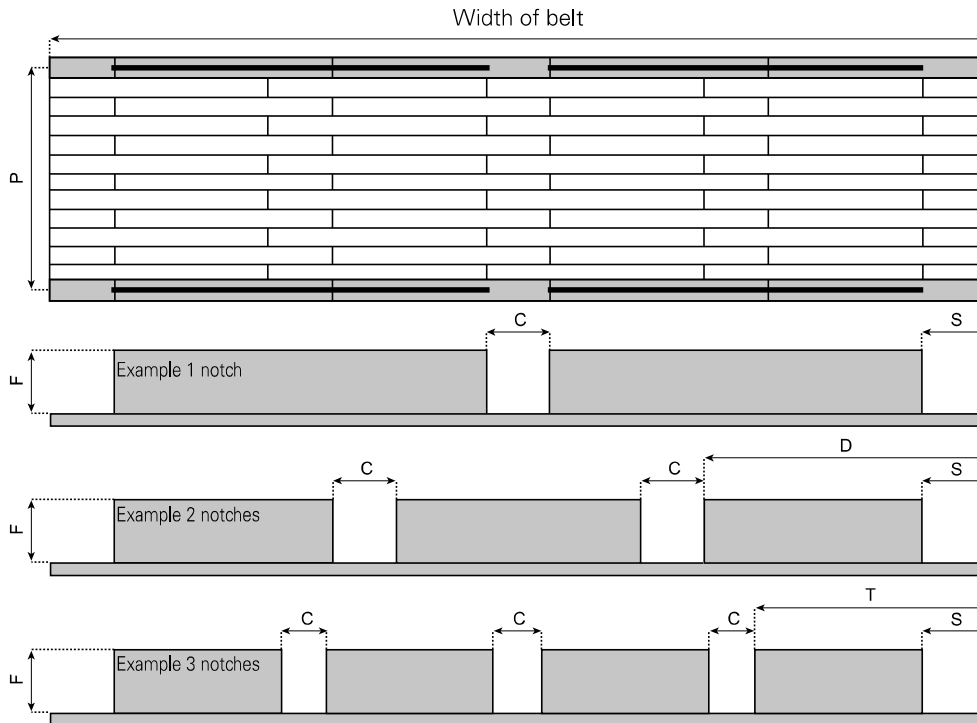

◀ back



Below you see an example of a questionnaire. If you select the belt version and tick the boxes of the dimensions that you require, we know exactly what belt to produce!

QUESTIONNAIRE BELT WITH FLIGHTS				
SERIES	<input type="checkbox"/>	2250		
STYLE	<input type="checkbox"/>	Flat top		
	<input type="checkbox"/>	Flush grid		
WIDTH IN mm	<input type="checkbox"/>	Standard: multiples of 85 mm	<input type="text"/>	
	<input type="checkbox"/>	Special: multiples of 17 mm	<input type="text"/>	
MATERIAL	<input type="checkbox"/>	LFG (POM grey)		<input type="checkbox"/> Different:
	<input type="checkbox"/>	LFW (POM white)		<input type="checkbox"/> Color:
	<input type="checkbox"/>	NGE (grey blue)		
	<input type="checkbox"/>	PPW (PP white)		
HEIGHT OF FLIGHT [F]	<input type="checkbox"/>	Preferred: 2 in (51 mm)		<input type="checkbox"/> 1 in (25 mm)
				<input type="checkbox"/> 3 in (76 mm; maximum)
				<input type="checkbox"/> Special different: <input type="text"/> mm
PITCH OF FLIGHTS [P]		1 row of flights every:	<input type="text"/>	pitch
SIDE INDENT [S]	<input type="checkbox"/>	Standard: no side indent		<input type="checkbox"/> 17 mm
	<input type="checkbox"/>	Standard: 51 mm		<input type="checkbox"/> 34 mm
				<input type="checkbox"/> Special different: <input type="text"/> mm
NOTCH	<input type="checkbox"/>	Standard: no notch		<input type="checkbox"/> Special: 2 notches symmetrical
	<input type="checkbox"/>	Standard: 1 notch in centre		<input type="checkbox"/> Special: 3 notches symmetrical
WIDTH OF NOTCH(ES) [C] IN mm	<input type="checkbox"/>	Standard: multiples of 17 mm	<input type="text"/>	<input type="checkbox"/> Special different: <input type="text"/>
DISTANCE FROM SIDE OF OUTER NOTCH TO SIDE OF BELT IN mm	<input type="checkbox"/>	2 notches, distance D	<input type="text"/>	
	<input type="checkbox"/>	3 notches, distance T	<input type="text"/>	

◀ back

Chains & sprockets	Wear strips	Side guide brackets & accessories	Levelers	Engineering manual
Modular belts & sprockets	Chain & belt return systems	Frame & structure supports	Bearing supports	
Curves & tracks	Side guide solutions	Miscellaneous products	Equipment	



30370a

25,4 mm (1") 2250 MODULAR BELTS - THICKNESS: 8,7 mm (0.34 in)

www.SystemPlastSmartGuide.com

RUBBER INSERT EVERY PITCH

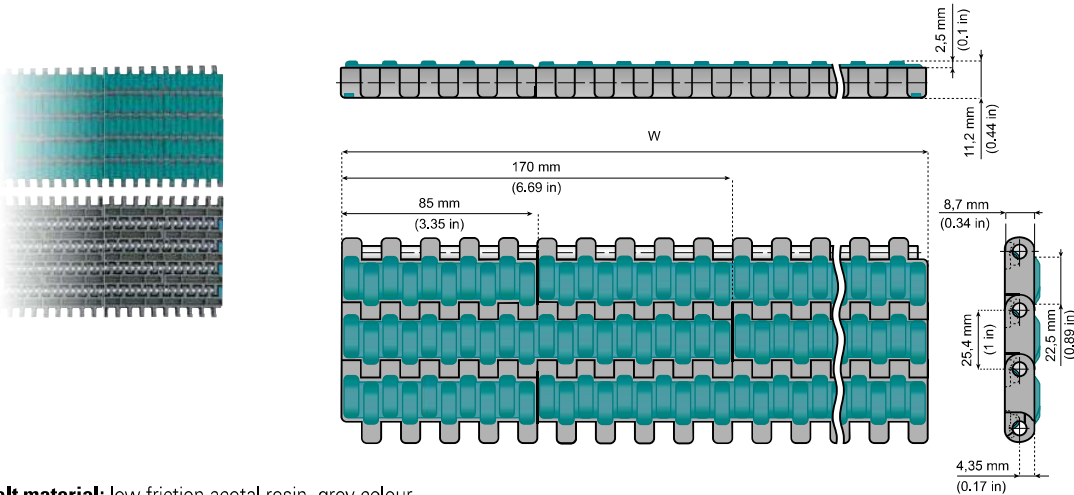

Belt material: low friction acetal resin, grey colour
Rubber material: thermoplastic rubber, waterblue colour, 70 shore A.
Backflex radius: 30 mm (1.18 in)
Max load capacity: 25000 N/m (1700 lbs/ft.)
Pin material: PBT (white)
Standard length:
width ≤ 340 mm (13.39 in): 3,048 m (10 ft.)
width > 340 mm (13.39 in) ≤ 1700 mm (66.93 in): 1,524 m (5 ft.)
width > 1700 mm (66.93 in): on request

VG 2250
Insert every pitch

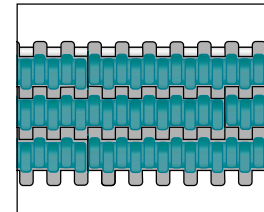

Weight:
8,7 Kg/m² (1.77 lbs/ft.²)

30395a

Standard material

LFG (GREY)
Low friction acetal resin

materials details:
73563a

TPR (WATER BLUE)
Thermoplastic rubber

materials details:
73570a

Other versions for 25,4 mm (1") belts:

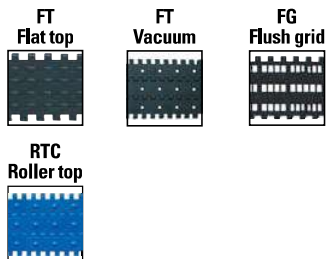

Information about this product is only available on our Smart Guide® website.

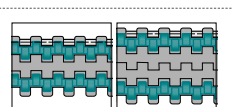

For insert every 2nd or 3th pitch, go to:

30370b

Notes: Schematic presentation of all VG rubber insert 25,4 mm (1") pitch belts. Thickness: 8,7 mm (0,34 in)

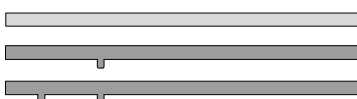

Also available with side indent. Go to:

30380a

WIDTH W		ITEM DESCRIPTION
mm	in	
85	3,35	LFG2250FT-M0085VG
170	6,69	LFG2250FT-M0170VG
255	10,04	LFG2250FT-M0255VG
340	13,39	LFG2250FT-M0340VG
425	16,73	LFG2250FT-M0425VG
510	20,08	LFG2250FT-M0510VG
595	23,43	LFG2250FT-M0595VG
680	26,77	LFG2250FT-M0680VG
765	30,12	LFG2250FT-M0765VG
850	33,46	LFG2250FT-M0850VG
935	36,81	LFG2250FT-M0935VG
1020	40,16	LFG2250FT-M1020VG
1105	43,50	LFG2250FT-M1105VG
1190	46,85	LFG2250FT-M1190VG
1275	50,20	LFG2250FT-M1275VG
1360	53,54	LFG2250FT-M1360VG
1445	56,89	LFG2250FT-M1445VG
1530	60,24	LFG2250FT-M1530VG
1615	63,58	LFG2250FT-M1615VG
1700	66,93	LFG2250FT-M1700VG
1785	70,28	LFG2250FT-M1785VG
1870	73,62	LFG2250FT-M1870VG
1955	76,97	LFG2250FT-M1955VG
2040	80,31	LFG2250FT-M2040VG

Other widths available on request.

Chains & sprockets	Wear strips	Side guide brackets & accessories	Levelers	Engineering manual
Modular belts & sprockets	Chain & belt return systems	Frame & structure supports	Bearing supports	
Curves & tracks	Side guide solutions	Miscellaneous products	Equipment	



30370b

25,4 mm (1") 2250 MODULAR BELTS - THICKNESS: 8,7 mm (0.34 in)

www.SystemPlastSmartGuide.com

RUBBER INSERT EVERY 2nd & 3th PITCH

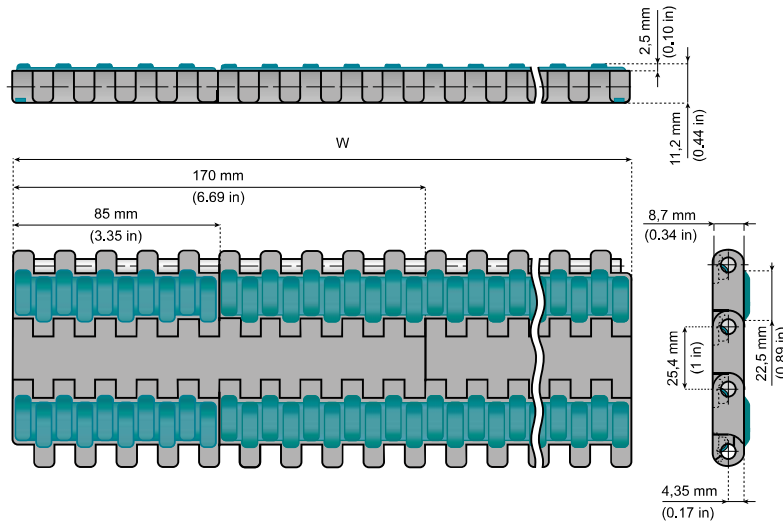
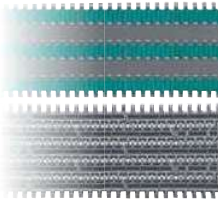

Belt material: low friction acetal resin, grey colour
Rubber material: thermoplastic rubber, waterblue colour, 70 shore A.
Backflex radius: 30 mm (1.18 in)
Max load capacity: 25000 N/m (1700 lbs/ft.)
Pin material: PBT (white)
Standard length:
width ≤ 340 mm (13.39 in): 3,048 m (10 ft.)
width > 340 mm (13.39 in) ≤ 1700 mm (66.93 in): 1,524 m (5 ft.) width > 1700 mm (66.93 in): on request

30395a

VG2 2250
Insert every 2nd pitch

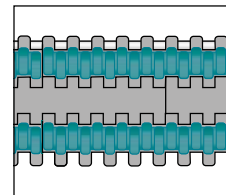

Weight:
8,1 Kg/m² (1.66 lbs/ft²)

VG3 2250
Insert every 3th pitch

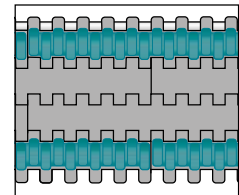

Weight:
7,8 Kg/m² (1.59 lbs/ft²)

Other versions for 25,4 mm (1") belts:

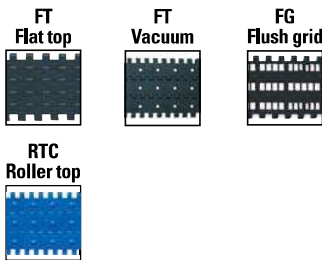

Notes: Schematic presentation of all VG rubber insert 25,4 mm (1") pitch belts. Thickness: 8,7 mm (0.34 in)



Also available with side indent. Go to:

30380a

For insert every pitch, go to:

30370a

Information about this product is only available on our Smart Guide® website.

Standard material

LFG (GREY)

Low friction acetal resin

materials details:

73563a

TPR (WATER BLUE)

Thermoplastic rubber

materials details:

73570a

WIDTH W		ITEM DESCRIPTION	ITEM DESCRIPTION
mm	in		
85	3.35	LFG2250FT-M0085VG-2	LFG2250FT-M0085VG-3
170	6.69	LFG2250FT-M0170VG-2	LFG2250FT-M0170VG-3
255	10.04	LFG2250FT-M0255VG-2	LFG2250FT-M0255VG-3
340	13.39	LFG2250FT-M0340VG-2	LFG2250FT-M0340VG-3
425	16.73	LFG2250FT-M0425VG-2	LFG2250FT-M0425VG-3
510	20.08	LFG2250FT-M0510VG-2	LFG2250FT-M0510VG-3
595	23.43	LFG2250FT-M0595VG-2	LFG2250FT-M0595VG-3
680	26.77	LFG2250FT-M0680VG-2	LFG2250FT-M0680VG-3
765	30.12	LFG2250FT-M0765VG-2	LFG2250FT-M0765VG-3
850	33.46	LFG2250FT-M0850VG-2	LFG2250FT-M0850VG-3
935	36.81	LFG2250FT-M0935VG-2	LFG2250FT-M0935VG-3
1020	40.16	LFG2250FT-M1020VG-2	LFG2250FT-M1020VG-3
1105	43.50	LFG2250FT-M1105VG-2	LFG2250FT-M1105VG-3
1190	46.85	LFG2250FT-M1190VG-2	LFG2250FT-M1190VG-3
1275	50.20	LFG2250FT-M1275VG-2	LFG2250FT-M1275VG-3
1360	53.54	LFG2250FT-M1360VG-2	LFG2250FT-M1360VG-3
1445	56.89	LFG2250FT-M1445VG-2	LFG2250FT-M1445VG-3
1530	60.24	LFG2250FT-M1530VG-2	LFG2250FT-M1530VG-3
1615	63.58	LFG2250FT-M1615VG-2	LFG2250FT-M1615VG-3
1700	66.93	LFG2250FT-M1700VG-2	LFG2250FT-M1700VG-3
1785	70.28	LFG2250FT-M1785VG-2	LFG2250FT-M1785VG-3
1870	73.62	LFG2250FT-M1870VG-2	LFG2250FT-M1870VG-3
1955	76.97	LFG2250FT-M1955VG-2	LFG2250FT-M1955VG-3
2040	80.31	LFG2250FT-M2040VG-2	LFG2250FT-M2040VG-3

Other widths available on request.

Chains & sprockets	Wear strips	Side guide brackets & accessories	Levelers	Engineering manual
Modular belts & sprockets	Chain & belt return systems	Frame & structure supports	Bearing supports	
Curves & tracks	Side guide solutions	Miscellaneous products	Equipment	

30370c

25,4 mm (1") 2250 MODULAR BELTS - THICKNESS: 8,7 mm (0.34 in)

www.SystemPlastSmartGuide.com

VERSIONS WITH POSITIONERS / RUBBER INSERTS

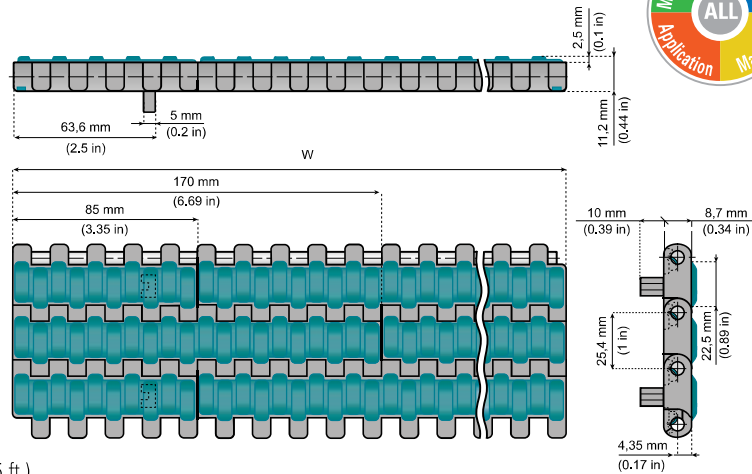
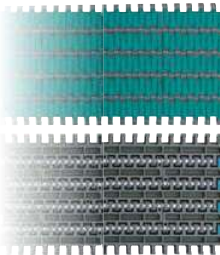

Belt material: low friction acetal resin, grey colour

Rubber material: thermoplastic rubber, waterblue colour, 70 shore A.

Backflex radius: 30 mm (1.18 in)

Max load capacity: 25000 N/m (1700 lbs/ft.)

Pin material: PBT (white)

Standard length:

width ≤ 340 mm (13.39 in): 3,048 m (10 ft.)

width > 340 mm (13.39 in) ≤ 1700 mm (66.93 in): 1,524 m (5 ft.)

width > 1700 mm (66.93 in): on request

Standard material

LFG (GREY)

Low friction acetal resin

materials details:

73563a

TPR (WATER BLUE)

Thermoplastic rubber

materials details:

73570a



Information about this product is only available on our Smart Guide® website.



30395a

VG 2250 P1 Insert every pitch

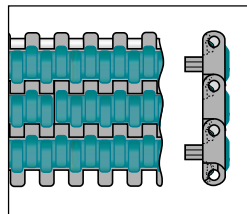

Weight:
8,7 Kg/m² (1.77 lbs/ft.²)

VG2 2250 P1 Insert every 2nd pitch

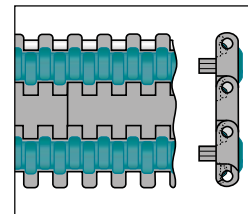

Weight:
8,1 Kg/m² (1.66 lbs/ft.²)

VG3 2250 P1 Insert every 3th pitch

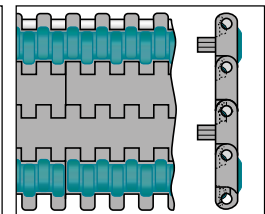

Weight:
7,8 Kg/m² (1.59 lbs/ft.²)

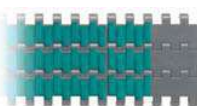

Also available with side indent. Go to:

30380a

Other versions for 25,4 mm (1") belts:

FT

Flat top



FT

Vacuum



FG

Flush grid



RTC

Roller top



Notes: Schematic presentation of all VG rubber insert 25,4 mm (1") belts. Thickness: 8,7 mm (0,34 in)

WIDTH W		ITEM DESCRIPTION	ITEM DESCRIPTION	ITEM DESCRIPTION
mm	in			
85	3.35	LFG2250FT-P-M0085VG	LFG2250FT-P-M0085VG-2	LFG2250FT-P-M0085VG-3
170	6.69	LFG2250FT-P-M0170VG	LFG2250FT-P-M0170VG-2	LFG2250FT-P-M0170VG-3
255	10.04	LFG2250FT-P-M0255VG	LFG2250FT-P-M0255VG-2	LFG2250FT-P-M0255VG-3
340	13.39	LFG2250FT-P-M0340VG	LFG2250FT-P-M0340VG-2	LFG2250FT-P-M0340VG-3
425	16.73	LFG2250FT-P-M0425VG	LFG2250FT-P-M0425VG-2	LFG2250FT-P-M0425VG-3
510	20.08	LFG2250FT-P-M0510VG	LFG2250FT-P-M0510VG-2	LFG2250FT-P-M0510VG-3
595	23.43	LFG2250FT-P-M0595VG	LFG2250FT-P-M0595VG-2	LFG2250FT-P-M0595VG-3
680	26.77	LFG2250FT-P-M0680VG	LFG2250FT-P-M0680VG-2	LFG2250FT-P-M0680VG-3
765	30.12	LFG2250FT-P-M0765VG	LFG2250FT-P-M0765VG-2	LFG2250FT-P-M0765VG-3
850	33.46	LFG2250FT-P-M0850VG	LFG2250FT-P-M0850VG-2	LFG2250FT-P-M0850VG-3
935	36.81	LFG2250FT-P-M0935VG	LFG2250FT-P-M0935VG-2	LFG2250FT-P-M0935VG-3
1020	40.16	LFG2250FT-P-M1020VG	LFG2250FT-P-M1020VG-2	LFG2250FT-P-M1020VG-3
1105	43.50	LFG2250FT-P-M1105VG	LFG2250FT-P-M1105VG-2	LFG2250FT-P-M1105VG-3
1190	46.85	LFG2250FT-P-M1190VG	LFG2250FT-P-M1190VG-2	LFG2250FT-P-M1190VG-3
1275	50.20	LFG2250FT-P-M1275VG	LFG2250FT-P-M1275VG-2	LFG2250FT-P-M1275VG-3
1360	53.54	LFG2250FT-P-M1360VG	LFG2250FT-P-M1360VG-2	LFG2250FT-P-M1360VG-3
1445	56.89	LFG2250FT-P-M1445VG	LFG2250FT-P-M1445VG-2	LFG2250FT-P-M1445VG-3
1530	60.24	LFG2250FT-P-M1530VG	LFG2250FT-P-M1530VG-2	LFG2250FT-P-M1530VG-3
1615	63.58	LFG2250FT-P-M1615VG	LFG2250FT-P-M1615VG-2	LFG2250FT-P-M1615VG-3
1700	66.93	LFG2250FT-P-M1700VG	LFG2250FT-P-M1700VG-2	LFG2250FT-P-M1700VG-3
1785	70.28	LFG2250FT-P-M1785VG	LFG2250FT-P-M1785VG-2	LFG2250FT-P-M1785VG-3
1870	73.62	LFG2250FT-P-M1870VG	LFG2250FT-P-M1870VG-2	LFG2250FT-P-M1870VG-3
1955	76.97	LFG2250FT-P-M1955VG	LFG2250FT-P-M1955VG-2	LFG2250FT-P-M1955VG-3
2040	80.31	LFG2250FT-P-M2040VG	LFG2250FT-P-M2040VG-2	LFG2250FT-P-M2040VG-3

Other widths available on request.



Chains & sprockets	Wear strips	Side guide brackets & accessories	Levelers	Engineering manual
Modular belts & sprockets	Chain & belt return systems	Frame & structure supports	Bearing supports	
Curves & tracks	Side guide solutions	Miscellaneous products	Equipment	

30370d

25,4 mm (1") 2250 MODULAR BELTS - THICKNESS: 8,7 mm (0.34 in)

www.SystemPlastSmartGuide.com

VERSIONS WITH TWIN POSITIONERS / RUBBER INSERT

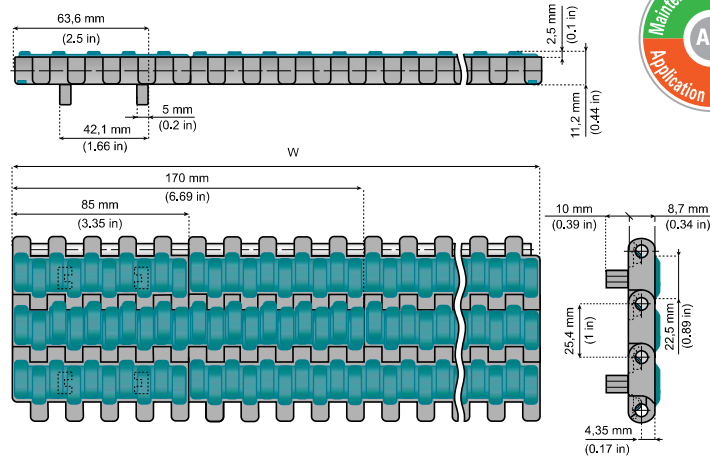
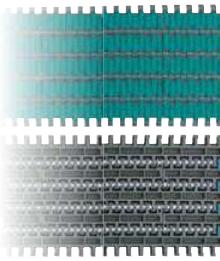

Belt material: low friction acetal resin, grey colour

Rubber material: thermoplastic rubber, waterblue colour, 70 shore A.

Backflex radius: 30 mm (1.18 in)

Max load capacity: 25000 N/m (1700 lbs/ft.)

Pin material: PBT (white)

Standard length:

width ≤ 340 mm (13.39 in): 3,048 m (10 ft.)

width > 340 mm (13.39 in) ≤ 1700 mm (66.93 in): 1,524 m (5 ft.)

width > 1700 mm (66.93 in): on request



Information about this product is only available on our Smart Guide® website.

Standard material

LFG (GREY)

Low friction acetal resin

materials details:

73563a

TPR (WATER BLUE)

Thermoplastic rubber

materials details:

73570a

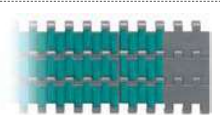

Also available with side indent. Go to:

30380a

Other versions for 25,4 mm (1") belts:

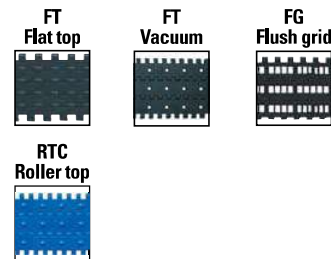

Notes: Schematic presentation of all VG rubber insert 25,4 mm (1") pitch belts. Thickness: 8,7 mm (0.34 in)

VG 2250 P2 Insert every pitch

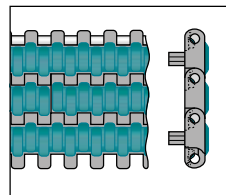

Weight:

8,7 Kg/m² (1.77 lbs/ft.²)

VG2 2250 P2 Insert every 2nd pitch

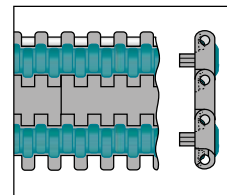

Weight:

8,1 Kg/m² (1.66 lbs/ft.²)

VG3 2250 P2 Insert every 3th pitch

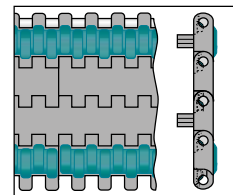

Weight:

7,8 Kg/m² (1.59 lbs/ft.²)

WIDTH W		ITEM DESCRIPTION	ITEM DESCRIPTION	ITEM DESCRIPTION
mm	in			
85	3.35	LFG2250FT-PT-M0085VG	LFG2250FT-PT-M0085VG-2	LFG2250FT-PT-M0085VG-3
170	6.69	LFG2250FT-PT-M0170VG	LFG2250FT-PT-M0170VG-2	LFG2250FT-PT-M0170VG-3
255	10.04	LFG2250FT-PT-M0255VG	LFG2250FT-PT-M0255VG-2	LFG2250FT-PT-M0255VG-3
340	13.39	LFG2250FT-PT-M0340VG	LFG2250FT-PT-M0340VG-2	LFG2250FT-PT-M0340VG-3
425	16.73	LFG2250FT-PT-M0425VG	LFG2250FT-PT-M0425VG-2	LFG2250FT-PT-M0425VG-3
510	20.08	LFG2250FT-PT-M0510VG	LFG2250FT-PT-M0510VG-2	LFG2250FT-PT-M0510VG-3
595	23.43	LFG2250FT-PT-M0595VG	LFG2250FT-PT-M0595VG-2	LFG2250FT-PT-M0595VG-3
680	26.77	LFG2250FT-PT-M0680VG	LFG2250FT-PT-M0680VG-2	LFG2250FT-PT-M0680VG-3
765	30.12	LFG2250FT-PT-M0765VG	LFG2250FT-PT-M0765VG-2	LFG2250FT-PT-M0765VG-3
850	33.46	LFG2250FT-PT-M0850VG	LFG2250FT-PT-M0850VG-2	LFG2250FT-PT-M0850VG-3
935	36.81	LFG2250FT-PT-M0935VG	LFG2250FT-PT-M0935VG-2	LFG2250FT-PT-M0935VG-3
1020	40.16	LFG2250FT-PT-M1020VG	LFG2250FT-PT-M1020VG-2	LFG2250FT-PT-M1020VG-3
1105	43.50	LFG2250FT-PT-M1105VG	LFG2250FT-PT-M1105VG-2	LFG2250FT-PT-M1105VG-3
1190	46.85	LFG2250FT-PT-M1190VG	LFG2250FT-PT-M1190VG-2	LFG2250FT-PT-M1190VG-3
1275	50.20	LFG2250FT-PT-M1275VG	LFG2250FT-PT-M1275VG-2	LFG2250FT-PT-M1275VG-3
1360	53.54	LFG2250FT-PT-M1360VG	LFG2250FT-PT-M1360VG-2	LFG2250FT-PT-M1360VG-3
1445	56.89	LFG2250FT-PT-M1445VG	LFG2250FT-PT-M1445VG-2	LFG2250FT-PT-M1445VG-3
1530	60.24	LFG2250FT-PT-M1530VG	LFG2250FT-PT-M1530VG-2	LFG2250FT-PT-M1530VG-3
1615	63.58	LFG2250FT-PT-M1615VG	LFG2250FT-PT-M1615VG-2	LFG2250FT-PT-M1615VG-3
1700	66.93	LFG2250FT-PT-M1700VG	LFG2250FT-PT-M1700VG-2	LFG2250FT-PT-M1700VG-3
1785	70.28	LFG2250FT-PT-M1785VG	LFG2250FT-PT-M1785VG-2	LFG2250FT-PT-M1785VG-3
1870	73.62	LFG2250FT-PT-M1870VG	LFG2250FT-PT-M1870VG-2	LFG2250FT-PT-M1870VG-3
1955	76.97	LFG2250FT-PT-M1955VG	LFG2250FT-PT-M1955VG-2	LFG2250FT-PT-M1955VG-3
2040	80.31	LFG2250FT-PT-M2040VG	LFG2250FT-PT-M2040VG-2	LFG2250FT-PT-M2040VG-3

Other widths available on request.



Chains & sprockets	Wear strips	Side guide brackets & accessories	Levelers	Engineering manual
Modular belts & sprockets	Chain & belt return systems	Frame & structure supports	Bearing supports	
Curves & tracks	Side guide solutions	Miscellaneous products	Equipment	

30380a

25,4 mm (1") 2250 MODULAR BELTS - THICKNESS: 8,7 mm (0.34 in)

www.SystemPlastSmartGuide.com

RUBBER INSERT EVERY PITCH WITH SIDE INDENT

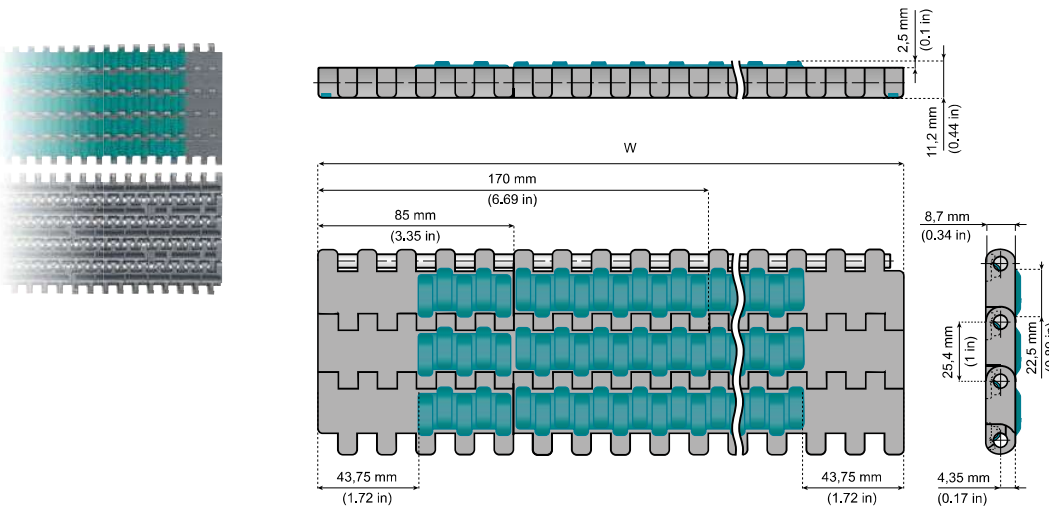

Version with side indent

Belt material: low friction acetal resin, grey colour

Rubber material: thermoplastic rubber, waterblue colour, 70 shore A.

Backflex radius: 30 mm (1.18 in)

Max load capacity: 25000 N/m (1700 lbs/ft.)

Pin material: PBT (white)

Standard length:

width ≤ 340 mm (13.39 in): 3,048 m (10 ft.)

width > 340 mm (13.39 in) ≤ 1700 mm (66.93 in): 1,524 m (5 ft.)

width > 1700 mm (66.93 in): on request

VGS 2250

Insert every pitch

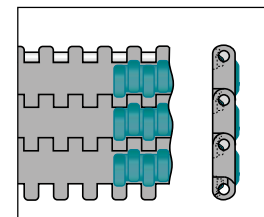

Weight:

8,7 Kg/m² (1.77 lbs/ft².)

30395a

Standard material

LFG (GREY)

Low friction acetal resin

materials details:

73563a

TPR (WATER BLUE)

Thermoplastic rubber

materials details:

73570a



Information about this product is only available on our Smart Guide® website.

Other versions for 25,4 mm (1") belts:

FT Flat top



FT Vacuum



FG Flush grid



RTC Roller top

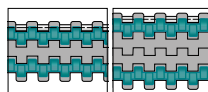

For insert every 2nd or 3th pitch, go to:

30380b

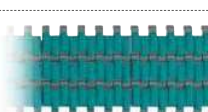

For full width rubber surface. Go to:

30370a



Notes: Schematic presentation of all VG rubber insert 25,4 mm (1") pitch belts. Thickness: 8,7 mm (0.34 in)

WIDTH W		ITEM DESCRIPTION
mm	in	
255	10.04	LFG2250FT-M0255VGS
340	13.39	LFG2250FT-M0340VGS
425	16.73	LFG2250FT-M0425VGS
510	20.08	LFG2250FT-M0510VGS
595	23.43	LFG2250FT-M0595VGS
680	26.77	LFG2250FT-M0680VGS
765	30.12	LFG2250FT-M0765VGS
850	33.46	LFG2250FT-M0850VGS
935	36.81	LFG2250FT-M0935VGS
1020	40.16	LFG2250FT-M1020VGS
1105	43.50	LFG2250FT-M1105VGS
1190	46.85	LFG2250FT-M1190VGS
1275	50.20	LFG2250FT-M1275VGS
1360	53.54	LFG2250FT-M1360VGS
1445	56.89	LFG2250FT-M1445VGS
1530	60.24	LFG2250FT-M1530VGS
1615	63.58	LFG2250FT-M1615VGS
1700	66.93	LFG2250FT-M1700VGS
1785	70.28	LFG2250FT-M1785VGS
1870	73.62	LFG2250FT-M1870VGS
1955	76.97	LFG2250FT-M1955VGS
2040	80.31	LFG2250FT-M2040VGS

Other widths available on request.



Chains & sprockets	Wear strips	Side guide brackets & accessories	Levelers	Engineering manual
Modular belts & sprockets	Chain & belt return systems	Frame & structure supports	Bearing supports	
Curves & tracks	Side guide solutions	Miscellaneous products	Equipment	

30380b

25,4 mm (1") 2250 MODULAR BELTS - THICKNESS: 8,7 mm (0.34 in)

www.SystemPlastSmartGuide.com

RUBBER INSERT EVERY 2nd & 3th PITCH WITH SIDE INDENT

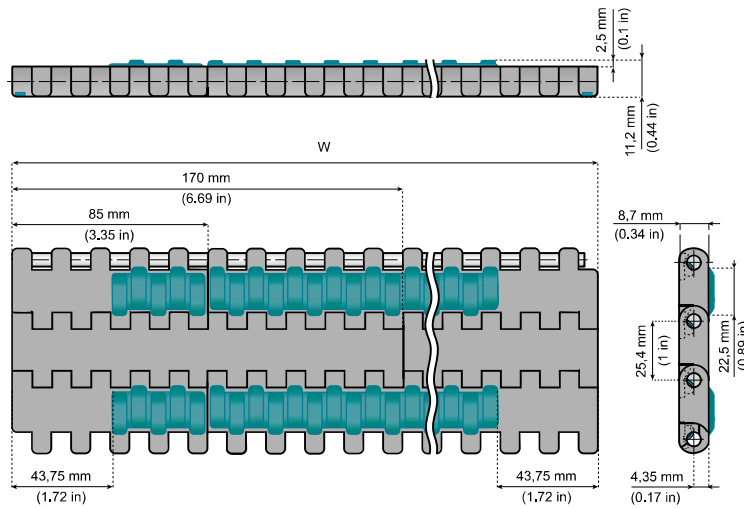

Version with side indent

Belt material: low friction acetal resin, grey colour

Rubber material: thermoplastic rubber, waterblue colour, 70 shore A.

Backflex radius: 30 mm (1.18 in)

Max load capacity: 25000 N/m (1700 lbs/ft.)

Pin material: PBT (white)

Standard length:

width ≤ 340 mm (13.39 in): 3,048 m (10 ft.)

width > 340 mm (13.39 in) ≤ 1700 mm (66.93 in): 1,524 m (5 ft.)

width > 1700 mm (66.93 in): on request

30395a

Standard material

LFG (GREY)

Low friction acetal resin

materials details:

73563a

TPR (WATER BLUE)

Thermoplastic rubber

materials details:

73570a



Information about this product is only available on our Smart Guide® website.

Other versions for 25,4 mm (1") belts:

FT
Flat top



FT
Vacuum



FG
Flush grid



RTC
Roller top



Notes: Schematic presentation of all VG rubber insert 25,4 mm (1") pitch belts. Thickness: 8,7 mm (0.34 in)

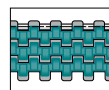

For every insert, go to:

30380a

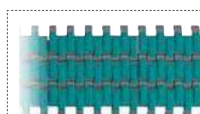

For full width rubber surface. Go to

30370a

VGS2 2250
Insert every 2nd pitch

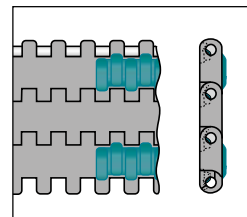

Weight:

8,1 Kg/m² (1.66 lbs/ft².)

VGS3 2250
Insert every 3th pitch

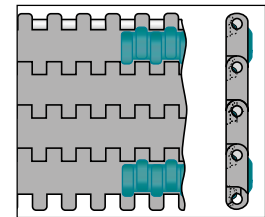

Weight:

7,8 Kg/m² (1.59 lbs/ft².)

WIDTH W		ITEM DESCRIPTION	ITEM DESCRIPTION
mm	in		
170	6.69	LFG2250FT-M0170VGS-2	LFG2250FT-M0170VGS-3
255	10.04	LFG2250FT-M0255VGS-2	LFG2250FT-M0255VGS-3
340	13.39	LFG2250FT-M0340VGS-2	LFG2250FT-M0340VGS-3
425	16.73	LFG2250FT-M0425VGS-2	LFG2250FT-M0425VGS-3
510	20.08	LFG2250FT-M0510VGS-2	LFG2250FT-M0510VGS-3
595	23.43	LFG2250FT-M0595VGS-2	LFG2250FT-M0595VGS-3
680	26.77	LFG2250FT-M0680VGS-2	LFG2250FT-M0680VGS-3
765	30.12	LFG2250FT-M0765VGS-2	LFG2250FT-M0765VGS-3
850	33.46	LFG2250FT-M0850VGS-2	LFG2250FT-M0850VGS-3
935	36.81	LFG2250FT-M0935VGS-2	LFG2250FT-M0935VGS-3
1020	40.16	LFG2250FT-M1020VGS-2	LFG2250FT-M1020VGS-3
1105	43.50	LFG2250FT-M1105VGS-2	LFG2250FT-M1105VGS-3
1190	46.85	LFG2250FT-M1190VGS-2	LFG2250FT-M1190VGS-3
1275	50.20	LFG2250FT-M1275VGS-2	LFG2250FT-M1275VGS-3
1360	53.54	LFG2250FT-M1360VGS-2	LFG2250FT-M1360VGS-3
1445	56.89	LFG2250FT-M1445VGS-2	LFG2250FT-M1445VGS-3
1530	60.24	LFG2250FT-M1530VGS-2	LFG2250FT-M1530VGS-3
1615	63.58	LFG2250FT-M1615VGS-2	LFG2250FT-M1615VGS-3
1700	66.93	LFG2250FT-M1700VGS-2	LFG2250FT-M1700VGS-3
1785	70.28	LFG2250FT-M1785VGS-2	LFG2250FT-M1785VGS-3
1870	73.62	LFG2250FT-M1870VGS-2	LFG2250FT-M1870VGS-3
1955	76.97	LFG2250FT-M1955VGS-2	LFG2250FT-M1955VGS-3
2040	80.31	LFG2250FT-M2040VGS-2	LFG2250FT-M2040VGS-3

Other widths available on request.



Chains & sprockets	Wear strips	Side guide brackets & accessories	Levelers	Engineering manual
Modular belts & sprockets	Chain & belt return systems	Frame & structure supports	Bearing supports	
Curves & tracks	Side guide solutions	Miscellaneous products	Equipment	

30395a

www.SystemPlastSmartGuide.com

DRIVE AND RETURN SPROCKETS

FOR BELTS 2250 - 2253FT - 2253RTC

Notes:

- Sprockets with single keyway can be used for belt widths up to 680 mm (27-in) and temperature differences of maximum 30°C (86°F).

- For wider belts or bigger temperature differences, sprockets with square bores or round bore with double keyway have to be used.

Drive sprockets are manufactured for a tight fit on the shaft.

To order single keyway sprockets capable of floating freely on the shaft, just add the letter "P" (=plus) to the existing Item description.

For example, item description **2250-14R30M-DPS**

Z	Ø OD mm	Ø P mm	S mm
12	98	98,14	44,0
14	113	114,18	52,0
15	122	122,2	56,7
16	129	130,2	60,0
18	145	146,27	68,5
20	162	162,37	76,5

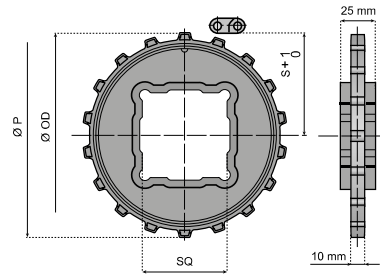

OPTIMUM CHOICE FOR 2253RTC AND 2253FT SERIES BELT CAN BE USED FOR 2250 SERIE AS WELL

SPROCKETS FOR BELTS SERIES 2253RTC - 2253FT - 2250

Z	MOLDED DRIVE SPROCKETS SQUARE BORE ONE PIECE - FLOATING	
	Ø 40X40	Ø 60X60
12	2253-12S40M-D	-
15	2253-15S40M-D	2253-15S60M-D
18	2253-18S40M-D	2253-18S60M-D

Material: reinforced polyamide (grey).

New design 30995a

Features:

- New design with snap-assembly system included.
- Very high strength.
- Split versions: quick and easy replacement.
- Foolproof design.
- Excellent wear and chemical resistance.
- Recyclable.

SPROCKETS FOR BELTS SERIES 2250

Z	MOLDED DRIVE SPROCKETS - SPLIT FIXED		
	Ø 30	Ø 35	Ø 40
14	2250-14R30M-DS	2250-14R35M-DS	2250-14R40M-DS
16	2250-16R30M-DS	2250-16R35M-DS	2250-16R40M-DS
18	2250-18R30M-DS	2250-18R35M-DS	2250-18R40M-DS
20	2250-20R30M-DS	2250-20R35M-DS	2250-20R40M-DS

Z	MOLDED RETURN SPROCKETS - SPLIT		
	Ø 30	Ø 35	Ø 40
14	2250-14R30M-RS	2250-14R35M-RS	2250-14R40M-RS
16	2250-16R30M-RS	2250-16R35M-RS	2250-16R40M-RS
18	2250-18R30M-RS	2250-18R35M-RS	2250-18R40M-RS
20	2250-20R30M-RS	2250-20R35M-RS	2250-20R40M-RS

Z	MOLDED DRIVE SPROCKETS SQUARE BORE - SPLIT FLOATING	
	Ø 30X30	Ø 40X40
14	2250-14S30M-DS	-
16	2250-16S30M-DS	2250-16S40M-DS
18	2250-18S30M-DS	2250-18S40M-DS
20	2250-20S30M-DS	2250-20S40M-DS

Material: reinforced polyamide (black), screws in stainless steel, nuts in nickel plated brass.

Note: These sprockets cannot be used for belt type 2253RTC and 2253FT.



Information about this product is only available on our Smart Guide® website.



See also the sprockets and idler wheels:

30395b **30395c**



See belts 1" Pitch (25,4 mm):

30300a

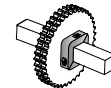

Set collars, go to:

54630a

TO BE USED WITH 2250 SERIES BELTS ONLY!

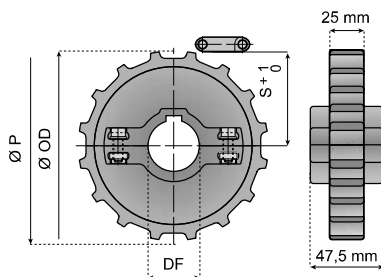

Chains & sprockets	Wear strips	Side guide brackets & accessories	Levelers	Engineering manual
Modular belts & sprockets	Chain & belt return systems	Frame & structure supports	Bearing supports	
Curves & tracks	Side guide solutions	Miscellaneous products	Equipment	

3 0 3 9 5 b

DRIVE AND RETURN SPROCKETS

www.SystemPlastSmartGuide.com

FOR BELT 2250



Note:

- Sprockets with single keyway can be used for belt widths up to 680 mm (27-in) and temperature differences of maximum 30°C (86°F).
- For wider belts or bigger temperature differences, sprockets with square bores or round bore with double keyway have to be used. Drive sprockets are manufactured for a tight fit on the shaft. To order single keyway sprockets capable of floating freely on the shaft, just add the letter "P" (=plus) to the existing Item description. For example, Item description: **2250-14R30M-DPS**

New design

3 0 9 9 0 a

Features:

- Very high strength.
- Split versions: quick and easy replacement.
- Foolproof design.
- Completely closed structure, easy to clean and to disinfect.
- Excellent wear and chemical resistance.
- Recyclable.

Z	Ø OD mm	Ø P mm	S mm
12	96,9	97,75	44,0
14	113,1	113,7	52,1
16	129,4	129,68	60,2
18	145,4	145,7	68,4
20	161,6	161,73	76,5

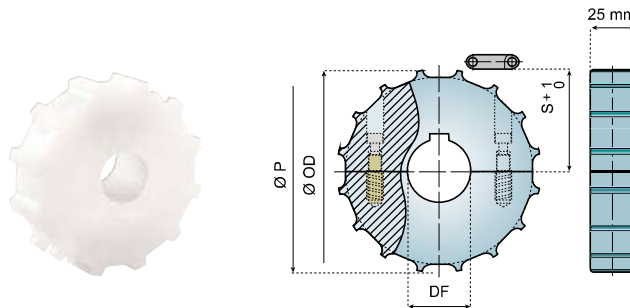

NOT SUITABLE FOR 2253 SERIES BELTS !

SPROCKETS FOR BELTS SERIES 2250

MACHINED DRIVE SPROCKETS - SPLIT FIXED					
Z	Ø 18* (R18M) Ø 23* (R23M)	Ø 25	Ø 30	Ø 35	Ø 40
ITEM DESCRIPTION					
12	-	2250-12R25M-DMS	2250-12R30M-DMS	2250-12R35M-DMS	2250-12R40M-DMS
14	-	2250-14R25M-DMS	2250-14R30M-DMS	2250-14R35M-DMS	2250-14R40M-DMS
16	-	2250-16R25M-DMS	2250-16R30M-DMS	2250-16R35M-DMS	2250-16R40M-DMS
18	-	2250-18R25M-DMS	2250-18R30M-DMS	2250-18R35M-DMS	2250-18R40M-DMS
20	-	2250-20R25M-DMS	2250-20R30M-DMS	2250-20R35M-DMS	2250-20R40M-DMS
MACHINED RETURN SPROCKETS - SPLIT					
12	2250-12R18M-RMS	2250-12R25M-RMS	2250-12R30M-RMS	2250-12R35M-RMS	2250-12R40M-RMS
14	2250-14R23M-RMS	2250-14R25M-RMS	2250-14R30M-RMS	2250-14R35M-RMS	2250-14R40M-RMS
16	2250-16R23M-RMS	2250-16R25M-RMS	2250-16R30M-RMS	2250-16R35M-RMS	2250-16R40M-RMS
18	2250-18R23M-RMS	2250-18R25M-RMS	2250-18R30M-RMS	2250-18R35M-RMS	2250-18R40M-RMS
20	2250-20R23M-RMS	2250-20R25M-RMS	2250-20R30M-RMS	2250-20R35M-RMS	2250-20R40M-RMS

Material: polyamide (natural white), screws in stainless steel, bushings in brass. *Plain bore

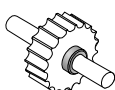

Set collars, go to:
5 4 6 3 0 a



See belts 1" Pitch (25,4 mm):
3 0 3 0 0 a



See also the sprockets and idler wheels:

3 0 3 9 5 a
3 0 3 9 5 c



Information about this product is only available on our Smart Guide® website.



Chains & sprockets	Wear strips	Side guide brackets & accessories	Levelers	Engineering manual
Modular belts & sprockets	Chain & belt return systems	Frame & structure supports	Bearing supports	
Curves & tracks	Side guide solutions	Miscellaneous products	Equipment	

30395c

DRIVE SPROCKETS

www.SystemPlastSmartGuide.com

FOR BELT 2250

Notes:

- Sprockets with single keyway can be used for belt widths up to 680 mm and temperature differences of maximum 30°C.
- For wider belts or bigger temperature differences, sprockets with square bores or round bore with double keyway have to be used.

New design

30995a

Features:

- New design with snap-assembly system included.
- Very high strength.
- Split versions: quick and easy replacement.
- Foolproof design.
- Excellent wear and chemical resistance.
- Recyclable.

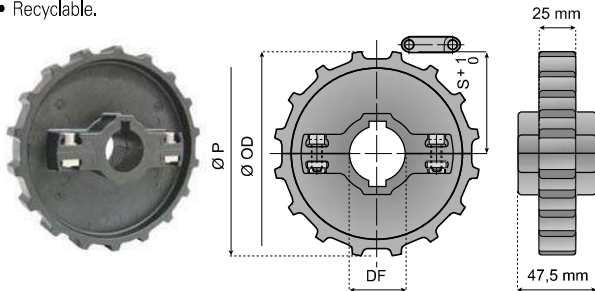

Z	Ø OD mm	Ø P mm	S mm
12	98	98,14	44,0
14	113	114,18	52,0
16	129	130,2	60,0
18	145	146,27	68,5
20	162	162,37	76,5

NOT SUITABLE FOR 2253 SERIES BELTS !



MOLDED DRIVE SPROCKETS - SPLIT DOUBLE KEYWAY - FLOATING

Z	Ø 35	Ø 40
	ITEM DESCRIPTION	
14	2250-14R35M-DPS-K2	2250-14R40M-DPS-K2
16	2250-16R35M-DPS-K2	2250-16R40M-DPS-K2
18	2250-18R35M-DPS-K2	2250-18R40M-DPS-K2
20	2250-20R35M-DPS-K2	2250-20R40M-DPS-K2

Material: reinforced polyamide (black), screws in stainless steel, nuts in nickel plated brass.

Z	Ø OD mm	Ø P mm	S mm
12	96,9	97,75	44,0
14	113,1	113,7	52,1
16	129,4	129,68	60,2
18	145,4	145,7	68,4
20	161,6	161,73	76,5

NOT SUITABLE FOR 2253 SERIES BELTS !

New design

30990a

Features:

- Very high strength.
- Split versions: quick and easy replacement.
- Foolproof design.
- Completely closed structure, easy to clean and to disinfect.
- Excellent wear and chemical resistance.
- Recyclable.

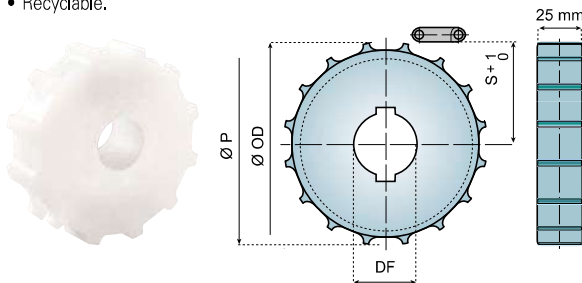

MACHINED DRIVE SPROCKETS - ONE PIECE DOUBLE KEYWAY - FLOATING

Z	Ø 30	Ø 40
	ITEM DESCRIPTION	
12	2250-12R30M-DPM-K2	2250-12R40M-DPM-K2
14	2250-14R30M-DPM-K2	2250-14R40M-DPM-K2
16	2250-16R30M-DPM-K2	2250-16R40M-DPM-K2
18	2250-18R30M-DPM-K2	2250-18R40M-DPM-K2
20	2250-20R30M-DPM-K2	2250-20R40M-DPM-K2

Material: polyamide (natural white).

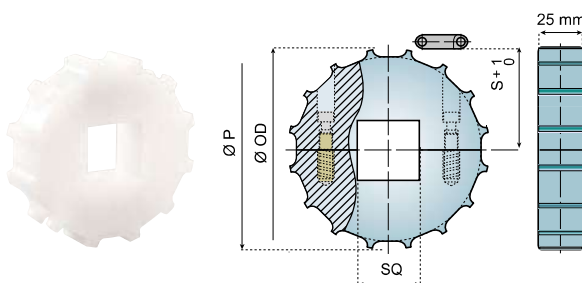

MACHINED DRIVE SPROCKETS SQUARE BORE - SPLIT FLOATING

Z	∇ 30X30	∇ 40X40	∇ 60X60
	ITEM DESCRIPTION		
12	2250-12S30M-DMS	2250-12S40M-DMS	-
14	2250-14S30M-DMS	2250-14S40M-DMS	-
16	2250-16S30M-DMS	2250-16S40M-DMS	-
18	2250-18S30M-DMS	2250-18S40M-DMS	2250-18S60M-DMS
20	2250-20S30M-DMS	2250-20S40M-DMS	2250-20S60M-DMS

Material: polyamide (natural white), screws in stainless steel, bushings in brass.



Information about this product is only available on our Smart Guide® website.



See also the sprockets and idler wheels:

30395a
30395b



See belts 1" Pitch (25,4 mm):

30300a

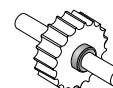

Set collars, go to:

54630a

Chains & sprockets	Wear strips	Side guide brackets & accessories	Levelers	Engineering manual
Modular belts & sprockets	Chain & belt return systems	Frame & structure supports	Bearing supports	
Curves & tracks	Side guide solutions	Miscellaneous products	Equipment	

3 0 3 9 8 a

25,4 mm (1") MODULAR BELTS 2253RTC - THICKNESS: 8,7 mm (0.34 in)

www.SystemPlastSmartGuide.com

ROLLER TOP VERSION



New

continue ►

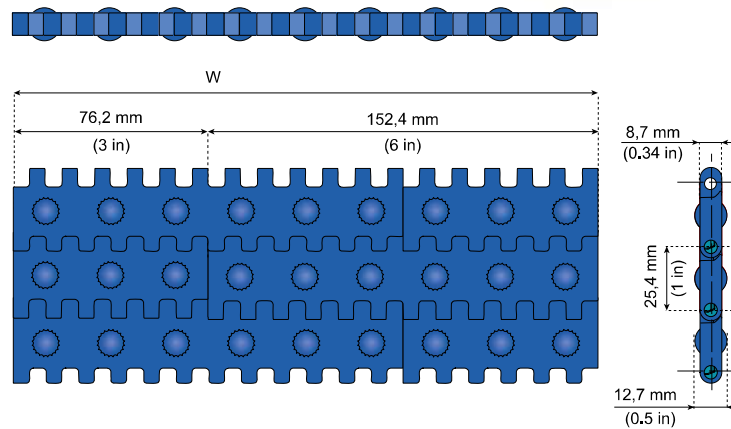
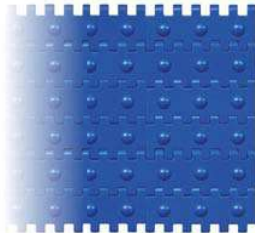

Backflex radius: 40 mm (1.58 in)
Max load capacity: 10500 N/m (714 lbs/ft.)
Max load per ball: 10 N (2.24 lbs)
Weight: 10,5 kg/m² (2.14 lbs/ft²)
Ball material: Polyamide
Standard length:
width ≤ 30 in: 1,524 m (5 ft.)
width > 30 in ≤ 60 in: 1,016 m (3,35 ft.)
width > 60 in: on request
Standard pin material: PBT (white)



Information about this product is only available on our Smart Guide® website.

Standard material

LFB (BLUE)

Low friction acetal resin

materials details:

7 3 5 6 3 a



3 0 3 9 5 a

Other versions for 25,4 mm (1") belts:

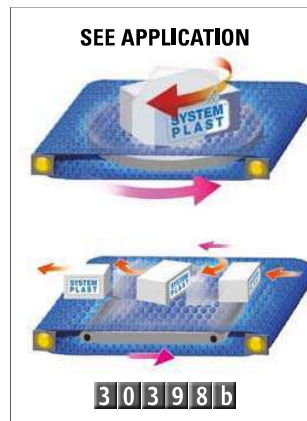
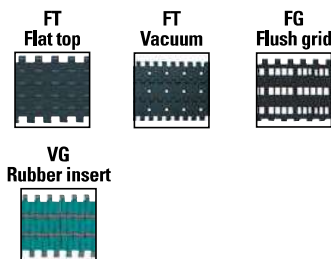

WIDTH W		ITEM DESCRIPTION
mm	in	
76	3.00	LFB2253RTC-K300
152	6.00	LFB2253RTC-K600
229	9.00	LFB2253RTC-K900
305	12.00	LFB2253RTC-K1200
381	15.00	LFB2253RTC-K1500
457	18.00	LFB2253RTC-K1800
533	21.00	LFB2253RTC-K2100
610	24.00	LFB2253RTC-K2400
686	27.00	LFB2253RTC-K2700
762	30.00	LFB2253RTC-K3000
838	33.00	LFB2253RTC-K3300
914	36.00	LFB2253RTC-K3600
991	39.00	LFB2253RTC-K3900
1067	42.00	LFB2253RTC-K4200
1143	45.00	LFB2253RTC-K4500
1219	48.00	LFB2253RTC-K4800
1295	51.00	LFB2253RTC-K5100
1372	54.00	LFB2253RTC-K5400
1448	57.00	LFB2253RTC-K5700
1524	60.00	LFB2253RTC-K6000
1600	63.00	LFB2253RTC-K6300
1676	66.00	LFB2253RTC-K6600
1753	69.00	LFB2253RTC-K6900
1829	72.00	LFB2253RTC-K7200
1905	75.00	LFB2253RTC-K7500
1981	78.00	LFB2253RTC-K7800
2057	81.00	LFB2253RTC-K8100
2134	84.00	LFB2253RTC-K8400
2210	87.00	LFB2253RTC-K8700
2286	90.00	LFB2253RTC-K9000
2362	93.00	LFB2253RTC-K9300
2438	96.00	LFB2253RTC-K9600
2515	99.00	LFB2253RTC-K9900
2590	102.00	LFB2253RTC-K10200
2666	105.00	LFB2253RTC-K10500
2743	108.00	LFB2253RTC-K10800
2819	111.00	LFB2253RTC-K11100

Other widths available on request.

continue ►

Chains & sprockets	Wear strips	Side guide brackets & accessories	Levelers	Engineering manual
Modular belts & sprockets	Chain & belt return systems	Frame & structure supports	Bearing supports	
Curves & tracks	Side guide solutions	Miscellaneous products	Equipment	



◀ back

Double speed

When the belt is moving and the rollers are in contact with a fixed support area, the rollers will start rotating. This will result in movement of the product with a speed that is twice the speed of the belt. This function is very useful when products must be separated from each other.

This function enables the belt to run at lower speed, and that improves belt life and reduces energy consumption.

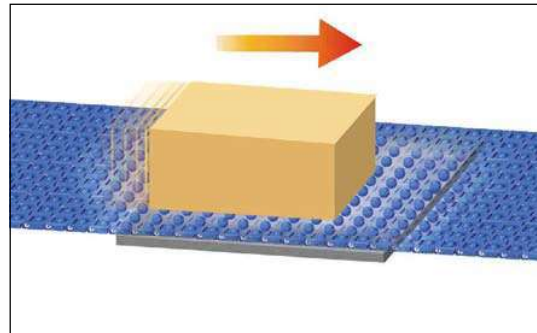

Rotation with product moving

When two parallel running belts are positioned underneath the roller top belts, and running in different directions, containers in the middle of the belt will rotate. This condition is ideal for applications where product orientation is important, for example, the infeed to a palletizer. In this case, containers can be moving forward while rotating.

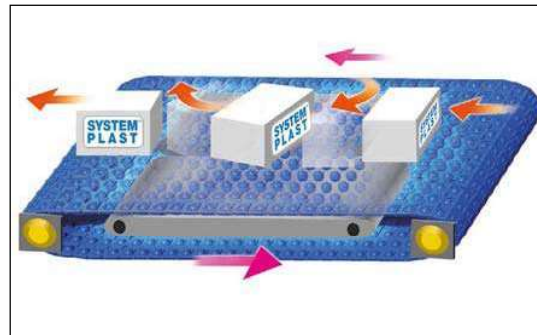

Rotation with product stopped

When using a rotating disc underneath the roller top belt, you can have optimum control of the rotation of the product.

The roller top belt must be stopped during rotation.

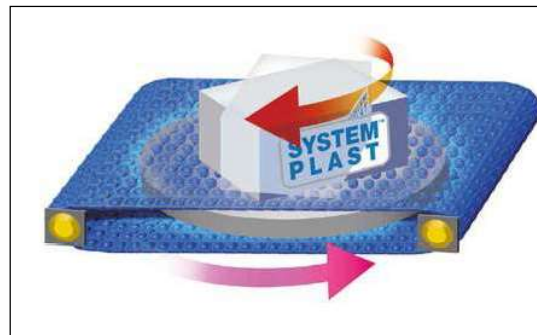

Lateral movement

With a secondary activated belt positioned 90 degrees to the travel direction of the roller top belt, the system can transfer your package without external guides. This scenario is ideal for reject conveyors or any application requiring rapid 90 degree transfer of the conveyed item.

Product positioning can also be achieved by this configuration.

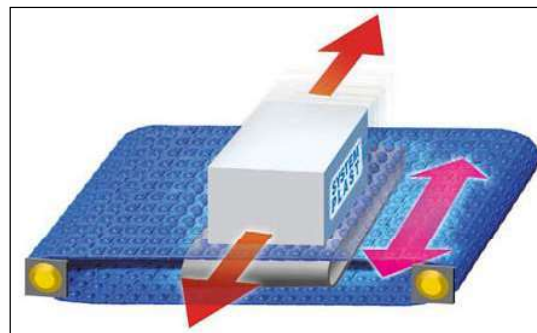

◀ back

Chains & sprockets	Wear strips	Side guide brackets & accessories	Levelers	Engineering manual
Modular belts & sprockets	Chain & belt return systems	Frame & structure supports	Bearing supports	
Curves & tracks	Side guide solutions	Miscellaneous products	Equipment	



30398n

25,4 mm (1") 2253 MODULAR BELTS - THICKNESS: 8,7 mm (0.34 in)

www.SystemPlastSmartGuide.com

FLAT TOP - VACUUM VERSION

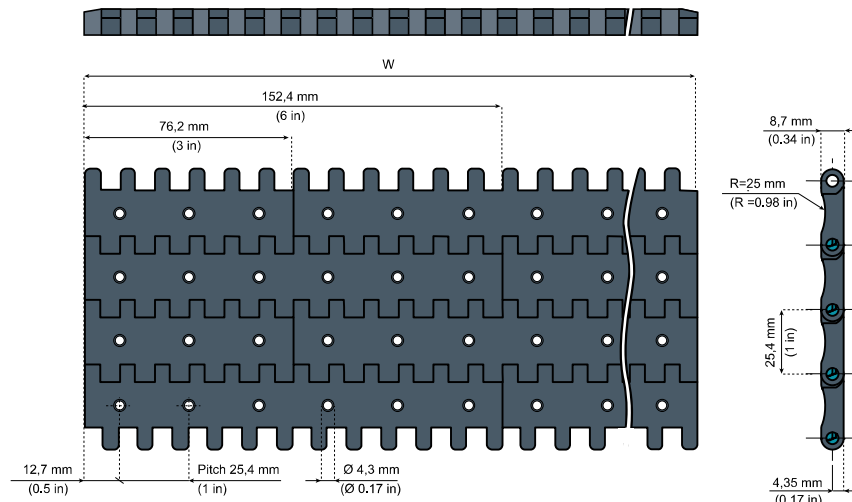
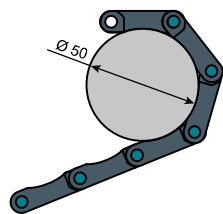

NG® *evo* conveyor components made from engineered plastic resin

Longer wearlife than acetal
 Lower friction than acetal
 Good chemical resistance
 High abrasion resistance
 It meets the requirement for materials as stated by EC1935/2004 and FDA CFR21 norms for direct food contact
 Less dust than with acetal chains
 More.....

Backflex radius: 40 mm (1.58 in)

Max load capacity: 25000 N/m (1700 lbs/ft.)

Weight: 7,3 Kg/m² (1.49 lbs/ft.²)

Standard pin material: PBT (white)

Standard length:

width ≤ 15 in: 3,048 m (10 ft.)

width > 15 in ≤ 66 in: 1,524 m (5 ft.)

width > 66 in: on request

Open surface: 2.24%

Bevelled edges:

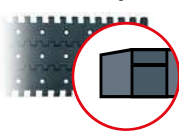

30395a

Other versions for 25,4 mm (1") belts:

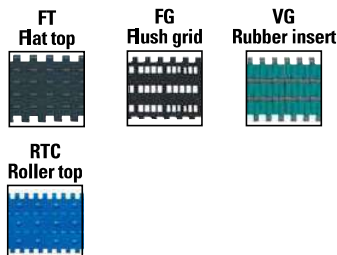

Information about this product is only available on our Smart Guide® website.

Standard materials

NGE (GREY BLUE)

New Generation®

materials details:

73563a

WIDTH W		ITEM DESCRIPTION
mm	in	
305	12.00	NGE2253FT-K1200VAC43
381	15.00	NGE2253FT-K1500VAC43
457	18.00	NGE2253FT-K1800VAC43
533	21.00	NGE2253FT-K2100VAC43
610	24.00	NGE2253FT-K2400VAC43
686	27.00	NGE2253FT-K2700VAC43
762	30.00	NGE2253FT-K3000VAC43
838	33.00	NGE2253FT-K3300VAC43
914	36.00	NGE2253FT-K3600VAC43
991	39.00	NGE2253FT-K3900VAC43
1067	42.00	NGE2253FT-K4200VAC43
1143	45.00	NGE2253FT-K4500VAC43
1219	48.00	NGE2253FT-K4800VAC43
1295	51.00	NGE2253FT-K5100VAC43
1372	54.00	NGE2253FT-K5400VAC43

Other widths available on request.

Chains & sprockets	Wear strips	Side guide brackets & accessories	Levelers	Engineering manual
Modular belts & sprockets	Chain & belt return systems	Frame & structure supports	Bearing supports	
Curves & tracks	Side guide solutions	Miscellaneous products	Equipment	

3 0 3 9 8 z

APPLICATION EXAMPLES

www.SystemPlastSmartGuide.com



ROLLER TOP BELTS IN SORTING/POSITIONING SYSTEM.

Go to:

3 0 3 9 8 a



VACUUM BELT TRANSPORTING CANS.

Go to:

3 0 3 9 8 n



CONVEYOR FOR TRAYS WITH CANS.

For LBP belts, go to:

3 0 5 0 0 a

Rollers side guides, go to:

5 2 5 1 0 a

Chains & sprockets	Wear strips	Side guide brackets & accessories	Levelers	Engineering manual
Modular belts & sprockets	Chain & belt return systems	Frame & structure supports	Bearing supports	
Curves & tracks	Side guide solutions	Miscellaneous products	Equipment	

3 0 4 1 0 a

INDEX MODULAR BELTS

www.SystemPlastSmartGuide.com

25,4 mm (1") PITCH - THICKNESS: 12,7 mm (½")

FLAT TOP VERSION

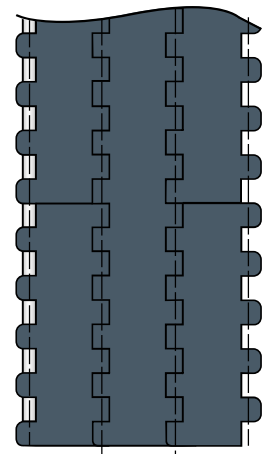
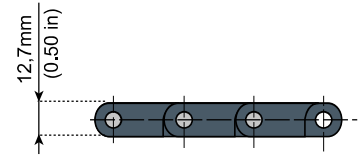
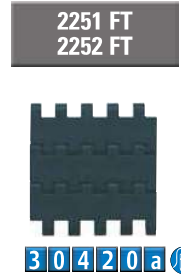
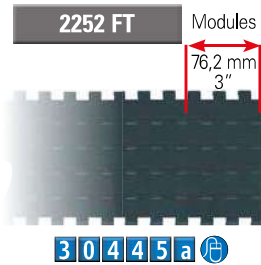
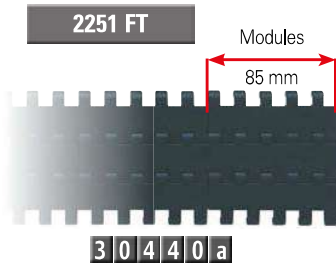

FLAT TOP VERSION WITH TRANSFER WING - 2251 FT

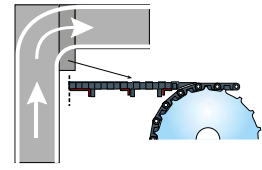
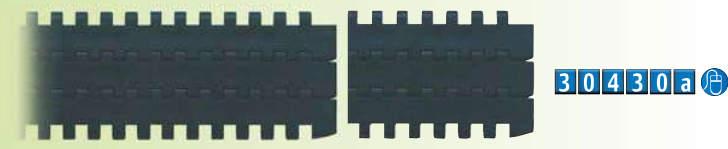

PERFORATED TOP VERSION - 2252 PT

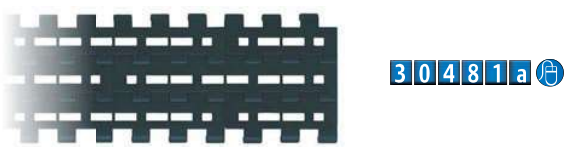

VERSION WITH RUBBER INSERTS - 2251 VG

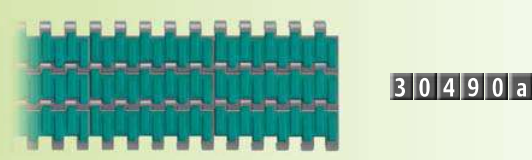

VERSION WITH ACCUMULATION ROLLERS - 2251 LBP

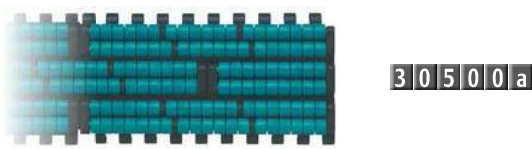

SIDEFLEXING CHAINBELT:

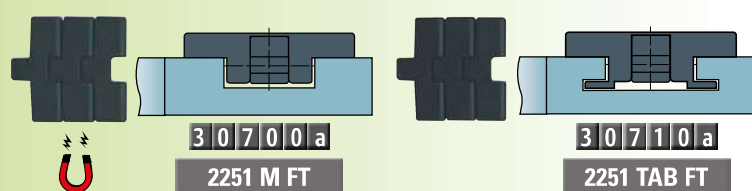

Information about this product is only available on our Smart Guide® website.



Chains & sprockets	Wear strips	Side guide brackets & accessories	Levelers	Engineering manual
Modular belts & sprockets	Chain & belt return systems	Frame & structure supports	Bearing supports	
Curves & tracks	Side guide solutions	Miscellaneous products	Equipment	



3 0 4 2 0 a

25,4 mm (1") MODULAR BELTS - THICKNESS: 12,7 mm (1/2")

www.SystemPlastSmartGuide.com

FLAT TOP VERSION



New
NG evo

NG® evo conveyor components made from engineered plastic resin

- Longer wearlife than acetal
- Lower friction than acetal
- Good chemical resistance
- High abrasion resistance
- It meets the requirement for materials as stated by EC1935/2004 and FDA CFR21 norms for direct food contact
- Less dust than with acetal chains
- More.....

SINGLE TRACK

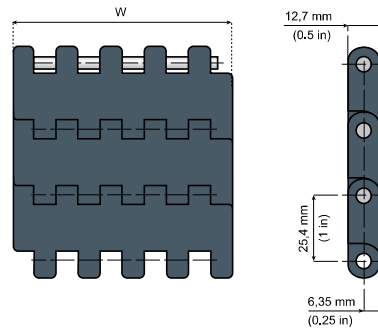

Pin material: PBT (white)

ITEM DESCRIPTION	MATERIAL	WIDTH W		PITCH		BACKFLEX RADIUS		MAX LOAD CAPACITY		WEIGHT	
		mm	in	mm	in	mm	in	N	lbs	Kg/m	lbs/ft
NGE2252FT-K300	NGE Grey Blue	76,2	3	25,4	1	25	1	2600	590	1	0,67
NGE2252FT-K325		82,6	3.25					2800	620	1,2	0,81
NGE2251FT-K330		83,8	3.3					2800	620	1,2	0,81
NGE2252FT-K450		114,3	4.5					3870	860	1,6	1,07
NGE2252FT-K600		152,4	6					5220	1170	2,1	1,4
NGE2252FT-K750		190,5	7.5					6480	1460	2,7	1,81

Standard length: 120 pitches (3,048 m - 10 ft.)

SINGLE TRACK WITH POSITIONER

New
NG evo

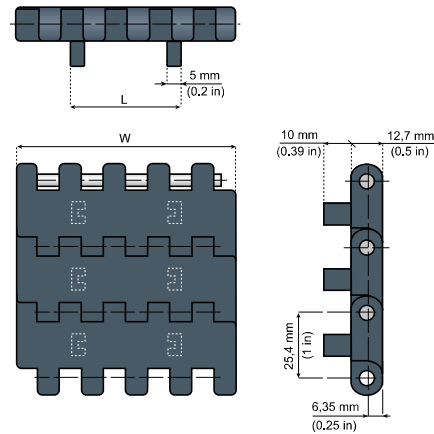

ITEM DESCRIPTION	MATERIAL	L		WIDTH W		PITCH		BACKFLEX RADIUS		MAX LOAD CAPACITY		WEIGHT	
		mm	in	mm	in	mm	in	mm	in	N	lbs	Kg/m	lbs/ft.
NGE2252FT-PT-K300	NGE Grey Blue	43,1	1.7	76,2	3	25,4	1	25	1	2600	590	1	0,67
NGE2252FT-PT-K325		43,1	1.7	82,6	3.25					2800	620	1,2	0,81
NGE2251FT-PT-K330		42,1	1.66	83,8	3.3					2800	620	1,2	0,81
NGE2252FT-PT-K450		43,1	1.7	114,3	4.5					3870	860	1,6	1,07
NGE2252FT-PT-K600		43,1	1.7	152,4	6					5220	1170	2,1	1,4
NGE2252FT-PT-K750		43,1	1.7	190,5	7.5					6480	1460	2,7	1,81

Standard length: 120 pitches (3,048 m - 10 ft.)

3 0 5 5 0 a



Notes: Schematic presentation of all flat top 25,4 mm (1") pitch belts. Thickness: 12,7 mm (0,50 in)

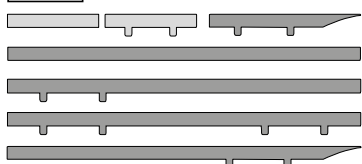

Other versions for 25,4 mm (1") belts:

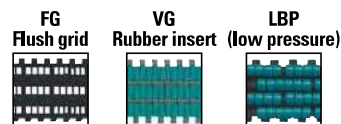

Standard material

NGE (GREY BLUE)

New Generation®

materials details:

7 3 5 6 3 a



Information about this product is only available on our Smart Guide® website.



Chains & sprockets	Wear strips	Side guide brackets & accessories	Levelers	Engineering manual
Modular belts & sprockets	Chain & belt return systems	Frame & structure supports	Bearing supports	
Curves & tracks	Side guide solutions	Miscellaneous products	Equipment	

SYSTEM PLAST®



Information about this product is only available on our Smart Guide® website.

Standard material

NGE (GREY BLUE)

New Generation®

materials details:

7 3 5 6 3 a

3 0 4 3 0 a

25,4 mm (1") 2251 WITH TRANSFER WING - THICKNESS: 12,7 mm (1/2")

www.SystemPlastSmartGuide.com

SINGLE TRACK

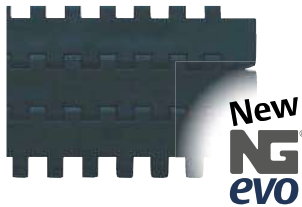

NG® evo conveyor components made from engineered plastic resin
 Longer wearlife than acetal
 Lower friction than acetal
 Good chemical resistance
 High abrasion resistance
 It meets the requirement for materials as stated by EC1935/2004 and FDA CFR21 norms for direct food contact
 Less dust than with acetal chains
 More.....

Pin material: PBT (white)
Backflex radius: 30 mm (1,18 in)

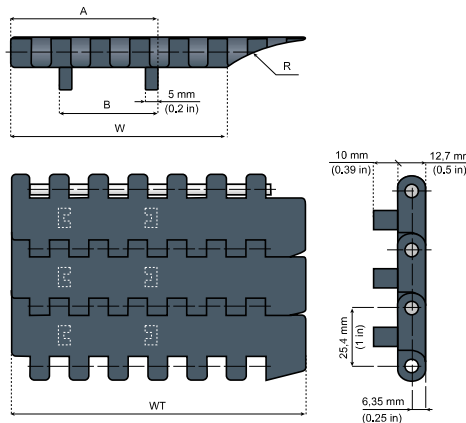

ITEM DESCRIPTION	MATERIAL	A		B		WIDTH W		WIDTH WT		R		MAX LOAD CAPACITY		WEIGHT	
		mm	in	mm	in	mm	in	mm	in	mm	in	N	lbs	Kg/m	lbs/ft.
NGE2251FT-PT-K330T	NGE Grey Blue	63	2,48	42,1	1,66	93	3,66	127	5	80	3,15	2900	650	1,7	1,14
NGE2251FT-PT-K430TL		78,6	3,095	43,2	1,7	109,5	4,31	160	6,3	150	5,91	3800	850	2,2	1,5
NGE2251FT-PT-K730TL		116,7	4,6	43,2	1,7	185	7,3	236,2	9,3	150	5,91	6200	1400	3,2	2,2

Standard length: 120 pitches (3,048 m - 10 ft.)

WIDER VERSIONS

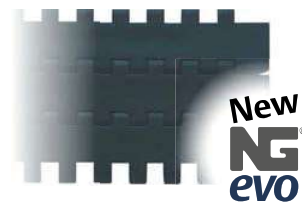

Backflex radius: 30 mm (1,18 in)
Max load capacity: 34200 N/m (2350 lbs/ft.)
Weight: 12,5 Kg/m² (2,55 lbs/ft².)
Pin material: PBT (white)
Standard length:
 width ≤ 340 mm (13,39 in): 3,048 m (10 ft.)
 width > 340 mm (13,39 in) ≤ 935 mm (36,81 in): 1,524 m (5 ft.)

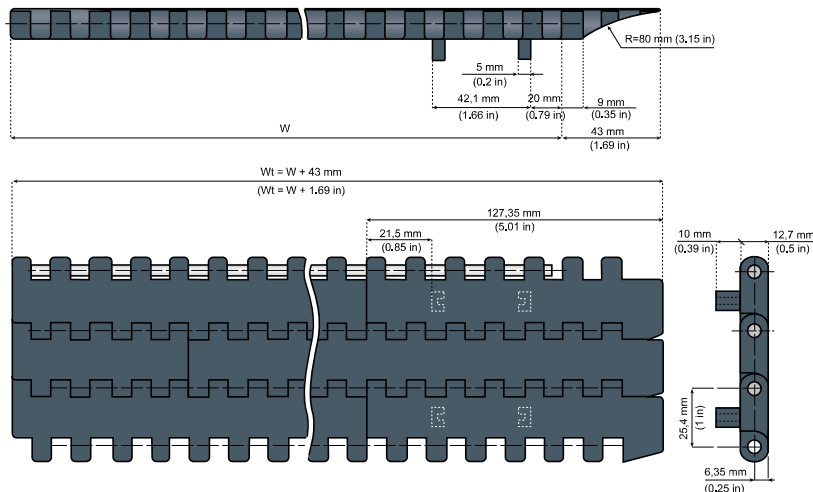

3 0 5 5 0 a

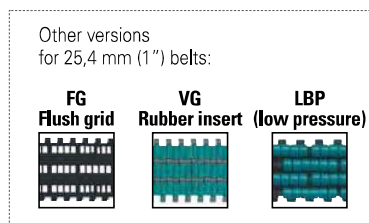
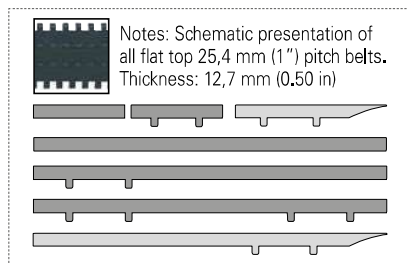

WIDTH W		ITEM DESCRIPTION
mm	in	
85	3,35	NGE2251FT-PT-M0085T
170	6,69	NGE2251FT-PT-M0170T
255	10,04	NGE2251FT-PT-M0255T
340	13,39	NGE2251FT-PT-M0340T
425	16,73	NGE2251FT-PT-M0425T
510	20,08	NGE2251FT-PT-M0510T

Version with Positioning Tabs located on opposite side of belt from transfer wing is available. Replace "PT" with "PTX" if this orientation is desired.



Chains & sprockets	Wear strips	Side guide brackets & accessories	Levelers	Engineering manual
Modular belts & sprockets	Chain & belt return systems	Frame & structure supports	Bearing supports	
Curves & tracks	Side guide solutions	Miscellaneous products	Equipment	

30440a

25,4 mm (1in) MODULAR BELTS 2251 - THICKNESS: 12,7 mm (1/2")

www.SystemPlastSmartGuide.com

FLAT TOP VERSION

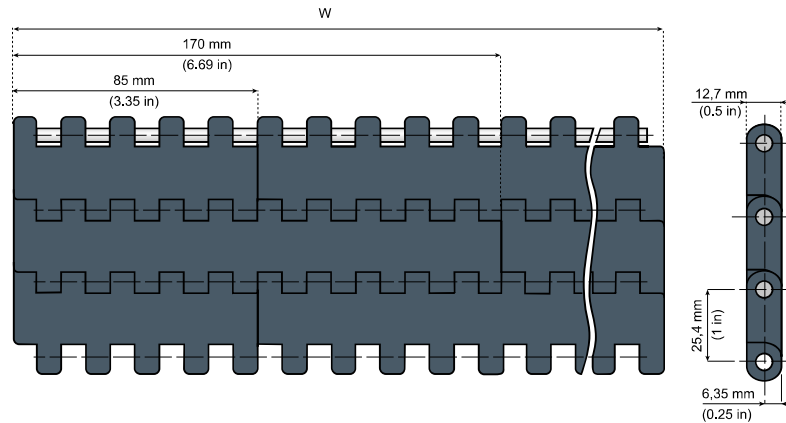
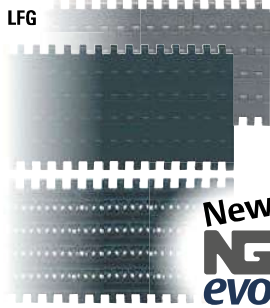

NG® evo conveyor components made from engineered plastic resin

- Longer wearlife than acetal
- Lower friction than acetal
- Good chemical resistance
- High abrasion resistance
- It meets the requirement for materials as stated by EC1935/2004 and FDA CFR21 norms for direct food contact
- Less dust than with acetal chains
- More.....

Backflex radius: 25 mm (0,98 in)

Max load capacity (LFG): 38000 N/m (2.600 lbs/ft.)

Weight: 12,5 Kg/m² (2,55 lbs/ft.²)

Pin material: PBT (white)

Standard length:

- width ≤ 340 mm (13,39 in): 3,048 m (10 ft.)
- width > 340 mm (13,39 in) ≤ 935 mm (36,81 in): 1,524 m (5 ft.)
- width > 935 mm (36,81 in): on request

Standard materials

NGE (GREY BLUE)
New Generation®
LFG (GREY)
Low friction acetal resin

materials details:



Information about this product is only available on our Smart Guide® website.

Other versions for 25,4 mm (1") belts:

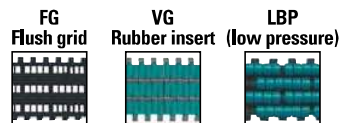

Notes: Schematic presentation of all flat top 25,4 mm (1") pitch belts. Thickness: 12,7 mm (0,50 in)

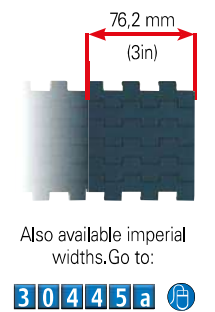
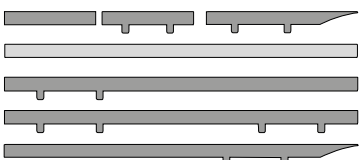

Also available imperial widths. Go to:



WIDTH W		ITEM DESCRIPTION	
mm	in	NGE (GREY BLUE)	LFG (GREY)
85	3.35	NGE2251FT-M0085	LFG2251FT-M0085
170	6.69	NGE2251FT-M0170	LFG2251FT-M0170
255	10.04	NGE2251FT-M0255	LFG2251FT-M0255
340	13.39	NGE2251FT-M0340	LFG2251FT-M0340
425	16.73	NGE2251FT-M0425	LFG2251FT-M0425
510	20.08	NGE2251FT-M0510	LFG2251FT-M0510
595	23.43	NGE2251FT-M0595	LFG2251FT-M0595
680	26.77	NGE2251FT-M0680	LFG2251FT-M0680
765	30.12	NGE2251FT-M0765	LFG2251FT-M0765
850	33.46	NGE2251FT-M0850	LFG2251FT-M0850
935	36.81	NGE2251FT-M0935	LFG2251FT-M0935
1020	40.16	NGE2251FT-M1020	LFG2251FT-M1020
1105	43.50	NGE2251FT-M1105	LFG2251FT-M1105
1190	46.85	NGE2251FT-M1190	LFG2251FT-M1190
1275	50.20	NGE2251FT-M1275	LFG2251FT-M1275
1360	53.54	NGE2251FT-M1360	LFG2251FT-M1360
1445	56.89	NGE2251FT-M1445	LFG2251FT-M1445
1530	60.24	NGE2251FT-M1530	LFG2251FT-M1530
1615	63.58	NGE2251FT-M1615	LFG2251FT-M1615
1700	66.93	NGE2251FT-M1700	LFG2251FT-M1700
1785	70.28	NGE2251FT-M1785	LFG2251FT-M1785
1870	73.62	NGE2251FT-M1870	LFG2251FT-M1870
1955	76.97	NGE2251FT-M1955	LFG2251FT-M1955
2040	80.31	NGE2251FT-M2040	LFG2251FT-M2040
2125	83.66	NGE2251FT-M2125	LFG2251FT-M2125
2210	87.01	NGE2251FT-M2210	LFG2251FT-M2210
2295	90.35	NGE2251FT-M2295	LFG2251FT-M2295

Other widths available on request.

Chains & sprockets	Wear strips	Side guide brackets & accessories	Levelers	Engineering manual
Modular belts & sprockets	Chain & belt return systems	Frame & structure supports	Bearing supports	
Curves & tracks	Side guide solutions	Miscellaneous products	Equipment	

3 0 4 4 5 a

25,4 mm (1") MODULAR BELTS 2252 - THICKNESS: 12,7 mm (1/2")

www.SystemPlastSmartGuide.com

FLAT TOP VERSION - 76,2 mm (3") MODULES

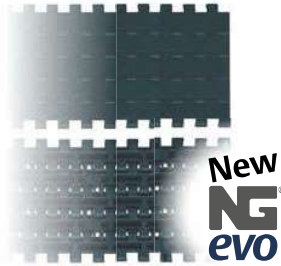

NG® evo conveyor components made from engineered plastic resin

- Longer wearlife than acetal
- Lower friction than acetal
- Good chemical resistance
- High abrasion resistance
- It meets the requirement for materials as stated by EC1935/2004 and FDA CFR21 norms for direct food contact
- Less dust than with acetal chains
- More.....

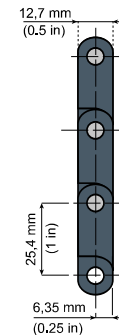
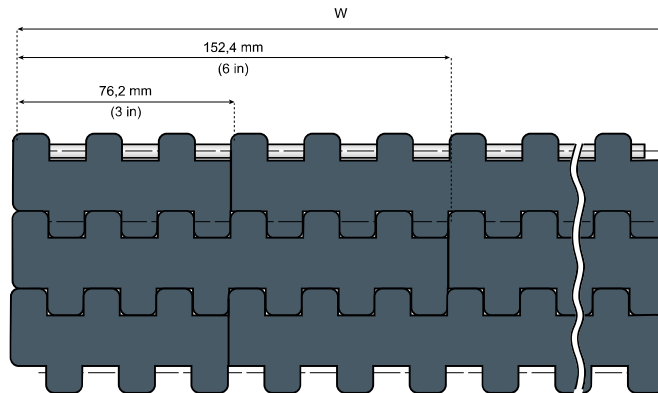

- Backflex radius:** 1 in (25,4 mm)
- Max load capacity:** 34200 N/m (2340 lbs/ft.)
- Weight:** 12,9 Kg/m² (2,63 lbs/ft.²)
- Pin material:** PBT (white)
- Standard length:**
 - width ≤ 15 in: 3,048 m (ft.)
 - width > 15 in ≤ 36 in: 1,524 m (5 ft.)
 - width > 36 in: on request

Standard material

NGE (GREY BLUE)

New Generation®



Other versions for 25,4 mm (1") belts:

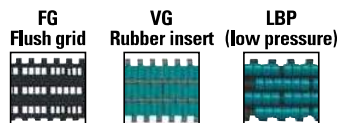

Notes: Schematic presentation of all flat top 25,4 mm (1") pitch belts. Thickness: 12,7 mm (0.50 in)

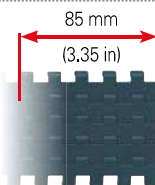
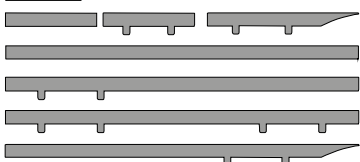

Also available in metric widths. Go to:

3 0 4 4 0 a



Information about this product is only available on our Smart Guide® website.

WIDTH W		ITEM DESCRIPTION
mm	in	
76	3.00	NGE2252FT-K300
152	6.00	NGE2252FT-K600
229	9.00	NGE2252FT-K900
305	12.00	NGE2252FT-K1200
381	15.00	NGE2252FT-K1500
457	18.00	NGE2252FT-K1800
533	21.00	NGE2252FT-K2100
610	24.00	NGE2252FT-K2400
686	27.00	NGE2252FT-K2700
762	30.00	NGE2252FT-K3000
838	33.00	NGE2252FT-K3300
914	36.00	NGE2252FT-K3600
991	39.00	NGE2252FT-K3900
1067	42.00	NGE2252FT-K4200
1143	45.00	NGE2252FT-K4500
1219	48.00	NGE2252FT-K4800
1295	51.00	NGE2252FT-K5100
1372	54.00	NGE2252FT-K5400
1448	57.00	NGE2252FT-K5700
1524	60.00	NGE2252FT-K6000
1600	63.00	NGE2252FT-K6300
1676	66.00	NGE2252FT-K6600
1753	69.00	NGE2252FT-K6900
1829	72.00	NGE2252FT-K7200
1905	75.00	NGE2252FT-K7500
1981	78.00	NGE2252FT-K7800
2057	81.00	NGE2252FT-K8100
2134	84.00	NGE2252FT-K8400
2210	87.00	NGE2252FT-K8700
2286	90.00	NGE2252FT-K9000

Other widths available on request.



Chains & sprockets	Wear strips	Side guide brackets & accessories	Levelers	Engineering manual
Modular belts & sprockets	Chain & belt return systems	Frame & structure supports	Bearing supports	
Curves & tracks	Side guide solutions	Miscellaneous products	Equipment	

3 0 4 5 0 b

www.SystemPlastSmartGuide.com

25,4 mm (1") MODULAR BELTS 2251 - THICKNESS: 12,7 mm (1/2")

FLAT TOP VERSION WITH TWIN POSITIONERS

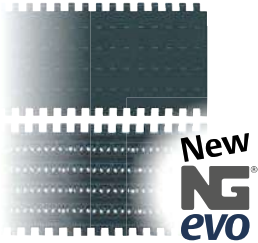

NG® evo conveyor components made from engineered plastic resin

Longer wearlife than acetal
 Lower friction than acetal
 Good chemical resistance
 High abrasion resistance
 It meets the requirement for materials as stated by EC1935/2004 and FDA CFR21 norms for direct food contact
 Less dust than with acetal chains
 More.....

Backflex radius:

25 mm (0.98 in)

Max load capacity:

38000 N/m (2600 lbs/ft.)

Weight: 12,5 Kg/m² (2.55 lbs/ft²)

Pin material: PBT (white)

Standard length:

width ≤ 340 mm (13.39 in): 3,048 m (10 ft.)

width > 340 mm (13.39 in) ≤ 935 mm (36.81 in): 1,524 m (5 ft.)

width > 935 mm (36.81 in): on request

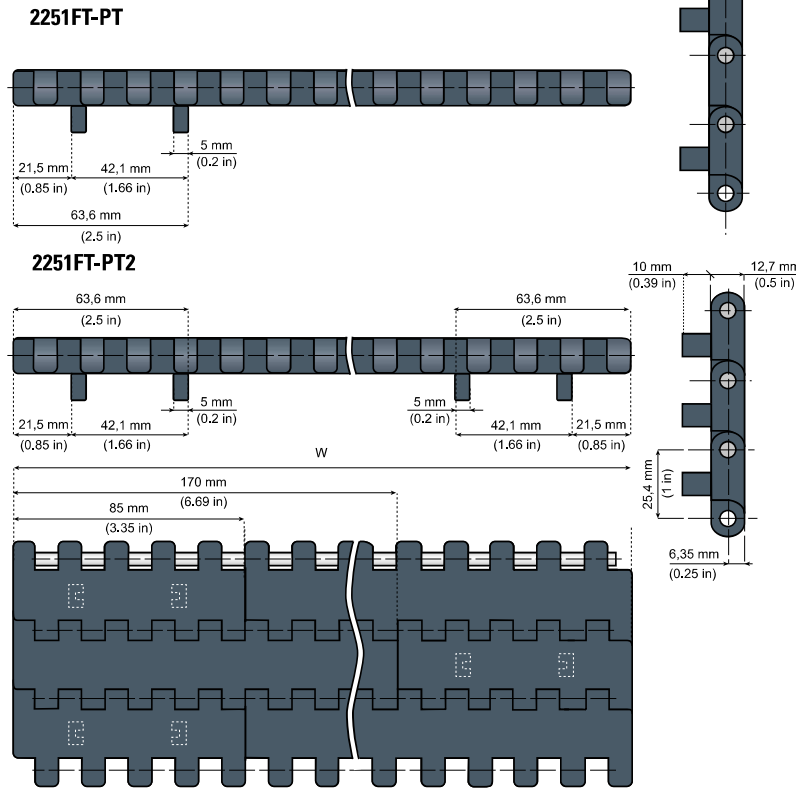

Information about this product is only available on our Smart Guide® website.

Standard materials

NGE (GREY BLUE)

New Generation®

LFG (GREY)

Low friction acetal resin

materials details:



Other versions for 25,4 mm (1") belts:

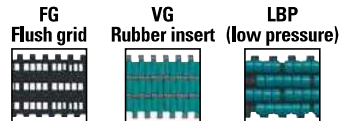

Notes: Schematic presentation of all flat top 25,4 mm (1") pitch belts. Thickness: 12,7 mm (0.50 in)

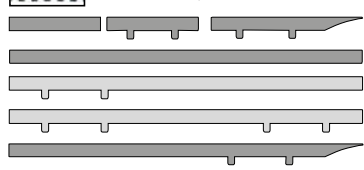

WIDTH W		ITEM DESCRIPTION	ITEM DESCRIPTION
mm	in		
85	3.35	NGE2251FT-PT-M0085	-
170	6.69	NGE2251FT-PT-M0170	NGE2251FT-PT2-M0170
255	10.04	NGE2251FT-PT-M0255	NGE2251FT-PT2-M0255
340	13.39	NGE2251FT-PT-M0340	NGE2251FT-PT2-M0340
425	16.73	NGE2251FT-PT-M0425	NGE2251FT-PT2-M0425
510	20.08	NGE2251FT-PT-M0510	NGE2251FT-PT2-M0510
595	23.43	NGE2251FT-PT-M0595	NGE2251FT-PT2-M0595
680	26.77	NGE2251FT-PT-M0680	NGE2251FT-PT2-M0680
765	30.12	NGE2251FT-PT-M0765	NGE2251FT-PT2-M0765
850	33.46	NGE2251FT-PT-M0850	NGE2251FT-PT2-M0850
935	36.81	NGE2251FT-PT-M0935	NGE2251FT-PT2-M0935
1020	40.16	NGE2251FT-PT-M1020	NGE2251FT-PT2-M1020
1105	43.50	NGE2251FT-PT-M1105	NGE2251FT-PT2-M1105
1190	46.85	NGE2251FT-PT-M1190	NGE2251FT-PT2-M1190
1275	50.20	NGE2251FT-PT-M1275	NGE2251FT-PT2-M1275
1360	53.54	NGE2251FT-PT-M1360	NGE2251FT-PT2-M1360
1445	56.89	NGE2251FT-PT-M1445	NGE2251FT-PT2-M1445
1530	60.24	NGE2251FT-PT-M1530	NGE2251FT-PT2-M1530
1615	63.58	NGE2251FT-PT-M1615	NGE2251FT-PT2-M1615
1700	66.93	NGE2251FT-PT-M1700	NGE2251FT-PT2-M1700
1785	70.28	NGE2251FT-PT-M1785	NGE2251FT-PT2-M1785
1870	73.62	NGE2251FT-PT-M1870	NGE2251FT-PT2-M1870

Other widths available on request.



Chains & sprockets	Wear strips	Side guide brackets & accessories	Levelers	Engineering manual
Modular belts & sprockets	Chain & belt return systems	Frame & structure supports	Bearing supports	
Curves & tracks	Side guide solutions	Miscellaneous products	Equipment	



3 0 4 8 1 a

25,4 mm (1") 2252 MODULAR BELTS - THICKNESS: 12,7 mm (1/2")

www.SystemPlastSmartGuide.com

PERFORATED TOP VERSION

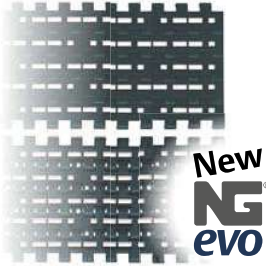

New NG evo

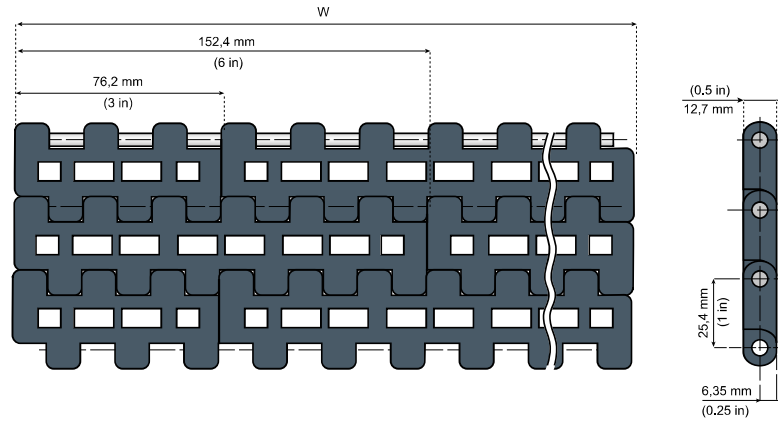

NG® evo conveyor components made from engineered plastic resin

- Longer wearlife than acetal
- Lower friction than acetal
- Good chemical resistance
- High abrasion resistance
- It meets the requirement for materials as stated by EC1935/2004 and FDA CFR21 norms for direct food contact
- Less dust than with acetal chains
- More.....

Backflex radius: 25,4 mm (1")

Max load capacity: 34200 N/m (2340 lbs/ft.)

Weight: 14,0 Kg/m² (2,86 lbs/ft².)

Pin material: PBT (white)

Open surface: 14%

Standard length:

width ≤ 15 in: 3,048 m (10 ft.)

width > 15 in, but ≤ 36 in: 1,524 m (5 ft.)

width > 36 in: on request



Information about this product is only available on our Smart Guide® website.

Standard material

NGE (GREY BLUE)

New Generation®

materials details:

7 3 5 6 3 a



3 0 5 5 0 a

Other versions for 25,4 mm (1") belts:

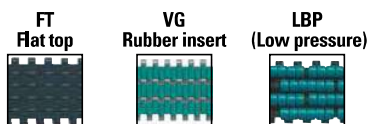

WIDTH W		ITEM DESCRIPTION
mm	in	
76	3.00	NGE2252PT-K300
152	6.00	NGE2252PT-K600
229	9.00	NGE2252PT-K900
305	12.00	NGE2252PT-K1200
381	15.00	NGE2252PT-K1500
457	18.00	NGE2252PT-K1800
533	21.00	NGE2252PT-K2100
610	24.00	NGE2252PT-K2400
686	27.00	NGE2252PT-K2700
762	30.00	NGE2252PT-K3000
838	33.00	NGE2252PT-K3300
914	36.00	NGE2252PT-K3600
991	39.00	NGE2252PT-K3900
1067	42.00	NGE2252PT-K4200
1143	45.00	NGE2252PT-K4500
1219	48.00	NGE2252PT-K4800
1295	51.00	NGE2252PT-K5100
1372	54.00	NGE2252PT-K5400

Other widths available on request.



Chains & sprockets	Wear strips	Side guide brackets & accessories	Levelers	Engineering manual
Modular belts & sprockets	Chain & belt return systems	Frame & structure supports	Bearing supports	
Curves & tracks	Side guide solutions	Miscellaneous products	Equipment	



30490a

25,4 mm (1") MODULAR BELTS - THICKNESS: 12,7 mm (½")

www.SystemPlastSmartGuide.com

RUBBER INSERT EVERY PITCH

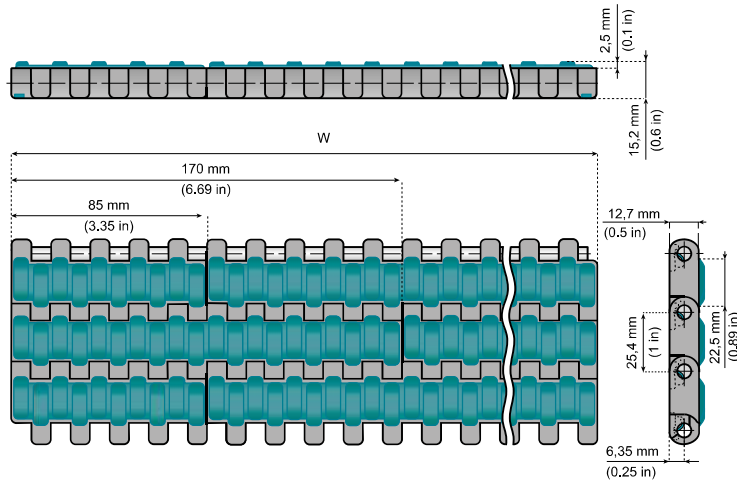

Belt material: low friction acetal resin, grey colour
Rubber material: thermoplastic rubber, waterblue colour, 70 shore A.
Backflex radius: 30 mm (1.18 in)
Max load capacity: 38000 N/m (2600 lbs/ft.)
Pin material: PBT (white)
Standard length:
width ≤ 340 mm (13.39 in): 3,048 m (10 ft.)
width > 340 mm (13.39 in) ≤ 935 mm (36.81 in): 1,524 m (5 ft.)
width > 935 mm (36.81 in): on request

VG 2251
Insert every pitch

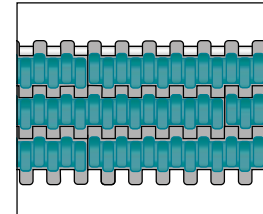

Weight:
13,5 Kg/m² (2.75 lbs/ft²)

30550a

Standard material

LFG (GREY)

Low friction acetal resin

materials details:

73563a

TPR (WATER BLUE)

Thermoplastic rubber

materials details:

73570a



Information about this product is only available on our Smart Guide® website.

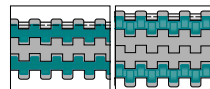

For insert every 2nd or 3th pitch, go to:

30490b

Other versions for 25,4 mm (1") belts:

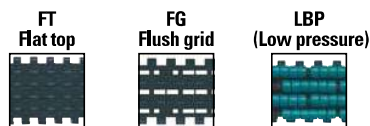

Notes: Schematic presentation of all VG rubber insert 25,4 mm (1") pitch belts. Thickness: 12,7 mm (½")

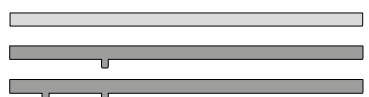

Also available with side indent. Go to:

30495a

WIDTH W		ITEM DESCRIPTION
mm	in	
85	3,35	LFG2251FT-M0085VG
170	6,69	LFG2251FT-M0170VG
255	10,04	LFG2251FT-M0255VG
340	13,39	LFG2251FT-M0340VG
425	16,73	LFG2251FT-M0425VG
510	20,08	LFG2251FT-M0510VG
595	23,43	LFG2251FT-M0595VG
680	26,77	LFG2251FT-M0680VG
765	30,12	LFG2251FT-M0765VG
850	33,46	LFG2251FT-M0850VG
935	36,81	LFG2251FT-M0935VG
1020	40,16	LFG2251FT-M1020VG
1105	43,50	LFG2251FT-M1105VG
1190	46,85	LFG2251FT-M1190VG
1275	50,20	LFG2251FT-M1275VG
1360	53,54	LFG2251FT-M1360VG
1445	56,89	LFG2251FT-M1445VG
1530	60,24	LFG2251FT-M1530VG
1615	63,58	LFG2251FT-M1615VG
1700	66,93	LFG2251FT-M1700VG
1785	70,28	LFG2251FT-M1785VG
1870	73,62	LFG2251FT-M1870VG

Other widths available on request.

Chains & sprockets	Wear strips	Side guide brackets & accessories	Levelers	Engineering manual
Modular belts & sprockets	Chain & belt return systems	Frame & structure supports	Bearing supports	
Curves & tracks	Side guide solutions	Miscellaneous products	Equipment	



3 0 4 9 0 b

25,4 mm (1") MODULAR BELTS - THICKNESS: 12,7 mm (½")

www.SystemPlastSmartGuide.com

RUBBER INSERT EVERY 2ND & 3TH PITCH

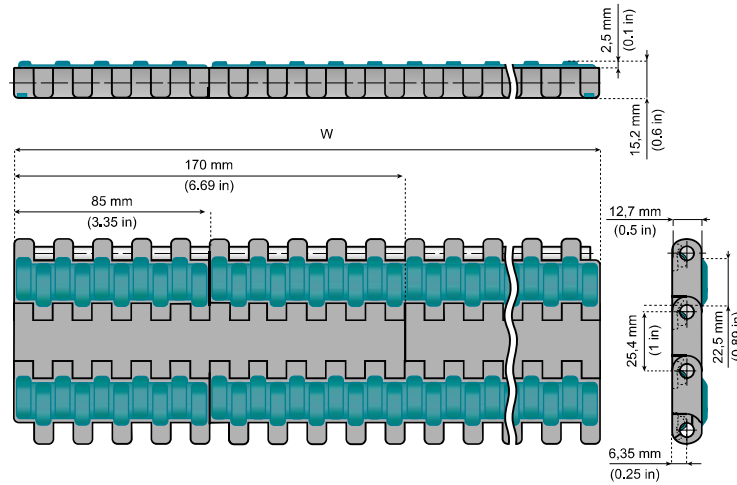
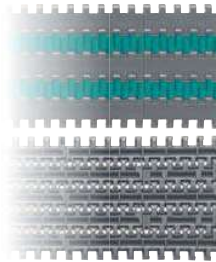

Belt material: low friction acetal resin, grey colour
Rubber material: thermoplastic rubber, waterblue colour, 70 shore A.
Backflex radius: 30 mm (1.18 in)
Max load capacity: 38000 N/m (2600 lbs/ft.)
Pin material: PBT (white)
Standard length:
width ≤ 340 mm (13.39 in): 3,048 m (10 ft.)
width > 340 mm (13.39 in) ≤ 935 mm (36.81 in): 1,524 m (5 ft.)
width > 935 mm (36.81 in): on request

3 0 5 5 0 a

Standard material

LFG (GREY)

Low friction acetal resin

materials details:

7 3 5 6 3 a

TPR (WATER BLUE)

Thermoplastic rubber

materials details:

7 3 5 7 0 a

Other versions for 25,4 mm (1") belts:

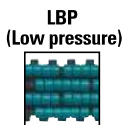

Information about this product is only available on our Smart Guide® website.

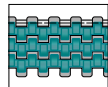

For every insert, go to:

3 0 4 9 0 a



Notes: Schematic presentation of all VG rubber insert 25,4 mm (1") pitch belts. Thickness: 12,7 mm (½")

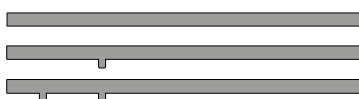

Also available with side indent. Go to:

3 0 4 9 5 a

VG2 2251 Insert every 2nd pitch

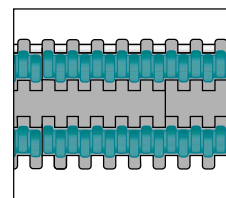

Weight:
13,0 Kg/m² (2.65 lbs/ft²)

VG3 2251 Insert every 3th pitch

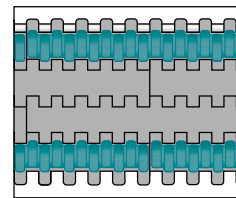

Weight:
12,8 Kg/m² (2.61 lbs/ft²)

WIDTH W		ITEM DESCRIPTION	ITEM DESCRIPTION
mm	in		
85	3.35	LFG2251FT-M0085VG-2	LFG2251FT-M0085VG-3
170	6.69	LFG2251FT-M0170VG-2	LFG2251FT-M0170VG-3
255	10.04	LFG2251FT-M0255VG-2	LFG2251FT-M0255VG-3
340	13.39	LFG2251FT-M0340VG-2	LFG2251FT-M0340VG-3
425	16.73	LFG2251FT-M0425VG-2	LFG2251FT-M0425VG-3
510	20.08	LFG2251FT-M0510VG-2	LFG2251FT-M0510VG-3
595	23.43	LFG2251FT-M0595VG-2	LFG2251FT-M0595VG-3
680	26.77	LFG2251FT-M0680VG-2	LFG2251FT-M0680VG-3
765	30.12	LFG2251FT-M0765VG-2	LFG2251FT-M0765VG-3
850	33.46	LFG2251FT-M0850VG-2	LFG2251FT-M0850VG-3
935	36.81	LFG2251FT-M0935VG-2	LFG2251FT-M0935VG-3
1020	40.16	LFG2251FT-M1020VG-2	LFG2251FT-M1020VG-3
1105	43.50	LFG2251FT-M1105VG-2	LFG2251FT-M1105VG-3
1190	46.85	LFG2251FT-M1190VG-2	LFG2251FT-M1190VG-3
1275	50.20	LFG2251FT-M1275VG-2	LFG2251FT-M1275VG-3
1360	53.54	LFG2251FT-M1360VG-2	LFG2251FT-M1360VG-3
1445	56.89	LFG2251FT-M1445VG-2	LFG2251FT-M1445VG-3
1530	60.24	LFG2251FT-M1530VG-2	LFG2251FT-M1530VG-3
1615	63.58	LFG2251FT-M1615VG-2	LFG2251FT-M1615VG-3
1700	66.93	LFG2251FT-M1700VG-2	LFG2251FT-M1700VG-3
1785	70.28	LFG2251FT-M1785VG-2	LFG2251FT-M1785VG-3
1870	73.62	LFG2251FT-M1870VG-2	LFG2251FT-M1870VG-3

Other widths available on request.

Chains & sprockets	Wear strips	Side guide brackets & accessories	Levelers	Engineering manual
Modular belts & sprockets	Chain & belt return systems	Frame & structure supports	Bearing supports	
Curves & tracks	Side guide solutions	Miscellaneous products	Equipment	

30490c

25,4 mm (1") MODULAR BELTS - THICKNESS: 12,7 mm (½")

www.SystemPlastSmartGuide.com

VERSIONS WITH POSITIONERS / RUBBER INSERTS

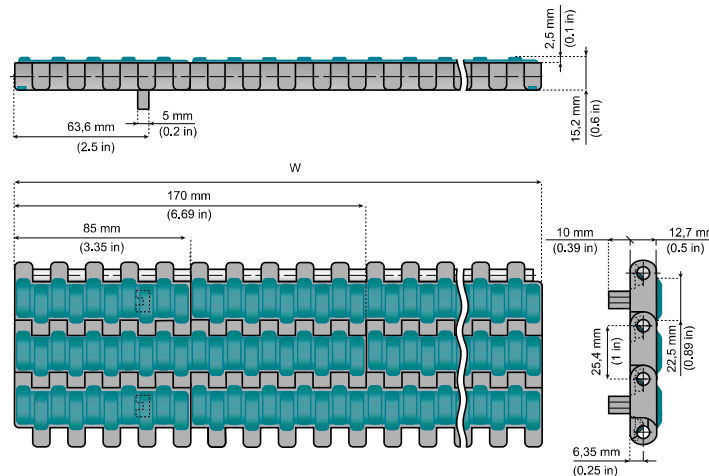

Belt material: low friction acetal resin, grey colour

Rubber material: thermoplastic rubber, waterblue colour, 70 shore A.

Backflex radius: 30 mm (1.18 in)

Max load capacity: 38000 N/m (2600 lbs/ft.)

Pin material: PBT (white)

Standard length:

width ≤ 340 mm (13.39 in): 3,048 m (10 ft.)

width > 340 mm (13.39 in) ≤ 935 mm (36.81 in): 1,524 m (5 ft.)

width > 935 mm (36.81 in): on request

Also available with side indent. Go to:

30495a

Information about this product is only available on our Smart Guide® website.

Standard material

LFG (GREY)

Low friction acetal resin

materials details:

73563a

TPR (WATER BLUE)

Thermoplastic rubber

materials details:

73570a

Other versions for 25,4 mm (1") belts:

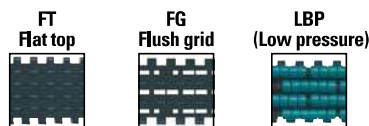

Notes: Schematic presentation of all VG rubber insert 25,4 mm (1") pitch belts. Thickness: 12,7 mm (½")

VG 2251 P1
Insert every pitch

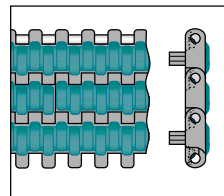

Weight:
13,5 Kg/m² (2.75 lbs/ft²)

VG2 2251 P1
Insert every 2nd pitch

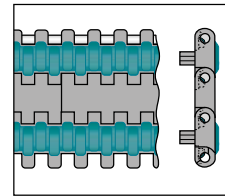

Weight:
13,0 Kg/m² (2.65 lbs/ft²)

VG3 2251 P1
Insert every 3th pitch

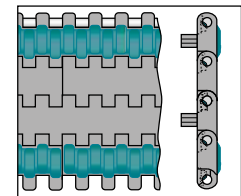

Weight:
12,8 Kg/m² (2.61 lbs/ft²)

WIDTH W		ITEM DESCRIPTION	ITEM DESCRIPTION	ITEM DESCRIPTION
mm	in			
85	3.35	LFG2251FT-P-M0085VG	LFG2251FT-P-M0085VG-2	LFG2251FT-P-M0085VG-3
170	6.69	LFG2251FT-P-M0170VG	LFG2251FT-P-M0170VG-2	LFG2251FT-P-M0170VG-3
255	10.04	LFG2251FT-P-M0255VG	LFG2251FT-P-M0255VG-2	LFG2251FT-P-M0255VG-3
340	13.39	LFG2251FT-P-M0340VG	LFG2251FT-P-M0340VG-2	LFG2251FT-P-M0340VG-3
425	16.73	LFG2251FT-P-M0425VG	LFG2251FT-P-M0425VG-2	LFG2251FT-P-M0425VG-3
510	20.08	LFG2251FT-P-M0510VG	LFG2251FT-P-M0510VG-2	LFG2251FT-P-M0510VG-3
595	23.43	LFG2251FT-P-M0595VG	LFG2251FT-P-M0595VG-2	LFG2251FT-P-M0595VG-3
680	26.77	LFG2251FT-P-M0680VG	LFG2251FT-P-M0680VG-2	LFG2251FT-P-M0680VG-3
765	30.12	LFG2251FT-P-M0765VG	LFG2251FT-P-M0765VG-2	LFG2251FT-P-M0765VG-3
850	33.46	LFG2251FT-P-M0850VG	LFG2251FT-P-M0850VG-2	LFG2251FT-P-M0850VG-3
935	36.81	LFG2251FT-P-M0935VG	LFG2251FT-P-M0935VG-2	LFG2251FT-P-M0935VG-3
1020	40.16	LFG2251FT-P-M1020VG	LFG2251FT-P-M1020VG-2	LFG2251FT-P-M1020VG-3
1105	43.50	LFG2251FT-P-M1105VG	LFG2251FT-P-M1105VG-2	LFG2251FT-P-M1105VG-3
1190	46.85	LFG2251FT-P-M1190VG	LFG2251FT-P-M1190VG-2	LFG2251FT-P-M1190VG-3
1275	50.20	LFG2251FT-P-M1275VG	LFG2251FT-P-M1275VG-2	LFG2251FT-P-M1275VG-3
1360	53.54	LFG2251FT-P-M1360VG	LFG2251FT-P-M1360VG-2	LFG2251FT-P-M1360VG-3
1445	56.89	LFG2251FT-P-M1445VG	LFG2251FT-P-M1445VG-2	LFG2251FT-P-M1445VG-3
1530	60.24	LFG2251FT-P-M1530VG	LFG2251FT-P-M1530VG-2	LFG2251FT-P-M1530VG-3
1615	63.58	LFG2251FT-P-M1615VG	LFG2251FT-P-M1615VG-2	LFG2251FT-P-M1615VG-3
1700	66.93	LFG2251FT-P-M1700VG	LFG2251FT-P-M1700VG-2	LFG2251FT-P-M1700VG-3
1785	70.28	LFG2251FT-P-M1785VG	LFG2251FT-P-M1785VG-2	LFG2251FT-P-M1785VG-3
1870	73.62	LFG2251FT-P-M1870VG	LFG2251FT-P-M1870VG-2	LFG2251FT-P-M1870VG-3

Other widths available on request.

Chains & sprockets	Wear strips	Side guide brackets & accessories	Levelers	Engineering manual
Modular belts & sprockets	Chain & belt return systems	Frame & structure supports	Bearing supports	
Curves & tracks	Side guide solutions	Miscellaneous products	Equipment	



30490d

www.SystemPlastSmartGuide.com

25,4 mm (1") MODULAR BELTS - THICKNESS: 12,7 mm (½")

VERSIONS WITH TWIN POSITIONERS / RUBBER INSERTS

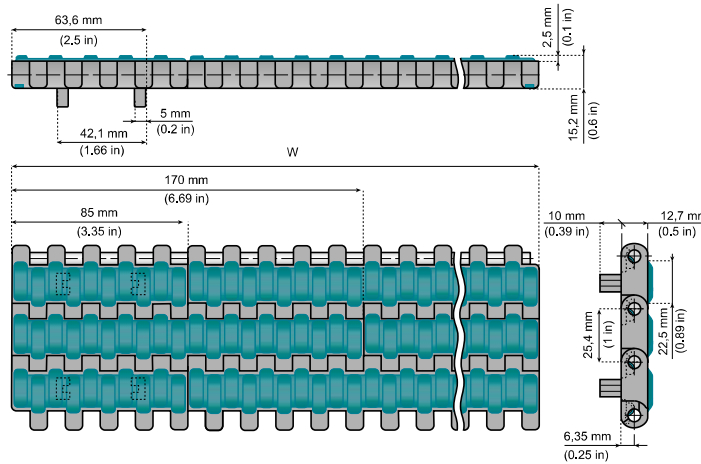

Belt material: low friction acetal resin, grey colour

Rubber material: thermoplastic rubber, waterblue colour, 70 shore A.

Backflex radius: 30 mm (1.18 in)

Max load capacity: 38000 N/m (2600 lbs/ft.)

Pin material: PBT (white)

Standard length:

width ≤ 340 mm (13.39 in): 3,048 m (10 ft.)

width > 340 mm (13.39 in) ≤ 935 mm (36.81 in): 1,524 m (5 ft.)

width > 935 mm (36.81 in): on request



Also available with side indent. Go to:

30495a



Information about this product is only available on our Smart Guide® website.

Standard material

LFG (GREY)

Low friction acetal resin

materials details:

73563a

TPR (WATER BLUE)

Thermoplastic rubber

materials details:

73570a

Other versions for 25,4 mm (1") belts:

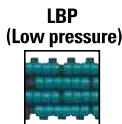

Notes: Schematic presentation of all VG rubber insert 25,4 mm (1") pitch belts. Thickness: 12,7 mm (½")

VG 2251 P2
Insert every pitch

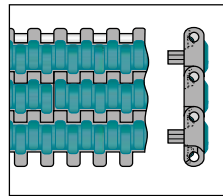

Weight:
13,5 Kg/m² (2.75 lbs/ft²)

VG2 2251 P2
Insert every 2nd pitch

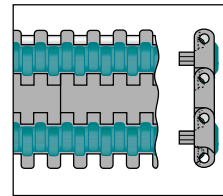

Weight:
13,0 (2.65 lbs/ft²)

VG3 2251 P3
Insert every 3th pitch

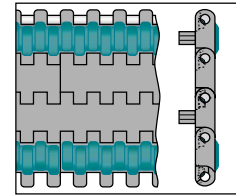

Weight:
12,8 Kg/m² (2.61 lbs/ft²)

WIDTH W		ITEM DESCRIPTION		ITEM DESCRIPTION		ITEM DESCRIPTION	
mm	in						
85	3.35	LFG2251FT-PT-M0085VG	LFG2251FT-PT-M0085VG-2	LFG2251FT-PT-M0085VG-3			
170	6.69	LFG2251FT-PT-M0170VG	LFG2251FT-PT-M0170VG-2	LFG2251FT-PT-M0170VG-3			
255	10.04	LFG2251FT-PT-M0255VG	LFG2251FT-PT-M0255VG-2	LFG2251FT-PT-M0255VG-3			
340	13.39	LFG2251FT-PT-M0340VG	LFG2251FT-PT-M0340VG-2	LFG2251FT-PT-M0340VG-3			
425	16.73	LFG2251FT-PT-M0425VG	LFG2251FT-PT-M0425VG-2	LFG2251FT-PT-M0425VG-3			
510	20.08	LFG2251FT-PT-M0510VG	LFG2251FT-PT-M0510VG-2	LFG2251FT-PT-M0510VG-3			
595	23.43	LFG2251FT-PT-M0595VG	LFG2251FT-PT-M0595VG-2	LFG2251FT-PT-M0595VG-3			
680	26.77	LFG2251FT-PT-M0680VG	LFG2251FT-PT-M0680VG-2	LFG2251FT-PT-M0680VG-3			
765	30.12	LFG2251FT-PT-M0765VG	LFG2251FT-PT-M0765VG-2	LFG2251FT-PT-M0765VG-3			
850	33.46	LFG2251FT-PT-M0850VG	LFG2251FT-PT-M0850VG-2	LFG2251FT-PT-M0850VG-3			
935	36.81	LFG2251FT-PT-M0935VG	LFG2251FT-PT-M0935VG-2	LFG2251FT-PT-M0935VG-3			
1020	40.16	LFG2251FT-PT-M1020VG	LFG2251FT-PT-M1020VG-2	LFG2251FT-PT-M1020VG-3			
1105	43.50	LFG2251FT-PT-M1105VG	LFG2251FT-PT-M1105VG-2	LFG2251FT-PT-M1105VG-3			
1190	46.85	LFG2251FT-PT-M1190VG	LFG2251FT-PT-M1190VG-2	LFG2251FT-PT-M1190VG-3			
1275	50.20	LFG2251FT-PT-M1275VG	LFG2251FT-PT-M1275VG-2	LFG2251FT-PT-M1275VG-3			
1360	53.54	LFG2251FT-PT-M1360VG	LFG2251FT-PT-M1360VG-2	LFG2251FT-PT-M1360VG-3			
1445	56.89	LFG2251FT-PT-M1445VG	LFG2251FT-PT-M1445VG-2	LFG2251FT-PT-M1445VG-3			
1530	60.24	LFG2251FT-PT-M1530VG	LFG2251FT-PT-M1530VG-2	LFG2251FT-PT-M1530VG-3			
1615	63.58	LFG2251FT-PT-M1615VG	LFG2251FT-PT-M1615VG-2	LFG2251FT-PT-M1615VG-3			
1700	66.93	LFG2251FT-PT-M1700VG	LFG2251FT-PT-M1700VG-2	LFG2251FT-PT-M1700VG-3			
1785	70.28	LFG2251FT-PT-M1785VG	LFG2251FT-PT-M1785VG-2	LFG2251FT-PT-M1785VG-3			
1870	73.62	LFG2251FT-PT-M1870VG	LFG2251FT-PT-M1870VG-2	LFG2251FT-PT-M1870VG-3			

Other widths available on request.



Chains & sprockets	Wear strips	Side guide brackets & accessories	Levelers	Engineering manual
Modular belts & sprockets	Chain & belt return systems	Frame & structure supports	Bearing supports	
Curves & tracks	Side guide solutions	Miscellaneous products	Equipment	



3 0 4 9 5 a

25,4 mm (1") MODULAR BELTS - THICKNESS: 12,7 mm (½")

www.SystemPlastSmartGuide.com

RUBBER INSERT EVERY PITCH WITH SIDE INDENT

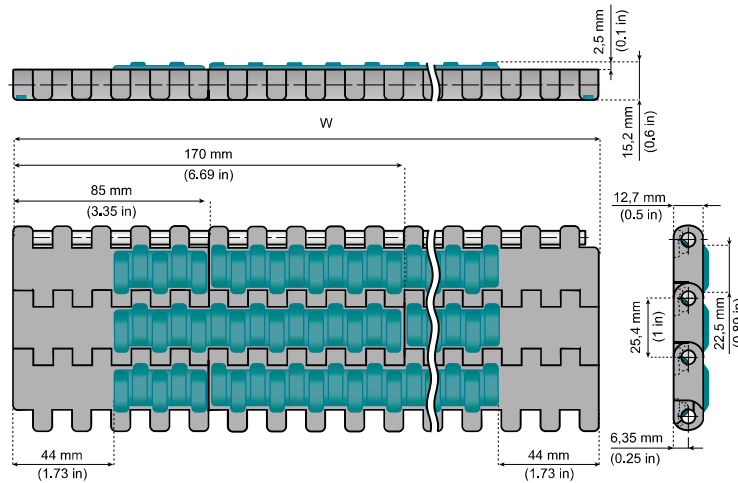

VERSION WITH SIDE INDENT

Belt material: low friction acetal resin, grey colour

Rubber material: thermoplastic rubber, waterblue colour, 70 shore A.

Backflex radius: 30 mm (1.18 in)

Max load capacity: 38000 N/m (2600 lbs/ft.)

Pin material: PBT (white)

Standard length:

width ≤ 340 mm (13.39 in): 3,048 m (10 ft.)

width > 340 mm (13.39 in) ≤ 935 mm (36.81 in): 1,524 m (5 ft.)

width > 935 mm (36.81 in): on request

Standard material

LFG (GREY)

Low friction acetal resin

materials details:

7 3 5 6 3 a

TPR (WATER BLUE)

Thermoplastic rubber

materials details:

7 3 5 7 0 a

Other versions for 25,4 mm (1") belts:

FT
Flat top



FG
Flush grid



LBP
(Low pressure)



Notes: Schematic presentation of all VG rubber insert 25,4 mm (1") pitch belts. Thickness: 12,7 mm (½")



3 0 5 5 0 a

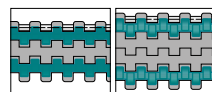

For insert every 2nd or 3th pitch, go to:

3 0 4 9 5 b



For full rubber surface width, go to:

3 0 4 9 0 a



Information about this product is only available on our Smart Guide® website.

VGS 2251 Insert every pitch

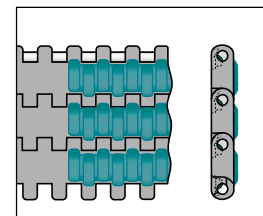

Weight:

13,5 Kg/m² (2.75 lbs/ft²)

WIDTH W		ITEM DESCRIPTION
mm	in	
255	10.04	LFG2251FT-M0255VGS
340	13.39	LFG2251FT-M0340VGS
425	16.73	LFG2251FT-M0425VGS
510	20.08	LFG2251FT-M0510VGS
595	23.43	LFG2251FT-M0595VGS
680	26.77	LFG2251FT-M0680VGS
765	30.12	LFG2251FT-M0765VGS
850	33.46	LFG2251FT-M0850VGS
935	36.81	LFG2251FT-M0935VGS
1020	40.16	LFG2251FT-M1020VGS
1105	43.50	LFG2251FT-M1105VGS
1190	46.85	LFG2251FT-M1190VGS
1275	50.20	LFG2251FT-M1275VGS
1360	53.54	LFG2251FT-M1360VGS
1445	56.89	LFG2251FT-M1445VGS
1530	60.24	LFG2251FT-M1530VGS
1615	63.58	LFG2251FT-M1615VGS
1700	66.93	LFG2251FT-M1700VGS
1785	70.28	LFG2251FT-M1785VGS
1870	73.62	LFG2251FT-M1870VGS

Other widths available on request.



Chains & sprockets	Wear strips	Side guide brackets & accessories	Levelers	Engineering manual
Modular belts & sprockets	Chain & belt return systems	Frame & structure supports	Bearing supports	
Curves & tracks	Side guide solutions	Miscellaneous products	Equipment	

3 0 4 9 5 b

www.SystemPlastSmartGuide.com

25,4 mm (1") MODULAR BELTS - THICKNESS: 12,7 mm (½")

RUBBER INSERT EVERY 2ND & 3TH PITCH WITH SIDE INDENT

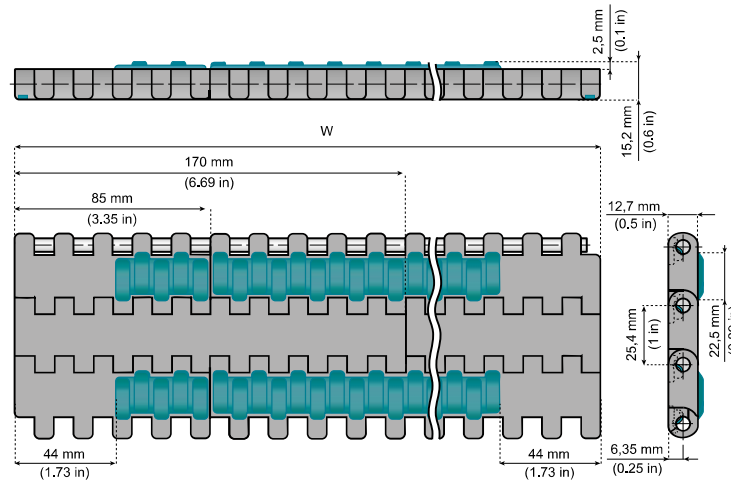
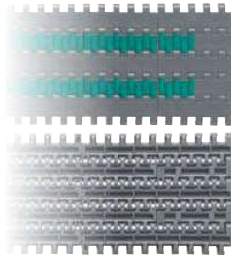

VERSION WITH SIDE INDENT

Belt material: low friction acetal resin, grey colour

Rubber material: thermoplastic rubber, waterblue colour, 70 shore A.

Backflex radius: 30 mm (1.18 in)

Max load capacity: 38000 N/m (2600 lbs/ft.)

Pin material: PBT (white)

Standard length:

width ≤ 340 mm (13.39 in): 3,048 m (10 ft.)

width > 340 mm (13.39 in) ≤ 935 mm (36.81 in): 1,524 m (5 ft.)

width > 935 mm (36.81 in): on request



Standard material

LFG (GREY)

Low friction acetal resin

materials details:



TPR (WATER BLUE)

Thermoplastic rubber

materials details:



Other versions for 25,4 mm (1") belts:

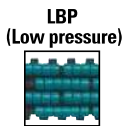

Notes: Schematic presentation of all VG rubber insert 25,4 mm (1") pitch belts. Thickness: 12,7 mm (½")



Information about this product is only available on our Smart Guide® website.

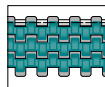

For every insert, go to:



For full rubber surface width. Go to:



VGS2 2251 Insert every 2nd pitch

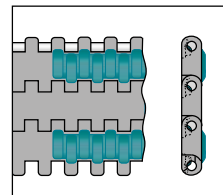

Weight:
13,0 Kg/m² (2.65 lbs/ft²)

VGS3 2251 Insert every 3th pitch

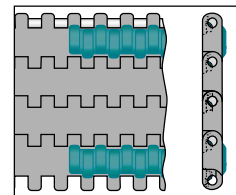

Weight:
12,8 Kg/m² (2.61 lbs/ft²)

WIDTH W		ITEM DESCRIPTION	ITEM DESCRIPTION
mm	in		
170	6.69	LFG2251FT-M0170VGS-2	LFG2251FT-M0170VGS-3
255	10.04	LFG2251FT-M0255VGS-2	LFG2251FT-M0255VGS-3
340	13.39	LFG2251FT-M0340VGS-2	LFG2251FT-M0340VGS-3
425	16.73	LFG2251FT-M0425VGS-2	LFG2251FT-M0425VGS-3
510	20.08	LFG2251FT-M0510VGS-2	LFG2251FT-M0510VGS-3
595	23.43	LFG2251FT-M0595VGS-2	LFG2251FT-M0595VGS-3
680	26.77	LFG2251FT-M0680VGS-2	LFG2251FT-M0680VGS-3
765	30.12	LFG2251FT-M0765VGS-2	LFG2251FT-M0765VGS-3
850	33.46	LFG2251FT-M0850VGS-2	LFG2251FT-M0850VGS-3
935	36.81	LFG2251FT-M0935VGS-2	LFG2251FT-M0935VGS-3
1020	40.16	LFG2251FT-M1020VGS-2	LFG2251FT-M1020VGS-3
1105	43.50	LFG2251FT-M1105VGS-2	LFG2251FT-M1105VGS-3
1190	46.85	LFG2251FT-M1190VGS-2	LFG2251FT-M1190VGS-3
1275	50.20	LFG2251FT-M1275VGS-2	LFG2251FT-M1275VGS-3
1360	53.54	LFG2251FT-M1360VGS-2	LFG2251FT-M1360VGS-3
1445	56.89	LFG2251FT-M1445VGS-2	LFG2251FT-M1445VGS-3
1530	60.24	LFG2251FT-M1530VGS-2	LFG2251FT-M1530VGS-3
1615	63.58	LFG2251FT-M1615VGS-2	LFG2251FT-M1615VGS-3
1700	66.93	LFG2251FT-M1700VGS-2	LFG2251FT-M1700VGS-3
1785	70.28	LFG2251FT-M1785VGS-2	LFG2251FT-M1785VGS-3
1870	73.62	LFG2251FT-M1870VGS-2	LFG2251FT-M1870VGS-3

Other widths available on request.

Chains & sprockets	Wear strips	Side guide brackets & accessories	Levelers	Engineering manual
Modular belts & sprockets	Chain & belt return systems	Frame & structure supports	Bearing supports	
Curves & tracks	Side guide solutions	Miscellaneous products	Equipment	

30495d

25,4 mm (1") MODULAR BELTS - THICKNESS: 12,7 mm (½")

www.SystemPlastSmartGuide.com

VERSIONS WITH TWIN POSITIONERS AND SIDE INDENT / RUBBER INSERTS

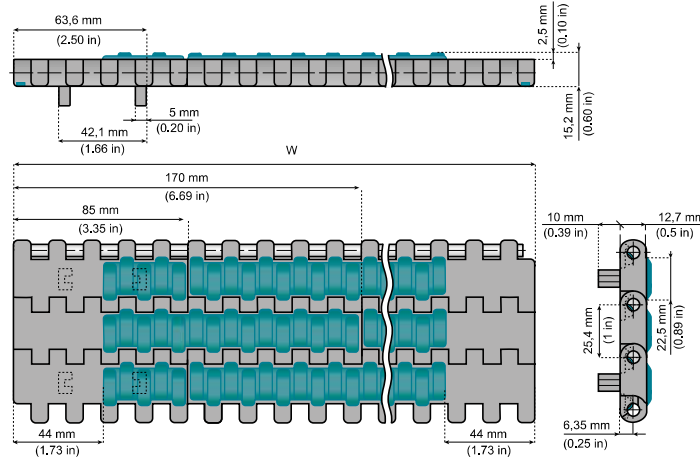

VERSION WITH SIDE INDENT

Belt material: low friction acetal resin, grey colour

Rubber material: thermoplastic rubber, waterblue colour, 70 shore A.

Backflex radius: 30 mm (1.18 in)

Max load capacity: 38000 N/m (2600 lbs/ft.)

Pin material: PBT (white)

Standard length:

width ≤ 340 mm (13.39 in): 3,048 m (10 ft.)

width > 340 mm (13.39 in) ≤ 935 mm (36.81 in): 1,524 m (5 ft.)

width > 935 mm (36.81 in): on request



For full rubber surface width. Go to:

30490a

Standard material

LFG (GREY)

Low friction acetal resin

materials details:

73563a

TPR (WATER BLUE)

Thermoplastic rubber

materials details:

73570a

Other versions for 25,4 mm (1") belts:

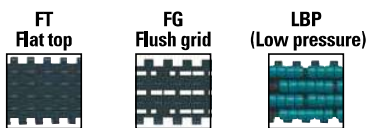

Notes: Schematic presentation of all VG rubber insert 25,4 mm (1") pitch belts. Thickness: 12,7 mm (½")



Information about this product is only available on our Smart Guide® website.

VGS 2251 P2
Insert every pitch

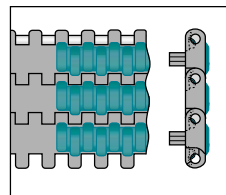

Weight:
13,5 Kg/m² (2.75 lbs/ft²)

VGS2 2251 P2
Insert every 2nd pitch

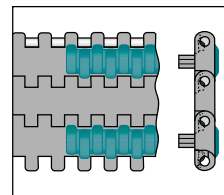

Weight:
13,0 (2.65 lbs/ft²)

VGS3 2251 P2
Insert every 3th pitch

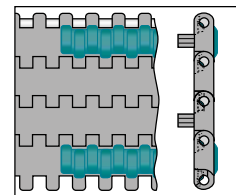

Weight:
12,8 Kg/m² (2.61 lbs/ft²)

WIDTH W		ITEM DESCRIPTION	ITEM DESCRIPTION	ITEM DESCRIPTION
mm	in			
170	6.69	-	LFG2251FT-PT-M0170VGS-2	-
255	10.04	LFG2251FT-PT-M0255VGS	LFG2251FT-PT-M0255VGS-2	LFG2251FT-PT-M0255VGS-3
340	13.39	LFG2251FT-PT-M0340VGS	LFG2251FT-PT-M0340VGS-2	LFG2251FT-PT-M0340VGS-3
425	16.73	LFG2251FT-PT-M0425VGS	LFG2251FT-PT-M0425VGS-2	LFG2251FT-PT-M0425VGS-3
510	20.08	LFG2251FT-PT-M0510VGS	LFG2251FT-PT-M0510VGS-2	LFG2251FT-PT-M0510VGS-3
595	23.43	LFG2251FT-PT-M0595VGS	LFG2251FT-PT-M0595VGS-2	LFG2251FT-PT-M0595VGS-3
680	26.77	LFG2251FT-PT-M0680VGS	LFG2251FT-PT-M0680VGS-2	LFG2251FT-PT-M0680VGS-3
765	30.12	LFG2251FT-PT-M0765VGS	LFG2251FT-PT-M0765VGS-2	LFG2251FT-PT-M0765VGS-3
850	33.46	LFG2251FT-PT-M0850VGS	LFG2251FT-PT-M0850VGS-2	LFG2251FT-PT-M0850VGS-3
935	36.81	LFG2251FT-PT-M0935VGS	LFG2251FT-PT-M0935VGS-2	LFG2251FT-PT-M0935VGS-3
1020	40.16	LFG2251FT-PT-M1020VGS	LFG2251FT-PT-M1020VGS-2	LFG2251FT-PT-M1020VGS-3
1105	43.50	LFG2251FT-PT-M1105VGS	LFG2251FT-PT-M1105VGS-2	LFG2251FT-PT-M1105VGS-3
1190	46.85	LFG2251FT-PT-M1190VGS	LFG2251FT-PT-M1190VGS-2	LFG2251FT-PT-M1190VGS-3
1275	50.20	LFG2251FT-PT-M1275VGS	LFG2251FT-PT-M1275VGS-2	LFG2251FT-PT-M1275VGS-3
1360	53.54	LFG2251FT-PT-M1360VGS	LFG2251FT-PT-M1360VGS-2	LFG2251FT-PT-M1360VGS-3
1445	56.89	LFG2251FT-PT-M1445VGS	LFG2251FT-PT-M1445VGS-2	LFG2251FT-PT-M1445VGS-3
1530	60.24	LFG2251FT-PT-M1530VGS	LFG2251FT-PT-M1530VGS-2	LFG2251FT-PT-M1530VGS-3
1615	63.58	LFG2251FT-PT-M1615VGS	LFG2251FT-PT-M1615VGS-2	LFG2251FT-PT-M1615VGS-3
1700	66.93	LFG2251FT-PT-M1700VGS	LFG2251FT-PT-M1700VGS-2	LFG2251FT-PT-M1700VGS-3
1785	70.28	LFG2251FT-PT-M1785VGS	LFG2251FT-PT-M1785VGS-2	LFG2251FT-PT-M1785VGS-3
1870	73.62	LFG2251FT-PT-M1870VGS	LFG2251FT-PT-M1870VGS-2	LFG2251FT-PT-M1870VGS-3

Other widths available on request.

Chains & sprockets	Wear strips	Side guide brackets & accessories	Levelers	Engineering manual
Modular belts & sprockets	Chain & belt return systems	Frame & structure supports	Bearing supports	
Curves & tracks	Side guide solutions	Miscellaneous products	Equipment	

30500a

25,4 mm (1") MODULAR BELTS 2251LBP - THICKNESS: 12,7 mm (1/2")

www.SystemPlastSmartGuide.com

LOW NOISE ACCUMULATION ROLLERS

LFG



New
NG
evo

NG® evo conveyor components
made from engineered plastic resin

- Longer wearlife than acetal
- Lower friction than acetal
- Good chemical resistance
- High abrasion resistance
- It meets the requirement for materials as stated by EC1935/2004 and FDA CFR21 norms for direct food contact
- Less dust than with acetal chains
- More.....

Backflex radius: 120 mm (4.72 in)

Max load capacity: 34200 N/m (2340 lbs/ft.)

Weight: 28,8 Kg/m² (5.88 lbs/ft².)

Pin material: PBT (white)

Roller shaft material: Stainless Steel AISI 304

Standard length:

width ≤ 340 mm (13.39 in): 1,524 m (5 ft.)

width > 340 mm (13.39 in) ≤ 935 mm (36.81 in): 0,762 m (0.03 in)

width > 935 mm (36.81 in): on request

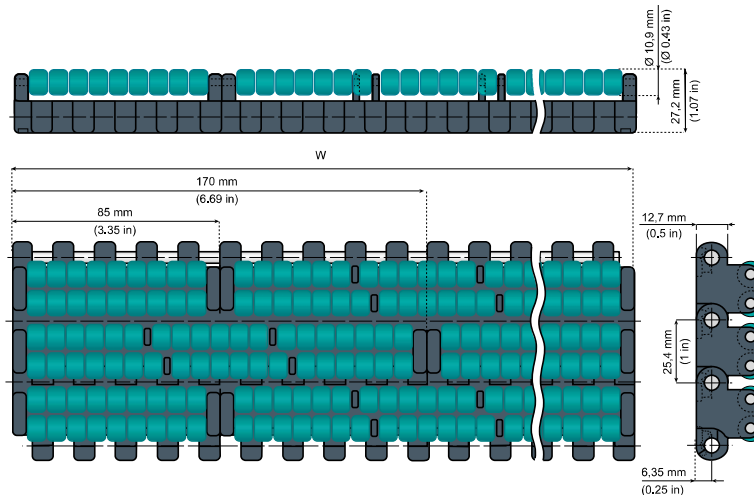

ROLLER GUIDE



For roller guides.
Go to:

52510a



Information about
this product is only available
on our Smart Guide® website.



30550a

Standard materials

NGE (GREY BLUE)	LFG (GREY)
New Generation®	Low friction acetal resin

materials details:

73563a

WIDTH W		ITEM DESCRIPTION	
mm	in	NGE (GREY BLUE)	LFG (GREY)
85	3.35	NGE2251LBP-M0085	LFG2251LBP-M0085
170	6.69	NGE2251LBP-M0170	LFG2251LBP-M0170
255	10.04	NGE2251LBP-M0255	LFG2251LBP-M0255
340	13.39	NGE2251LBP-M0340	LFG2251LBP-M0340
425	16.73	NGE2251LBP-M0425	LFG2251LBP-M0425
510	20.08	NGE2251LBP-M0510	LFG2251LBP-M0510
595	23.43	NGE2251LBP-M0595	LFG2251LBP-M0595
680	26.77	NGE2251LBP-M0680	LFG2251LBP-M0680
765	30.12	NGE2251LBP-M0765	LFG2251LBP-M0765
850	33.46	NGE2251LBP-M0850	LFG2251LBP-M0850
935	36.81	NGE2251LBP-M0935	LFG2251LBP-M0935
1020	40.16	NGE2251LBP-M1020	LFG2251LBP-M1020
1105	43.50	NGE2251LBP-M1105	LFG2251LBP-M1105
1190	46.85	NGE2251LBP-M1190	LFG2251LBP-M1190
1275	50.20	NGE2251LBP-M1275	LFG2251LBP-M1275
1360	53.54	NGE2251LBP-M1360	LFG2251LBP-M1360

Wider widths available upon request. LBP belts cannot be cut-to-width.

Other versions
for 25,4 mm (1") belts:

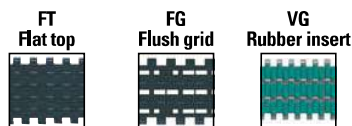

Notes: Schematic presentation of
all LBP low pressure 25,4 mm (1")
pitch belts. Thickness: 12,7 mm (1/2")

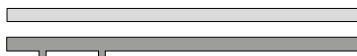

Chains & sprockets	Wear strips	Side guide brackets & accessories	Levelers	Engineering manual
Modular belts & sprockets	Chain & belt return systems	Frame & structure supports	Bearing supports	
Curves & tracks	Side guide solutions	Miscellaneous products	Equipment	

30500b

25,4 mm (1") MODULAR BELTS 2251LBP - THICKNESS: 12,7 mm (½")

www.SystemPlastSmartGuide.com

LOW NOISE ACCUMULATION ROLLERS



2251 LBP PT

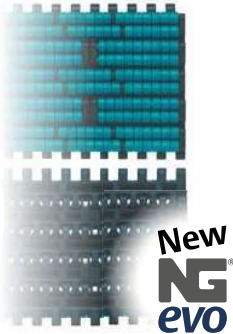

New
NG evo

NG® evo conveyor components made from engineered plastic resin

- Longer wearlife than acetal
- Lower friction than acetal
- Good chemical resistance
- High abrasion resistance
- It meets the requirement for materials as stated by EC1935/2004 and FDA CFR21 norms for direct food contact
- Less dust than with acetal chains
- More.....

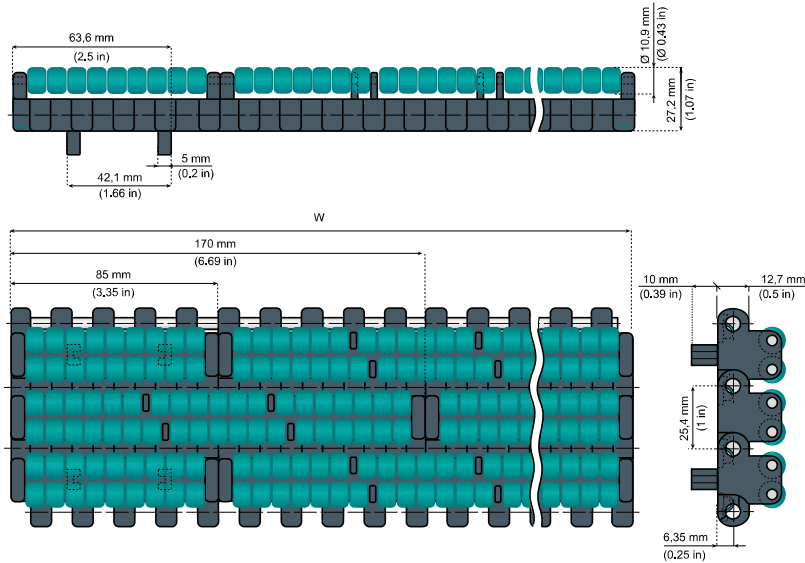

Backflex radius: 120 mm (4.72 in)

Max load capacity: 34200 N/m (2340 lbs/ft.)

Weight: 28,8 Kg/m² (5.88 lbs/ft²)

Pin material: PBT (white)

Roller shaft material: Stainless Steel AISI 304

Standard length:

width ≤ 340 mm (13.39 in): 1,524 m (5 ft.)

width > 340 mm (13.39 in) ≤ 935 mm (36.81 in): 0,762 m (0,03 in)

width > 935 mm (36.81 in): on request

ROLLER GUIDE

For roller guides.
Go to:

52510a

Other versions for 25,4 mm (1") belts:

FT Flat top	FG Flush grid	VG Rubber insert

Notes: Schematic presentation of all LBP low pressure 25,4 mm (1") pitch belts. Thickness: 12,7 mm (½")



Information about this product is only available on our Smart Guide® website.

Standard material

NGE (GREY BLUE)

New Generation®

materials details:



WIDTH W		ITEM DESCRIPTION
mm	in	
85	3.35	NGE2251LBP-PT-M0085
170	6.69	NGE2251LBP-PT-M0170
255	10.04	NGE2251LBP-PT-M0255
340	13.39	NGE2251LBP-PT-M0340
425	16.73	NGE2251LBP-PT-M0425
510	20.08	NGE2251LBP-PT-M0510
595	23.43	NGE2251LBP-PT-M0595
680	26.77	NGE2251LBP-PT-M0680
765	30.12	NGE2251LBP-PT-M0765
850	33.46	NGE2251LBP-PT-M0850
935	36.81	NGE2251LBP-PT-M0935
1020	40.16	NGE2251LBP-PT-M1020
1105	43.50	NGE2251LBP-PT-M1105
1190	46.85	NGE2251LBP-PT-M1190
1275	50.20	NGE2251LBP-PT-M1275
1360	53.54	NGE2251LBP-PT-M1360

Wider widths available upon request. LBP belts cannot be cut-to-width.

Chains & sprockets	Wear strips	Side guide brackets & accessories	Levelers	Engineering manual
Modular belts & sprockets	Chain & belt return systems	Frame & structure supports	Bearing supports	
Curves & tracks	Side guide solutions	Miscellaneous products	Equipment	

SYSTEM PLAST®



3 0 5 5 0 a

DRIVE AND RETURN SPROCKETS

www.SystemPlastSmartGuide.com

FOR BELTS 2251-2252



Notes:

- Sprockets with single keyway can be used for belt widths up to 680 mm (27-in) and temperature differences of maximum 30°C (86°F).
- For wider belts or bigger temperature differences, sprockets with square bores or round bore with double keyway have to be used.

Drive sprockets are manufactured for a tight fit on the shaft. To order single keyway sprockets capable of floating freely on the shaft, just add the letter "P" (=plus) to the existing Item description. For example, **2251-14R30M-DPS**

Features:

- Split versions: quick and easy replacement.
- Foolproof design.
- Excellent wear and chemical resistance.
- Recyclable.



Information about this product is only available on our Smart Guide® website.

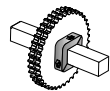

Set collars, go to:

5 4 6 3 0 a



See also the sprockets and idler wheels:

3 0 5 5 0 b



Z	Ø OD mm	Ø P mm	S mm
14	113,68	114,18	50,7
16	130	130,2	58,7
18	146	146,3	66,7
20	162	162,4	74,8



See belts:
1" Pitch (25,4mm)
Thickness=12,7mm.

3 0 4 1 0 a

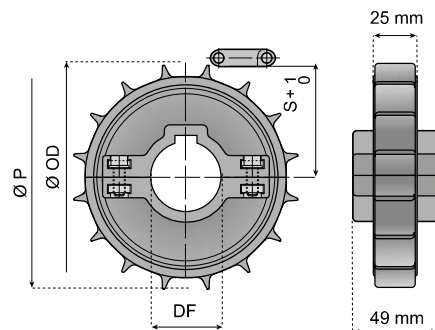

Z	Ø 30	Ø 35	Ø 40	Ø 45
	ITEM DESCRIPTION			
14	2251-14R30M-DS	2251-14R35M-DS	2251-14R40M-DS	-
16	2251-16R30M-DS	2251-16R35M-DS	2251-16R40M-DS	2251-16R45M-DS
18	2251-18R30M-DS	2251-18R35M-DS	2251-18R40M-DS	2251-18R45M-DS
20	2251-20R30M-DS	2251-20R35M-DS	2251-20R40M-DS	2251-20R45M-DS
MOLDED RETURN SPROCKETS - SPLIT				
14	2251-14R30M-RS	2251-14R35M-RS	2251-14R40M-RS	-
16	2251-16R30M-RS	2251-16R35M-RS	2251-16R40M-RS	2251-16R45M-RS
18	2251-18R30M-RS	2251-18R35M-RS	2251-18R40M-RS	2251-18R45M-RS
20	2251-20R30M-RS	2251-20R35M-RS	2251-20R40M-RS	2251-20R45M-RS
MOLDED DRIVE SPROCKETS SQUARE BORE - SPLIT FLOATING				
Z	∅ 30X30	-	∅ 40X40	-
14	-	-	-	-
16	-	-	2251-16S40M-DS	-
18	-	-	2251-18S40M-DS	-
20	-	-	2251-20S40M-DS	-

Material: reinforced polyamide (black), screws in stainless steel, nuts in nickel plated brass.

Chains & sprockets	Wear strips	Side guide brackets & accessories	Levelers	Engineering manual
Modular belts & sprockets	Chain & belt return systems	Frame & structure supports	Bearing supports	
Curves & tracks	Side guide solutions	Miscellaneous products	Equipment	

30550b

DRIVE AND RETURN SPROCKETS

www.SystemPlastSmartGuide.com

FOR BELTS 2251-2252

Notes:

- Sprockets with single keyway can be used for belt widths up to 680 mm (27-in) and temperature differences of maximum 30°C (86°F).
- For wider belts or bigger temperature differences, sprockets with square bores or round bore with double keyway have to be used.

Drive sprockets are manufactured for a tight fit on the shaft. To order single keyway sprockets capable of floating freely on the shaft, just add the letter "P" (=plus) to the existing Item description. For example, **2251-12R25M-DPMS**

New design

30990a

Features:

- Very high strength.
- Split versions: quick and easy replacement.
- Foolproof design.
- Completely closed structure, easy to clean and to disinfect.
- Excellent wear and chemical resistance.
- Recyclable.

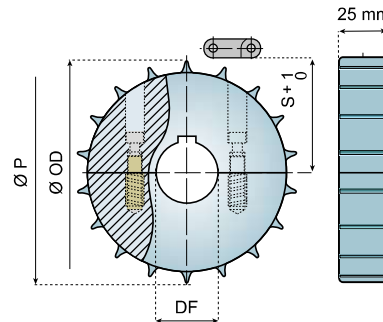

Z	Ø OD mm	Ø P mm	S mm
12	97,9	98,14	42,7
13	105,54	106,14	46,7
14	114	114,18	50,7
15	122,16	122,2	54,6
16	130	130,2	58,7
18	146	146,28	66,7
20	162	162,37	74,8
21	171	170,42	78,9

MACHINED DRIVE SPROCKETS - SPLIT FIXED				
Z	Ø 18* (R18M) Ø 23* (R23M)	Ø 25	Ø 30	Ø 40
ITEM DESCRIPTION				
12	-	2251-12R25M-DMS	2251-12R30M-DMS	2251-12R40M-DMS
13	-	2251-13R25M-DMS	2251-13R30M-DMS	2251-13R40M-DMS
14	-	2251-14R25M-DMS	2251-14R30M-DMS	2251-14R40M-DMS
15	-	2251-15R25M-DMS	2251-15R30M-DMS	2251-15R40M-DMS
16	-	2251-16R25M-DMS	2251-16R30M-DMS	2251-16R40M-DMS
18	-	2251-18R25M-DMS	2251-18R30M-DMS	2251-18R40M-DMS
20	-	2251-20R25M-DMS	2251-20R30M-DMS	2251-20R40M-DMS
21	-	2251-21R25M-DMS	2251-21R30M-DMS	2251-21R40M-DMS
MACHINED RETURN SPROCKETS - SPLIT				
12	2251-12R18M-RMS	2251-12R25M-RMS	2251-12R30M-RMS	2251-12R40M-RMS
13	2251-13R23M-RMS	2251-13R25M-RMS	2251-13R30M-RMS	2251-13R40M-RMS
14	2251-14R23M-RMS	2251-14R25M-RMS	2251-14R30M-RMS	2251-14R40M-RMS
15	2251-15R23M-RMS	2251-15R25M-RMS	2251-15R30M-RMS	2251-15R40M-RMS
16	2251-16R23M-RMS	2251-16R25M-RMS	2251-16R30M-RMS	2251-16R40M-RMS
18	2251-18R23M-RMS	2251-18R25M-RMS	2251-18R30M-RMS	2251-18R40M-RMS
20	2251-20R23M-RMS	2251-20R25M-RMS	2251-20R30M-RMS	2251-20R40M-RMS
21	2251-21R23M-RMS	2251-21R25M-RMS	2251-21R30M-RMS	2251-21R40M-RMS

Material: polyamide (natural white), screws in stainless steel, bushings in brass.
*Plain bore

MACHINED DRIVE SPROCKETS SQUARE BORE - SPLIT FLOATING		
Z	∅ 40X40	∅ 60X60
12	-	-
13	2251-13S40M-DMS	-
14	2251-14S40M-DMS	-
16	2251-16S40M-DMS	2251-16S60M-DMS
18	2251-18S40M-DMS	2251-18S60M-DMS
20	2251-20S40M-DMS	2251-20S60M-DMS
21	2251-21S40M-DMS	2251-21S60M-DMS

Material: polyamide (natural white), screws in stainless steel, bushings in brass.

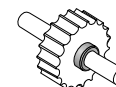

Set collars, go to:

54630a



See belts: 1" Pitch (25,4mm)
Thickness=12,7mm.

30410a



See also the sprockets and idler wheels:

30550a

Chains & sprockets	Wear strips	Side guide brackets & accessories	Levelers	Engineering manual
Modular belts & sprockets	Chain & belt return systems	Frame & structure supports	Bearing supports	
Curves & tracks	Side guide solutions	Miscellaneous products	Equipment	

3 0 6 1 0 a

50,8 mm (2") MODULAR BELTS 2500 - THICKNESS: 16 mm (0.63 in)

www.SystemPlastSmartGuide.com

RAISED RIB BELTS

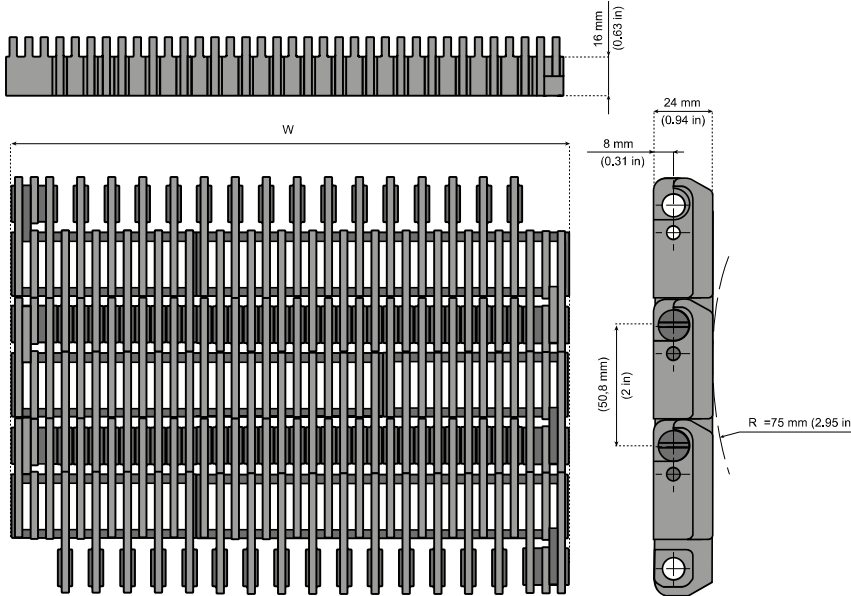

WIDTH W		ITEM DESCRIPTION
mm	in	
229	9.00	PPG2500RR-K900
305	12.00	PPG2500RR-K1200
381	15.00	PPG2500RR-K1500
457	18.00	PPG2500RR-K1800
533	21.00	PPG2500RR-K2100
610	24.00	PPG2500RR-K2400
686	27.00	PPG2500RR-K2700
762	30.00	PPG2500RR-K3000
838	33.00	PPG2500RR-K3300
914	36.00	PPG2500RR-K3600
991	39.00	PPG2500RR-K3900
1067	42.00	PPG2500RR-K4200
1143	45.00	PPG2500RR-K4500
1219	48.00	PPG2500RR-K4800
1295	51.00	PPG2500RR-K5100
1372	54.00	PPG2500RR-K5400
1448	57.00	PPG2500RR-K5700
1524	60.00	PPG2500RR-K6000
1600	63.00	PPG2500RR-K6300
1676	66.00	PPG2500RR-K6600
1753	69.00	PPG2500RR-K6900
1829	72.00	PPG2500RR-K7200
1905	75.00	PPG2500RR-K7500
1981	78.00	PPG2500RR-K7800
2057	81.00	PPG2500RR-K8100
2134	84.00	PPG2500RR-K8400
2210	87.00	PPG2500RR-K8700
2286	90.00	PPG2500RR-K9000
2362	93.00	PPG2500RR-K9300
2438	96.00	PPG2500RR-K9600
2515	99.00	PPG2500RR-K9900
2591	102.00	PPG2500RR-K10200
2667	105.00	PPG2500RR-K10500
2743	108.00	PPG2500RR-K10800
2819	111.00	PPG2500RR-K11100
2896	114.00	PPG2500RR-K11400
2972	117.00	PPG2500RR-K11700
3048	120.00	PPG2500RR-K12000
3124	123.00	PPG2500RR-K12300
3200	126.00	PPG2500RR-K12600
3277	129.00	PPG2500RR-K12900
3353	132.00	PPG2500RR-K13200
3429	135.00	PPG2500RR-K13500
3505	138.00	PPG2500RR-K13800
3581	141.00	PPG2500RR-K14100
3658	144.00	PPG2500RR-K14400
3734	147.00	PPG2500RR-K14700
3810	150.00	PPG2500RR-K15000

Backflex radius: 75 mm (2.95 in)
Max load capacity: 30000 N/m (2000 lbs/ft.)
Weight: 9,2 Kg/m² (1.88 lbs/ft².)
Pin material: Polypropylene
Belt Material: Polypropylene (Dark grey)
Open Surface: 27%.
Standard length:
width ≤ 15 in: 3,048 m (10 ft)
width > 15 in: 1,016 m (40 in)

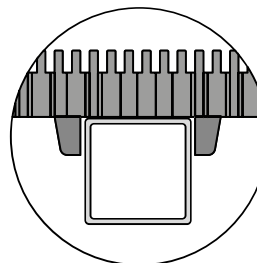

2500RR - Raised Rib modular belts are also available with positioners.
Go to: **7 2 3 1 2 a**

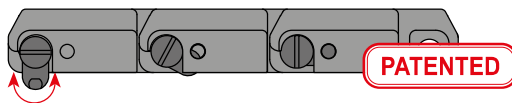

Standard material

PPG (DARK GREY)

Polypropylene

materials details:

7 3 5 6 5 a

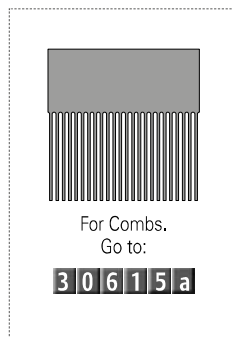

Information about this product is only available on our Smart Guide® website.



Other widths available on request.

Chains & sprockets	Wear strips	Side guide brackets & accessories	Levelers	Engineering manual
Modular belts & sprockets	Chain & belt return systems	Frame & structure supports	Bearing supports	
Curves & tracks	Side guide solutions	Miscellaneous products	Equipment	

30615a

COMBS FOR 2500 RR RAISED RIB BELT 2"

www.SystemPlastSmartGuide.com

ITEM DESCRIPTION	L		LF		LH	
	mm	in	mm	in	mm	in
LFG-COMB2500-M152	152,4	6	63,5	2,5	21,6	0,85
LFG-COMB2500-M190	190,5	7,5	101,3	3,99	38,1	1,5
PAB-COMB2500-M165	165,1	6,5	130,8	5,15	38,1	1,5

Material: LFG - Acetal, Grey.
PAB - Reinforced polyamide, black

Note:

- Use shouldered screws (included) for fixing the comb to the conveyor construction.
- Two caps are supplied with each comb to cover the long holes.

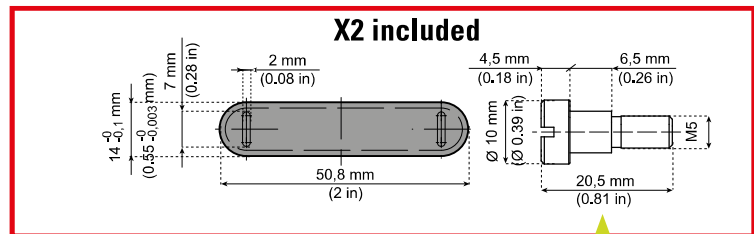
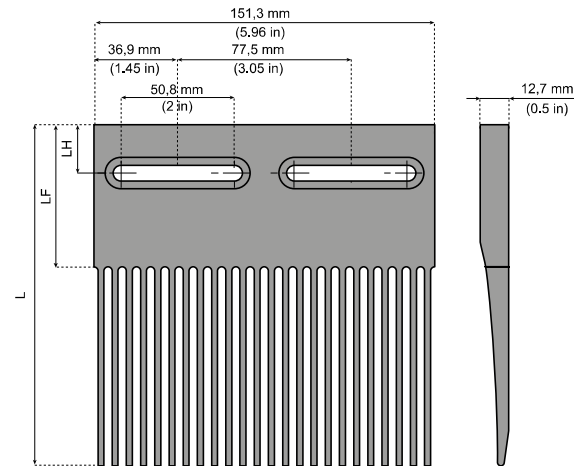

Material: stainless steel.

Shoulder screws are designed to fix the combs to the conveyor construction, but still allow for horizontal movement of the combs. This is required to follow expansion and contraction of the belt. Please consult Technical Support for optimum positioning of the screws.

SHOULDER SCREWS

ITEM DESCRIPTION

SCREW21M5-SS

DRIVE SPROCKETS

FOR BELT 2500RR

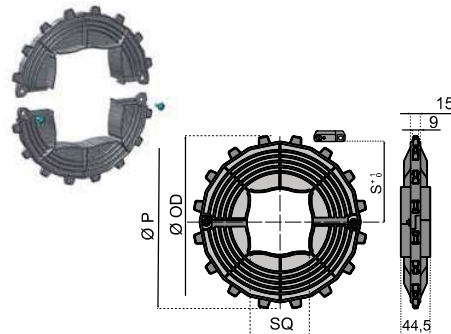

Features:

- Split versions: quick and easy replacement.
- Excellent wear and chemical resistance.
- Recyclable.

MOLDED DRIVE SPROCKETS SQUARE BORE - SPLIT FLOATING

Z	∅ 65X65	∅ 90X90	∅ 120X120	Z	∅ OD mm	∅ P mm	S mm
	ITEM DESCRIPTION						
13	-	2500-13S90M-DS	-	13	213,6	212,3	98
16	2500-16S65M-DS	2500-16S90M-DS	2500-16S120M-DS	16	263,7	260,4	122,3

Material: acetal.

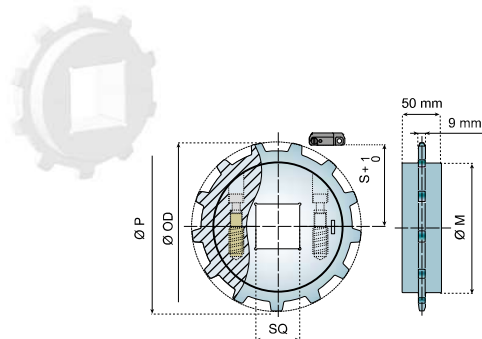

New design 30990a

Features:

- Very high strength.
- Split versions: quick and easy replacement.
- Foolproof design.
- Completely closed structure, easy to clean and to disinfect.
- Excellent wear and chemical resistance.
- Recyclable.

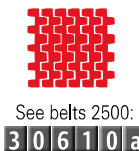

Information about this product is only available on our Smart Guide® website.



See also the sprockets and idler wheels:

30615b

Z	∅ P mm	∅ OD mm	∅ M mm	S mm
10	164,4	165	125	74,2
12	196,3	198	148	90,1
13	212,3	215	164	98,1
14	228,3	231	168	106,1
15	244,3	248	185	114,1

SPLIT SPROCKETS SQUARE BORE FLOATING

Z	∅ 40X40	∅ 60X60	∅ 65X65	∅ 90X90
	ITEM DESCRIPTION			
10	-	2500-10S60M-DMS	2500-10S65M-DMS	-
12	2500-12S40M-DMS	2500-12S60M-DMS	2500-12S65M-DMS	2500-12S90M-DMS
13	-	2500-13S60M-DMS	2500-13S65M-DMS	2500-13S90M-DMS
14	-	2500-14S60M-DMS	2500-14S65M-DMS	2500-14S90M-DMS
15	-	2500-15S60M-DMS	2500-15S65M-DMS	-

Material: polyamide (natural white), screws in stainless steel, bushings in brass.

Chains & sprockets	Wear strips	Side guide brackets & accessories	Levelers	Engineering manual
Modular belts & sprockets	Chain & belt return systems	Frame & structure supports	Bearing supports	
Curves & tracks	Side guide solutions	Miscellaneous products	Equipment	

3 0 6 1 5 b

www.SystemPlastSmartGuide.com

DRIVE AND RETURN SPROCKETS

FOR BELT 2500R

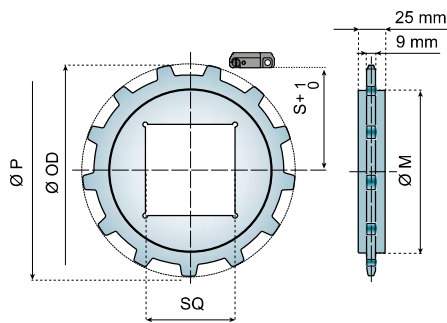

Features:

- Completely closed structure, easy to clean and to disinfect.
- Excellent wear and chemical resistance.
- Recyclable.

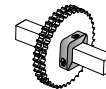

Set collars, go to:

5 4 6 3 0 a

MACHINED DRIVE SPROCKETS SQUARE BORE - ONE PIECE FLOATING	
Z	∇ 40X40
ITEM DESCRIPTION	
10	2500-10S40M-DM

Material: polyamide (natural white).

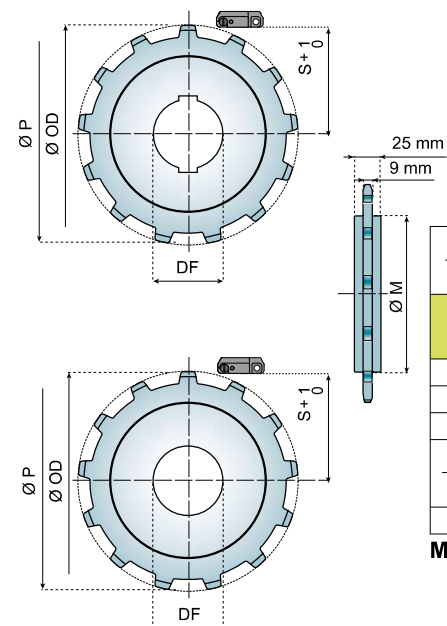

See also the sprockets and idler wheels:

3 0 6 1 5 a

Z	Ø P mm	Ø OD mm	Ø M mm	S mm
10	164,4	165	103	74,2
13	212,3	215	152	98,1
16	260,4	264	185	122,3



See belts 2500:

3 0 6 1 0 a

MACHINED DRIVE SPROCKETS - ONE PIECE DOUBLE KEYWAY - FLOATING			
Z	Ø 40	Ø 65	Ø 90
ITEM DESCRIPTION			
10	-	2500-10R65M-DPM-K2	-
13	-	2500-13R65M-DPM-K2	2500-13R90M-DPM-K2
16	-	2500-16R65M-DPM-K2	2500-16R90M-DPM-K2
MACHINED RETURN SPROCKETS - ONE PIECE			
10	2500-10R40M-RM	-	-

Material: polyamide (natural white).

Chains & sprockets	Wear strips	Side guide brackets & accessories	Levelers	Engineering manual
Modular belts & sprockets	Chain & belt return systems	Frame & structure supports	Bearing supports	
Curves & tracks	Side guide solutions	Miscellaneous products	Equipment	

SYSTEM PLAST®



3 0 6 1 7 a

50,8 mm (2") MODULAR BELTS 2502 - THICKNESS: 12,7 mm (½ in)

www.SystemPlastSmartGuide.com

DRAINING TOP - FILTERING BELT



New

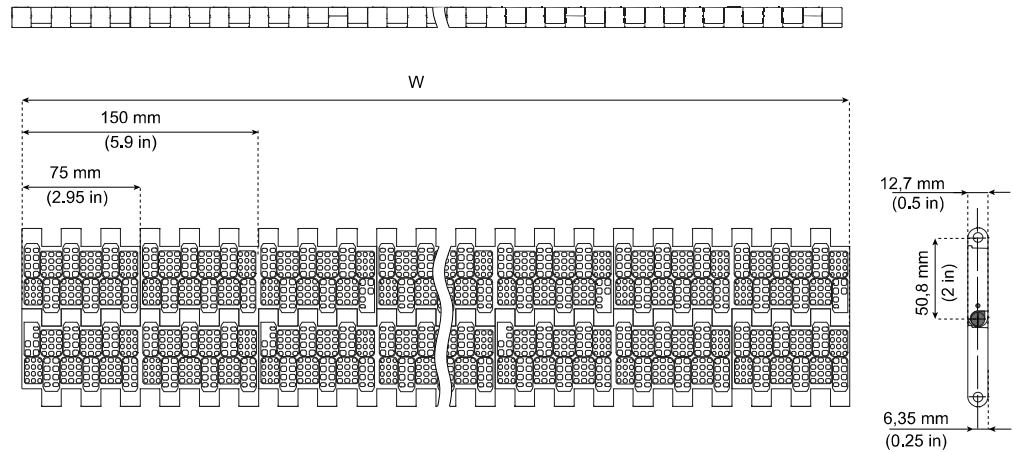

Backflex radius: 10 mm (0.39 in)
Max load capacity: 3000 N/m (2207 lbs/ft.)
Weight: 4,9 Kg/m² (1 lbs/ft.²) for 525 mm width
Pin material: PP (brown)
Standard length: 1,524 m (5 ft.)
Open surface: 37%

WIDTH W		ITEM DESCRIPTION
mm	in	
150	5,91	PPW2502DT-M0150
225	8,86	PPW2502DT-M0225
300	11,81	PPW2502DT-M0300
375	14,76	PPW2502DT-M0375
450	17,72	PPW2502DT-M0450
525	20,67	PPW2502DT-M0525
600	23,62	PPW2502DT-M0600
675	26,57	PPW2502DT-M0675
750	29,53	PPW2502DT-M0750
825	32,48	PPW2502DT-M0825
900	35,43	PPW2502DT-M0900
975	38,39	PPW2502DT-M0975
1050	41,34	PPW2502DT-M1050
1125	44,29	PPW2502DT-M1125
1200	47,24	PPW2502DT-M1200
1275	50,20	PPW2502DT-M1275
1350	53,15	PPW2502DT-M1350
1425	56,10	PPW2502DT-M1425
1500	59,06	PPW2502DT-M1500

Other widths available on request.



Information about this product is only available on our Smart Guide® website.

Standard material

PPW (WHITE)

Polypropylene

materials details:



Chains & sprockets	Wear strips	Side guide brackets & accessories	Levelers	Engineering manual
Modular belts & sprockets	Chain & belt return systems	Frame & structure supports	Bearing supports	
Curves & tracks	Side guide solutions	Miscellaneous products	Equipment	

SYSTEM PLAST®



3 0 6 1 8 a

DRIVE SPROCKETS

www.SystemPlastSmartGuide.com

FOR BELT 2502DT



Features:

- Completely closed structure, easy to clean and to disinfect.
- Excellent wear and chemical resistance.
- Recyclable.

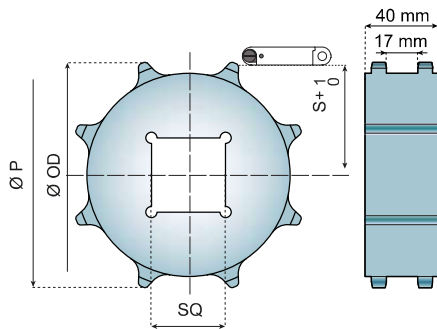

MACHINED DRIVE SPROCKETS SQUARE BORE - ONE PIECE FLOATING			
Z	Ø 40X40	Ø 60X60	Ø 90X90
8	2502-8S40M-DM	-	-
10	2502-10S40M-DM	2502-10S60M-DM	-
12	-	2502-12S60M-DM	2502-12S90M-DM

Z	Ø OD mm	Ø P mm	S mm
8	132	132,4	55,2
10	163,4	164,4	72,3
12	196,1	196,3	88,8

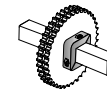

Set collars, go to:

5 4 6 3 0 a



See belts 2502DT:

3 0 6 1 7 a

Material: polyamide (natural white).

Chains & sprockets	Wear strips	Side guide brackets & accessories	Levelers	Engineering manual
Modular belts & sprockets	Chain & belt return systems	Frame & structure supports	Bearing supports	
Curves & tracks	Side guide solutions	Miscellaneous products	Equipment	

SYSTEM PLAST®



3 0 6 2 0 a

50,8 mm (2") MODULAR BELTS 2508 - THICKNESS: 22 mm (0.87 in)

www.SystemPlastSmartGuide.com

FLAT TOP WITH ANTI-SLIP SURFACE

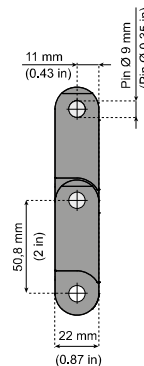
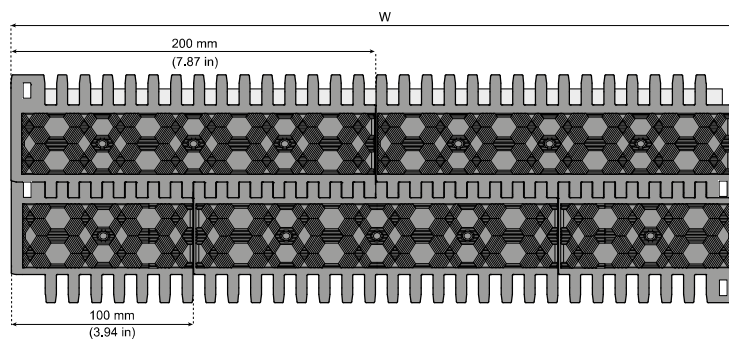

PATENTED

3 0 6 4 0 a

VERSION STANDARD (LFG MATERIAL)

Strength and weight data for other materials available on request.

Backflex radius: 55 mm (2.17 in)

Max load capacity: 80 kN/m (5440 lbs)

Weight: 22,5 kg/m² (4.59 lbs/ft².)

Standard length:

width ≤ 800 mm (31.5 in): 20 pitches (1,016 m)

width > 800 mm (31.5 in): 15 pitches (0,762 m)

Pin material: PBT (white).

Steel pins optionally available.



Information about this product is only available on our Smart Guide® website.

Standard material

LFG (GREY)

Low friction acetal resin

materials details:

7 3 5 6 3 a

Also available into

PPLG (LIGHT GREY)

Polypropylene

POM-AS (BLACK)

Anti-static acetal

PP-FR-EC (BLACK)

Flame retardant electrically conductive polypropylene

materials details:

7 2 3 3 6 a

WIDTH W		ITEM DESCRIPTION
mm	in	
300	11.81	LFG2508FTS-M0300
400	15.75	LFG2508FTS-M0400
500	19.69	LFG2508FTS-M0500
600	23.62	LFG2508FTS-M0600
700	27.56	LFG2508FTS-M0700
800	31.50	LFG2508FTS-M0800
900	35.43	LFG2508FTS-M0900
1000	39.37	LFG2508FTS-M1000
1100	43.31	LFG2508FTS-M1100
1200	47.24	LFG2508FTS-M1200
1300	51.18	LFG2508FTS-M1300
1400	55.12	LFG2508FTS-M1400
1500	59.06	LFG2508FTS-M1500
1600	62.99	LFG2508FTS-M1600
1700	66.93	LFG2508FTS-M1700
1800	70.87	LFG2508FTS-M1800
1900	74.80	LFG2508FTS-M1900
2000	78.74	LFG2508FTS-M2000
2100	82.68	LFG2508FTS-M2100
2200	86.61	LFG2508FTS-M2200
2300	90.55	LFG2508FTS-M2300
2400	94.49	LFG2508FTS-M2400
2500	98.43	LFG2508FTS-M2500
2600	102.36	LFG2508FTS-M2600
2700	106.30	LFG2508FTS-M2700
2800	110.24	LFG2508FTS-M2800
2900	114.17	LFG2508FTS-M2900
3000	118.11	LFG2508FTS-M3000
3100	122.05	LFG2508FTS-M3100
3200	125.98	LFG2508FTS-M3200
3300	129.92	LFG2508FTS-M3300
3400	133.86	LFG2508FTS-M3400
3500	137.80	LFG2508FTS-M3500
3600	141.73	LFG2508FTS-M3600
3700	145.67	LFG2508FTS-M3700
3800	149.61	LFG2508FTS-M3800
3900	153.54	LFG2508FTS-M3900
4000	157.48	LFG2508FTS-M4000
4100	161.42	LFG2508FTS-M4100
4200	165.35	LFG2508FTS-M4200
4300	169.29	LFG2508FTS-M4300
4400	173.23	LFG2508FTS-M4400
4500	177.17	LFG2508FTS-M4500
4600	181.10	LFG2508FTS-M4600
4700	185.04	LFG2508FTS-M4700
4800	188.98	LFG2508FTS-M4800
4900	192.91	LFG2508FTS-M4900
5000	196.85	LFG2508FTS-M5000

Other widths available on request.

Chains & sprockets	Wear strips	Side guide brackets & accessories	Levelers	Engineering manual
Modular belts & sprockets	Chain & belt return systems	Frame & structure supports	Bearing supports	
Curves & tracks	Side guide solutions	Miscellaneous products	Equipment	

3 0 6 4 0 a

DRIVE SPROCKETS

www.SystemPlastSmartGuide.com

FOR BELT 2508

The sprockets for 2508 series have a polygonal shape to provide optimum belt support. This is important for belts that have a large pitch and work with very high loads.

Features:

- Completely closed structure, easy to clean and to disinfect.
- Excellent wear and chemical resistance.
- Recyclable.

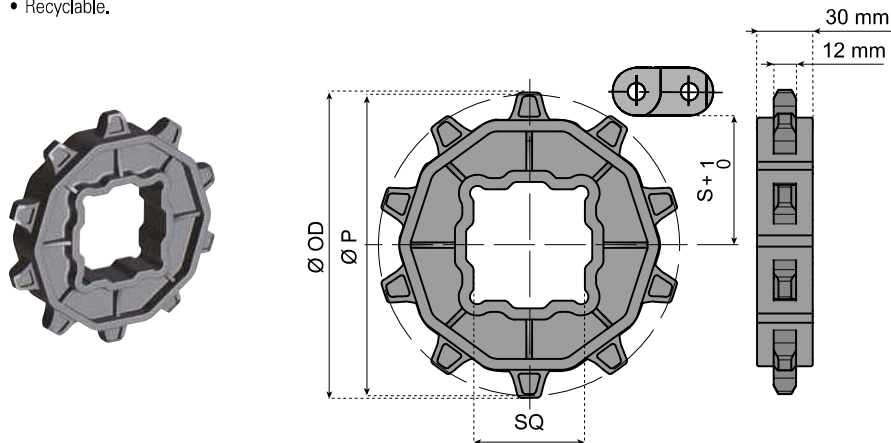

MOLDED DRIVE SPROCKETS SQUARE BORE - ONE PIECE FLOATING		
Z	∅ 60X60	∅ 90X90
ITEM DESCRIPTION		
10	2508-10S60M-D	-
12	2508-12S60M-D	2508-12S90M-D
16	2508-16S60M-D	2508-16S90M-D

Z	∅ OD mm	∅ P mm	S mm
10	160,4	164,39	71,7
12	193,6	196,28	87,6
16	259,4	260,39	119,7



See belts 2508:

3 0 6 2 0 a

Material: reinforced polyamide (black).

On request we can also provide machined sprockets with a different number of teeth or a different bore size.

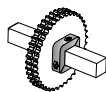

Set collars, go to:

5 4 6 3 0 a

Chains & sprockets	Wear strips	Side guide brackets & accessories	Levelers	Engineering manual
Modular belts & sprockets	Chain & belt return systems	Frame & structure supports	Bearing supports	
Curves & tracks	Side guide solutions	Miscellaneous products	Equipment	

SYSTEM PLAST®



PATENTED

3 0 6 4 5 a

63,5 mm (2 1/2") MODULAR BELTS 2630 - THICKNESS: 30 mm (1.18 in)

www.SystemPlastSmartGuide.com

FLAT TOP WITH ANTI-SLIP SURFACE

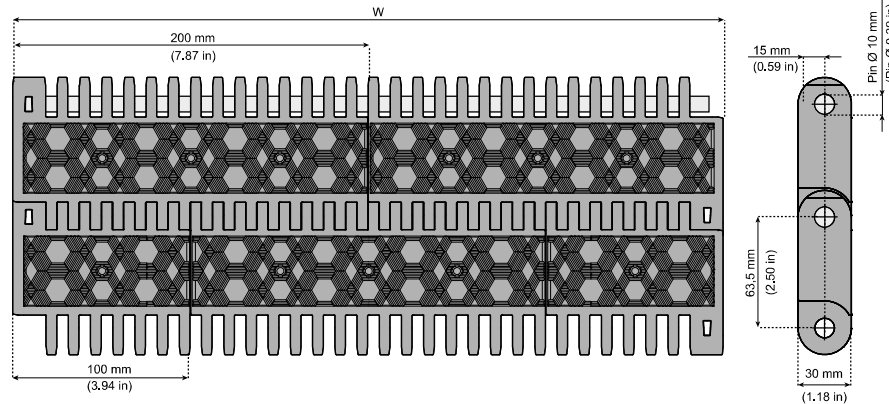

3 0 6 5 0 a

VERSION STANDARD (LFG MATERIAL)

Strength and weight data for other materials available on request.

Backflex radius: 60 mm (2.36 in)

Max load capacity: 115 kN/m (7800 lbs)

Weight: 29,5 kg/m² (6.02 lbs/ft².)

Standard length:

width ≤ 800 mm (31.5 in): 16 pitches (1,016 m)

width > 800 mm (31.5 in): 12 pitches (0,762 m)

Pin material: PBT (white).

Steel pins optionally available.



Information about this product is only available on our Smart Guide® website.

Standard material

LFG (GREY)

Low friction acetal resin

materials details:

7 3 5 6 3 a

Also available into

PPLG (LIGHT GREY)

Polypropylene

POM-AS (BLACK)

Anti-static acetal

PP-FR-EC (BLACK)

Flame retardant electrically conductive polypropylene

materials details:

7 2 3 3 6 a

WIDTH W		ITEM DESCRIPTION
mm	in	
100	3.94	LFG2630FTS-M0100
300	11.81	LFG2630FTS-M0300
400	15.75	LFG2630FTS-M0400
500	19.69	LFG2630FTS-M0500
600	23.62	LFG2630FTS-M0600
700	27.56	LFG2630FTS-M0700
800	31.50	LFG2630FTS-M0800
900	35.43	LFG2630FTS-M0900
1000	39.37	LFG2630FTS-M1000
1100	43.31	LFG2630FTS-M1100
1200	47.24	LFG2630FTS-M1200
1300	51.18	LFG2630FTS-M1300
1400	55.12	LFG2630FTS-M1400
1500	59.06	LFG2630FTS-M1500
1600	62.99	LFG2630FTS-M1600
1700	66.93	LFG2630FTS-M1700
1800	70.87	LFG2630FTS-M1800
1900	74.80	LFG2630FTS-M1900
2000	78.74	LFG2630FTS-M2000
2100	82.68	LFG2630FTS-M2100
2200	86.61	LFG2630FTS-M2200
2300	90.55	LFG2630FTS-M2300
2400	94.49	LFG2630FTS-M2400
2500	98.43	LFG2630FTS-M2500
2600	102.36	LFG2630FTS-M2600
2700	106.30	LFG2630FTS-M2700
2800	110.24	LFG2630FTS-M2800
2900	114.17	LFG2630FTS-M2900
3000	118.11	LFG2630FTS-M3000
3100	122.05	LFG2630FTS-M3100
3200	125.98	LFG2630FTS-M3200
3300	129.92	LFG2630FTS-M3300
3400	133.86	LFG2630FTS-M3400
3500	137.80	LFG2630FTS-M3500
3600	141.73	LFG2630FTS-M3600
3700	145.67	LFG2630FTS-M3700
3800	149.61	LFG2630FTS-M3800
3900	153.54	LFG2630FTS-M3900
4000	157.48	LFG2630FTS-M4000
4100	161.42	LFG2630FTS-M4100
4200	165.35	LFG2630FTS-M4200
4300	169.29	LFG2630FTS-M4300
4400	173.23	LFG2630FTS-M4400
4500	177.17	LFG2630FTS-M4500
4600	181.10	LFG2630FTS-M4600
4700	185.04	LFG2630FTS-M4700
4800	188.98	LFG2630FTS-M4800
4900	192.91	LFG2630FTS-M4900
5000	196.85	LFG2630FTS-M5000

Other widths available on request.

Chains & sprockets	Wear strips	Side guide brackets & accessories	Levelers	Engineering manual
Modular belts & sprockets	Chain & belt return systems	Frame & structure supports	Bearing supports	
Curves & tracks	Side guide solutions	Miscellaneous products	Equipment	

3 0 6 5 0 a

DRIVE SPROCKETS

www.SystemPlastSmartGuide.com

FOR BELT 2630

The sprockets for 2630 series have a polygonal shape to provide optimum belt support. This is important for belts that have a large pitch and work with very high loads.

Features:

- Completely closed structure, easy to clean and to disinfect.
- Excellent wear and chemical resistance.
- Recyclable.

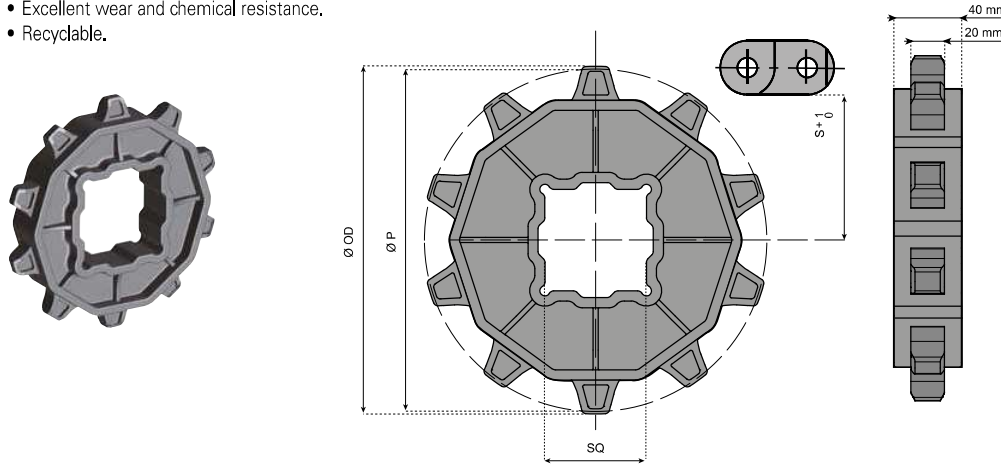

On request we can also provide machined sprockets with a different number of teeth or a different bore size.

MOLDED DRIVE SPROCKETS SQUARE BORE - ONE PIECE FLOATING		
Z	Ø 60X60	Ø 90X90
ITEM DESCRIPTION		
10	2630-10S60M-D	-
13	2630-13S60M-D	2630-13S90M-D
15	2630-15S60M-D	2630-15S90M-D

Z	Ø OD mm	Ø P mm	S mm
10	203,4	205,49	88,2
13	265,3	265,34	118,2
15	306,7	305,42	138,2

Material: reinforced polyamide (black).



See belts 2630:

3 0 6 4 5 a

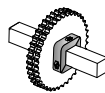

Set collars, go to:

5 4 6 3 0 a

Chains & sprockets	Wear strips	Side guide brackets & accessories	Levelers	Engineering manual
Modular belts & sprockets	Chain & belt return systems	Frame & structure supports	Bearing supports	
Curves & tracks	Side guide solutions	Miscellaneous products	Equipment	

30700a

25,4 mm (1") CHAINBELT

www.SystemPlastSmartGuide.com

FOR MAGNETIC CURVES



2260 M FT

LFG



New
NG
evo

NG® evo conveyor components made from engineered plastic resin

- Longer wearlife than acetal
- Lower friction than acetal
- Good chemical resistance
- High abrasion resistance
- It meets the requirement for materials as stated by EC1935/2004 and FDA CFR21 norms for direct food contact
- Less dust than with acetal chains
- More.....

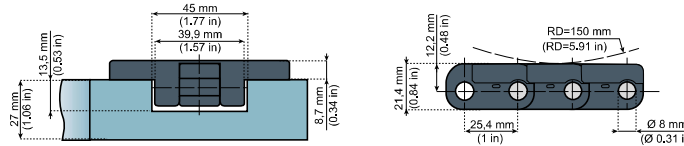

Applications:

The chainbelt magnetic system with closed top plates is best suited for conveying glass and pet containers (for example PET bottles with petaloid base).

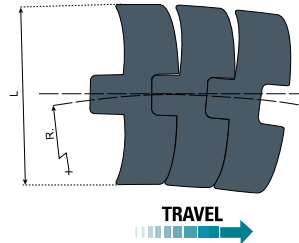

2260M FT - 2260M FG
page code:
50091a

2260 M FG

LFG

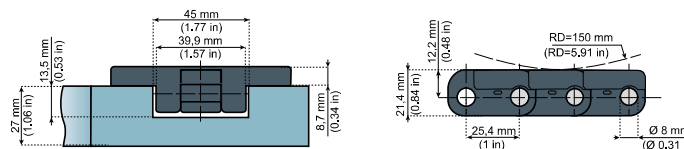

New

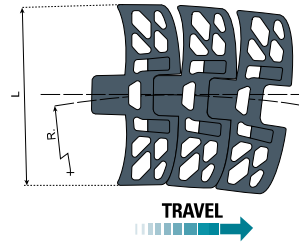

2251M FT
page code:
50101a

Applications:

Flush grid chainbelt for magnetic system with 20% open area is ideal for can conveying applications.



30715a

2251 M FT

LFG



New
NG
evo

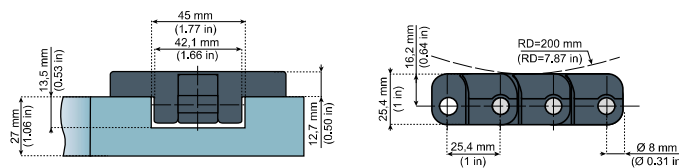

"NOLU-S" CURVES ARE STRONGLY RECOMMENDED WITH THESE CHAINS!

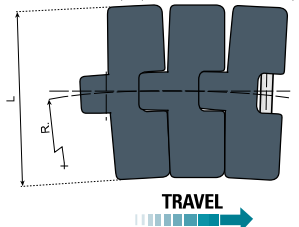

Information about this product is only available on our Smart Guide® website.

Pin Material: Martensitic Stainless Steel

ITEM DESCRIPTION	MATERIAL	WIDTH L		R MIN.	WEIGHT	
		mm	in		Kg/m	lbs/ft.
LFG2260FT-M-K330	LFG Grey	83,8	3,3	500	1,7	1,14
NGE2260FT-M-K330	NGE Grey Blue	83,8	3,3	500	1,7	1,14
New LFG2260FG-M-K330	LFG Grey	83,8	3,3	500	1,6	1,07
NGE2260FG-M-K330	NGE Grey Blue	83,8	3,3	500	1,6	1,07
LFG2251FT-M-K330	LFG Grey	83,8	3,3	500	1,9	1,27
NGE2251FT-M-K330	NGE Grey Blue	83,8	3,3	500	1,9	1,27
LFG2251FT-M-K450	LFG Grey	114,3	4,5	500	2,2	1,48
NGE2251FT-M-K450	NGE Grey Blue	114,3	4,5	500	2,2	1,48

Standard materials

NGE (GREY BLUE)
New Generation®

LFG (GREY)
Low friction acetal resin

materials details:

73563a

Standard length: 120 pitches (3,048 m - 10 ft.) **Max load capacity:** (LFG-FT): 2000N (450lbs) - (LFG-FG): 1900N (425lbs)

Other widths available on request.

Chains & sprockets	Wear strips	Side guide brackets & accessories	Levelers	Engineering manual
Modular belts & sprockets	Chain & belt return systems	Frame & structure supports	Bearing supports	
Curves & tracks	Side guide solutions	Miscellaneous products	Equipment	

SYSTEM PLAST®



30710a

25,4 mm (1") CHAINBELT

www.SystemPlastSmartGuide.com

VERSIONS WITH TABS



2250 TAB FT

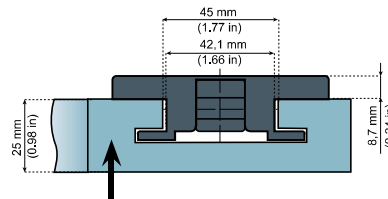

STANDARD TRACKS FOR TAB SYSTEM

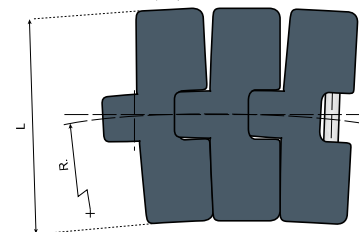
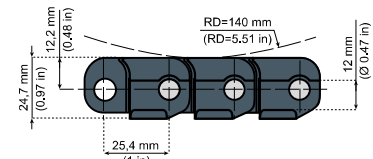

Applications:

The chainbelt magnetic system with closed top plates is best suited for conveying glass and PET containers (for example PET bottles with petaloid base).

Pin material: Austenic Steel

"NOLU-S" CURVES ARE STRONGLY RECOMMENDED WITH THESE CHAINS!

2251 TAB FT

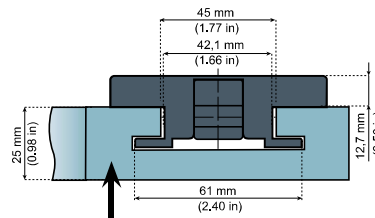

STANDARD TRACKS FOR TAB SYSTEM

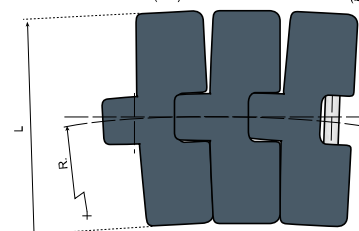
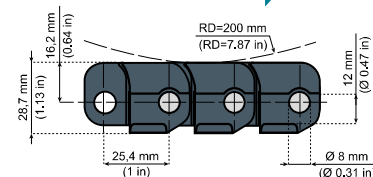

NG® evo conveyor components made from engineered plastic resin

- Longer wearlife than acetal
- Lower friction than acetal
- Good chemical resistance
- High abrasion resistance
- It meets the requirement for materials as stated by EC1935/2004 and FDA CFR21 norms for direct food contact
- Less dust than with acetal chains
- More.....



Applications:

The chainbelt with closed top plates is best suited for conveying glass and PET containers (for example PET bottles with petaloid base).

Pin Material: Martensitic Stainless Steel

2250FT TAB-2251FT TAB
page code:
501110a



Information about this product is only available on our Smart Guide® website.

ITEM DESCRIPTION	MATERIAL	WIDTH L		R MIN.	WEIGHT	
		mm	in		Kg/m	lbs/ft.
LFG2250FT-TAB-K330	LFG Grey	83,8	3,3	500	1,75	1,17
NGE2250FT-TAB-K330	NGE Grey Blue	83,8	3,3	500	1,75	1,17
LFG2250FT-TAB-K450	LFG Grey	114,3	4,5	500	2,04	1,37
NGE2250FT-TAB-K450	NGE Grey Blue	114,3	4,5	500	2,04	1,37
LFG2251FT-TAB-K330	LFG Grey	83,8	3,3	500	1,75	1,17
NGE2251FT-TAB-K330	NGE Grey Blue	83,8	3,3	500	1,75	1,17
LFG2251FT-TAB-K450	LFG Grey	114,3	4,5	500	2,19	1,47
NGE2251FT-TAB-K450	NGE Grey Blue	114,3	4,5	500	2,19	1,47

Standard length: 120 pitches (3,048 m - 10 ft.)

Max load capacity: (LFG-FT): 2000N (450lbs) - (LFG-FG): 1900N (425lbs)

Standard materials

NGE (GREY BLUE)

New Generation®

LFG (GREY)

Low friction acetal resin

materials details:



Chains & sprockets	Wear strips	Side guide brackets & accessories	Levelers	Engineering manual
Modular belts & sprockets	Chain & belt return systems	Frame & structure supports	Bearing supports	
Curves & tracks	Side guide solutions	Miscellaneous products	Equipment	

3 0 7 1 5 a

www.SystemPlastSmartGuide.com

DRIVE AND RETURN SPROCKETS

FOR CHAINBELTS 1" PITCH (25,4 mm)
2250 TAB FT - 2251 M FT - 2251 TAB FT - 2260 M FT - 2260 M FG

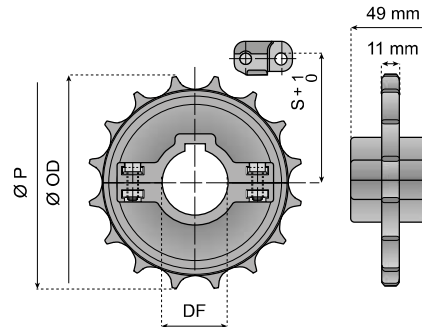

Features:

- Split versions: quick and easy replacement.
- Foolproof design.
- Excellent wear and chemical resistance.
- Recyclable.

MOLDED DRIVE SPROCKETS - SPLIT FIXED			
Z	Ø 30	Ø 35	Ø 40
	ITEM DESCRIPTION		
16	2260-16R30M-DS	2260-16R35M-DS	2260-16R40M-DS
18	2260-18R30M-DS	2260-18R35M-DS	2260-18R40M-DS
19	2260-19R30M-DS	2260-19R35M-DS	2260-19R40M-DS

MOLDED RETURN SPROCKETS - SPLIT			
Z	Ø 30	Ø 35	Ø 40
16	2260-16R30M-RS	2260-16R35M-RS	2260-16R40M-RS
18	2260-18R30M-RS	2260-18R35M-RS	2260-18R40M-RS
19	2260-19R30M-RS	2260-19R35M-RS	2260-19R40M-RS

Z	Ø OD mm	Ø P mm	Ø M mm	S mm
16	130,9	130,2	90	67,8
18	146,8	146,3	110	75,7
19	156,3	154,3	110	80,5

Material: reinforced polyamide (black), screws in stainless steel, nuts in nickel plated brass.



New design

3 0 9 9 0 a

Features:

- Very high strength.
- Split versions: quick and easy replacement.
- Foolproof design.
- Completely closed structure, easy to clean and to disinfect.
- Excellent wear and chemical resistance.
- Recyclable.

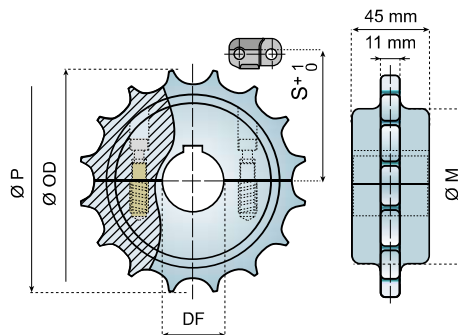

Information about this product is only available on our Smart Guide® website.

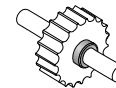

Set collars, go to:
5 4 6 3 0 a



See also the sprockets and idler wheels:

3 0 7 1 5 b

MACHINED DRIVE SPROCKETS - SPLIT FIXED					
Z	Ø 23*	Ø25	Ø 30	Ø 35	Ø 40
	ITEM DESCRIPTION				
16	-	2260-16R25M-DMS	2260-16R30M-DMS	2260-16R35M-DMS	2260-16R40M-DMS
18	-	2260-18R25M-DMS	2260-18R30M-DMS	2260-18R35M-DMS	2260-18R40M-DMS
19	-	2260-19R25M-DMS	2260-19R30M-DMS	2260-19R35M-DMS	2260-19R40M-DMS

MACHINED RETURN SPROCKETS - SPLIT					
Z	Ø 23*	Ø25	Ø 30	Ø 35	Ø 40
16	2260-16R23M-RMS	2260-16R25M-RMS	2260-16R30M-RMS	2260-16R35M-RMS	2260-16R40M-RMS
18	2260-18R23M-RMS	2260-18R25M-RMS	2260-18R30M-RMS	2260-18R35M-RMS	2260-18R40M-RMS
19	2260-19R23M-RMS	2260-19R25M-RMS	2260-19R30M-RMS	2260-19R35M-RMS	2260-19R40M-RMS



See belts with 8,7mm thickness:

3 0 3 0 0 a

See belts with 12,7mm thickness:

3 0 4 1 0 a

Material: polyamide (natural white), screws in stainless steel, bushings in brass. *Plain bore

Chains & sprockets	Wear strips	Side guide brackets & accessories	Levelers	Engineering manual
Modular belts & sprockets	Chain & belt return systems	Frame & structure supports	Bearing supports	
Curves & tracks	Side guide solutions	Miscellaneous products	Equipment	

3 0 9 9 0 a

SPROCKETS WITH BUSHINGS CONCEPT / DETAILS

www.SystemPlastSmartGuide.com

- No rotation of nuts inside plastic.
- Fail safe disassembling.
- Quick and easy replacement.

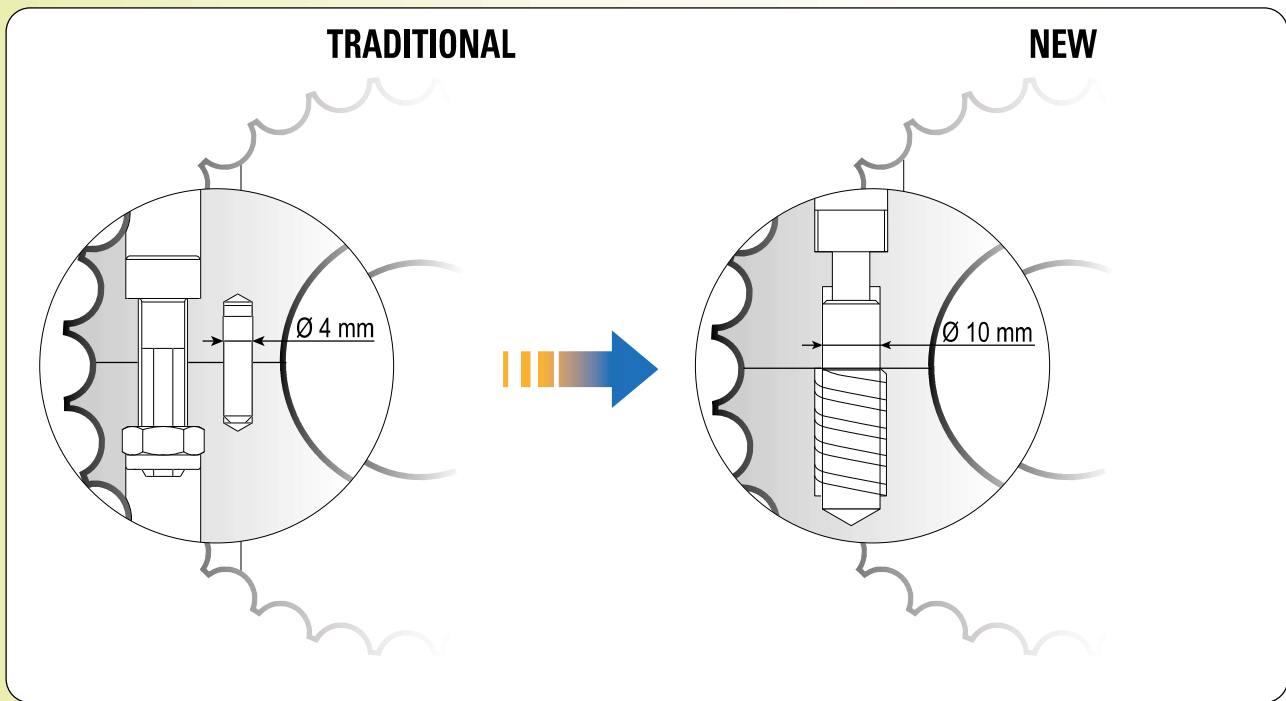

- Reduced number of holes providing.
 - Better hygiene
 - Easier access
 - Less tooth perforation.
- Completely closed structure, easy to clean and to disinfect.

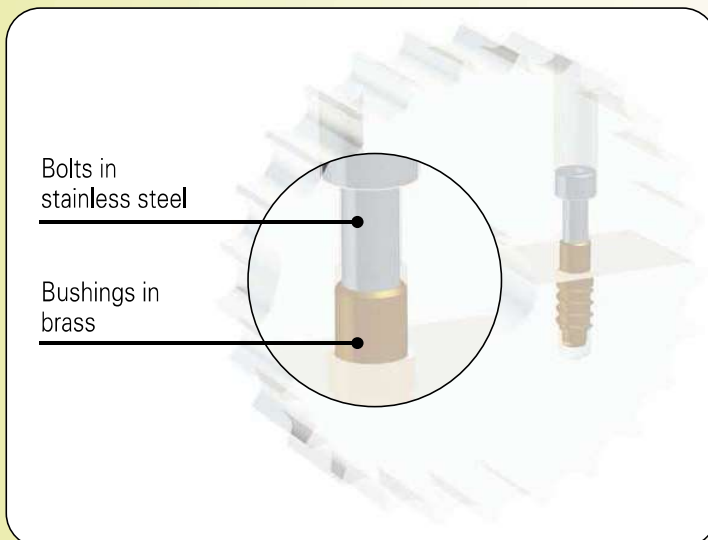

Chains & sprockets	Wear strips	Side guide brackets & accessories	Levelers	Engineering manual
Modular belts & sprockets	Chain & belt return systems	Frame & structure supports	Bearing supports	
Curves & tracks	Side guide solutions	Miscellaneous products	Equipment	

3 0 9 9 5 a

MOLDED SPROCKETS 2120-2250 SNAP CONCEPT / DETAILS

www.SystemPlastSmartGuide.com

New

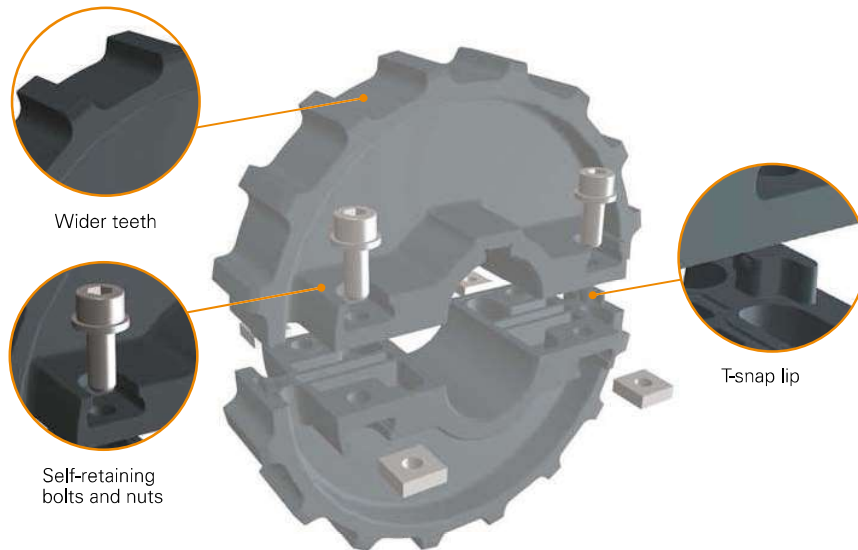

The molded sprockets for our 2120-2250 series plastic modular belts have been improved. In comparison to the previous sprocket design, the new sprockets offer following benefits:

LONGER LIFE

The sprocket teeth have been enlarged by 8% (2250 only) to better transfer the load from sprocket to belt. This will also result in a longer wear life of sprocket and belt. Moreover, a new material is used, which is more stable in all application conditions and offers increased impact resistance.

EASIER USE OF SHAFT COLLARS

Shaft collars can now be used more easily, Hub width has been slightly reduced from 49 mm to 47,5 mm. Now, all our standard shaft collars can be used in combination with these sprockets, even on conveyors with 85 mm center-to-center distance.

SIMPLER INSTALLATION

Bolts and nuts can be inserted in the proper seats with a small interference, designed to avoid losing these parts during assembly/disassembly. There will be no more time lost due to bolts or nuts falling to the floor while installing a sprocket. The new and unique snap-fastening system is another feature that makes sprocket assembly much easier. The T-shaped lip at the edge of the sprocket half, simply snaps into its counterpart in the other half. When put around the shaft, the two halves will stick together even without fixing the bolts and nuts.

IMPROVED STRENGTH AND WEAR LIFE

The design of the rib structure, especially around the hub, has been optimized. This has resulted in improved strength and reduced weight at the same time. The improved roundness results in a smoother belt operation.

NEW SNAP-FASTENING SYSTEM

The new and unique snap-fastening system makes sprocket assembly faster and easier. Besides, the strength has been improved by adding a T-shaped rib and a new design of the hub area.

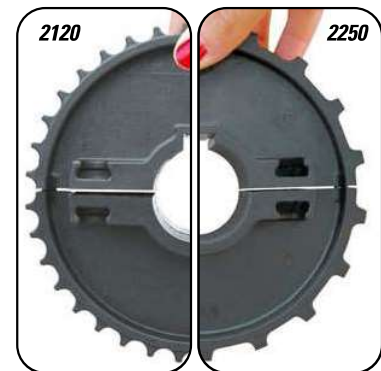

Parts snap together without fixing bolts

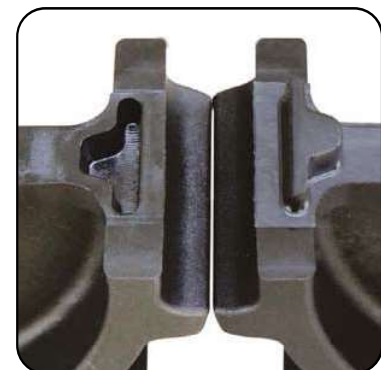

T-snap lip

For drive and return sprockets, go to:

2120 series, go to:

3 0 1 6 0 a
3 0 1 6 0 c

2250 series, go to:

3 0 3 9 5 a
3 0 3 9 5 c

Note:

The new sprockets are completely interchangeable with the previous design. Part numbers and item descriptions are unchanged.

Chains & sprockets	Wear strips	Side guide brackets & accessories	Levelers	Engineering manual
Modular belts & sprockets	Chain & belt return systems	Frame & structure supports	Bearing supports	
Curves & tracks	Side guide solutions	Miscellaneous products	Equipment	



continue ►

7 3 5 1 5 a

PRODUCT HANDLING

GENERAL CALCULATION

CHAIN/BELT PULL CALCULATION FOR GENERAL PURPOSE CONVEYOR

The pull required to convey the products can be calculated for several conveyor types as follow:

A- STRAIGHT FLAT CONVEYOR WITHOUT ACCUMULATION

The total pull at drive end is the sum of return part pull and carry part pull. See below scheme for involved forces representations at conveyor carry and return parts.

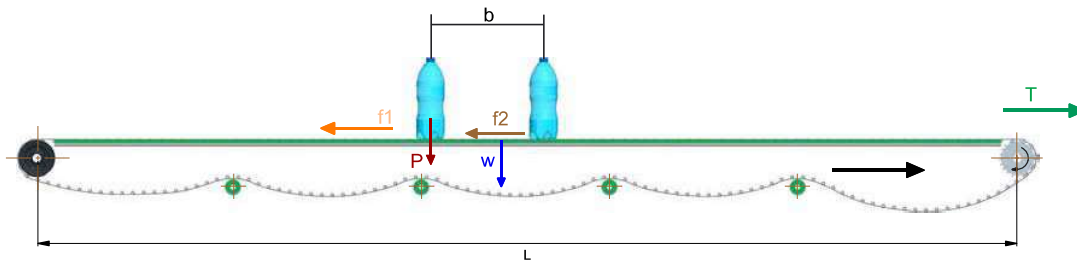

L: Length of the conveyor shaft to shaft (m or ft);

b: Product pitch, not required when product weight per unit length is noted;

P: Product weight per unit length (N/m or lbf/ft);

W: belt/chain weight per unit length (N/m or lbf/ft);

g: gravity (m/s² or ft/s²);

The mass of chain per unit length is provided for each chain on SmartGuide® catalog;

For belt the mass per unit square is available on SmartGuide® catalog; the mass per unit length is done by multiplying the mass per unit square by the width of the belt in [m] or [ft].

CARRY PART:

The carry part pull T_c is the sum of f_1 and f_2 :

(1) $T_c = (f_1 + f_2)$ [N or lbf]

f_1 : friction force between belt/chain and wear strips due to the product weight

f_2 : friction force between belt/chain and wear strips due to belt/chain weight

(2) $f_1 = \mu_{cp} * P * L$

μ_{cp} : coefficient of dynamic friction between product and belt/chain due to product

(3) $f_2 = \mu_{cw} * W * L$

μ_{cw} : coefficient of dynamic friction between belt/chain and wear strip due to belt/chain

Equation (1) becomes:

(4) $T_c = (M * \mu_{cp} + M_c * \mu_{cw}) * g * L$ [N or lbf]

M_c : Mass of chain/belt per unit length [kg/m or lb/ft]

M : Mass of the product per unit length [kg/m or lb/ft]

NOTE: In normal condition we assume the product for not slide over the chain/belt so $\mu_{cp} = \mu_{cw}$.

For other conditions where product slides over the chain/belt as accumulation $\mu_{cp} \neq \mu_{cw}$.

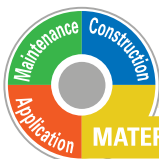

MATERIALS AND CALCULATIONS - General index 7 3 5 1 0 a -

continue ►

7 3 5 1 9 a Product handling maximum acceleration

7 3 5 2 6 a Thermal expansion

7 3 5 4 2 a Bearing selection

7 3 5 2 2 a Pressure of accumulation products

7 3 5 2 8 a 2500RR calculations

7 3 5 4 7 a Bearing and shaft

7 3 5 2 4 a 90° product transfer with belts

7 3 5 3 3 a 2253RTC calculations

7 3 5 7 8 a Coefficient of friction of standard materials



Chains & sprockets	Wear strips	Side guide brackets & accessories	Levelers	Engineering manual
Modular belts & sprockets	Chain & belt return systems	Frame & structure supports	Bearing supports	
Curves & tracks	Side guide solutions	Miscellaneous products	Equipment	



7 3 5 1 6 a

PRODUCT HANDLING

GENERAL CALCULATION

RETURN PART

In the return part there is no product carried, thus the mass of the product per unit length **M=0**.

The return part pull **T_R** is then:

$$(5) T_R = g * L * M_c * \mu_{cr} \text{ [N or lbf]}$$

μ_{cr}: coefficient of dynamic friction between belt/chain and guide in the return part.

The total pull **T** of the flat conveyor (excluded the pull due to chordal effect) is done by:

$$(6) T = T_C + T_R = g * L * (M * \mu_{cp} + M_c (\mu_{cw} + \mu_{cr})) \text{ [N or lbf]}$$

The coefficient of friction can be monitored with the iCOF® device. For more details refer to **5 7 0 8 0 a**

B- STRAIGHT FLAT CONVEYOR WITH ACCUMULATION:

In case of accumulation of the product, the pull will be as in formula (6) added the contribution of accumulation section.

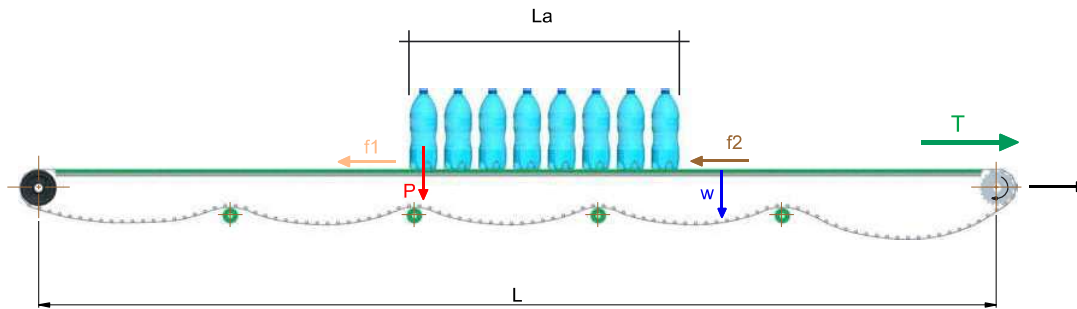

Considering:

L_a: length of the accumulation section [m or ft];

M_a: mass per unit length of accumulated products [kg/m or lb/ft];

μ_{cp}: friction coefficient between belt/chain and accumulated products;

The COFs between chain/belt and wearstrips and between chain/belt and products are available at page **7 3 5 7 8 a**

The Total pull will be:

$$(6a) T = T_C + T_R + T_a = [g * (L - L_a) * (M * \mu_{cp} + M_c * \mu_{cw})] + [g * L * M_c * \mu_{CR}] + [M_a * \mu_{cp} * g * L_a]$$



MATERIALS AND CALCULATIONS - General index 7 3 5 1 0 a -

◀ back continue ▶

7 3 5 1 9 a Product handling maximum acceleration	7 3 5 2 6 a Thermal expansion	7 3 5 4 2 a Bearing selection
7 3 5 2 2 a Pressure of accumulation products	7 3 5 2 8 a 2500RR calculations	7 3 5 4 7 a Bearing and shaft
7 3 5 2 4 a 90° product transfer with belts	7 3 5 3 3 a 2253RTC calculations	7 3 5 7 8 a Coefficient of friction of standard materials



Chains & sprockets	Wear strips	Side guide brackets & accessories	Levelers	Engineering manual
Modular belts & sprockets	Chain & belt return systems	Frame & structure supports	Bearing supports	
Curves & tracks	Side guide solutions	Miscellaneous products	Equipment	

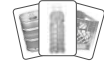

◀ back

7 3 5 1 7 a **PRODUCT HANDLING**
GENERAL CALCULATION

B- STRAIGHT INCLINED CONVEYOR

As the only difference between an inclined and a flat conveyor is the angle of inclination α , we will skip most calculation steps to get in the final formula.

In below inclined conveyor schematic, all significant forces of the conveyor are considered

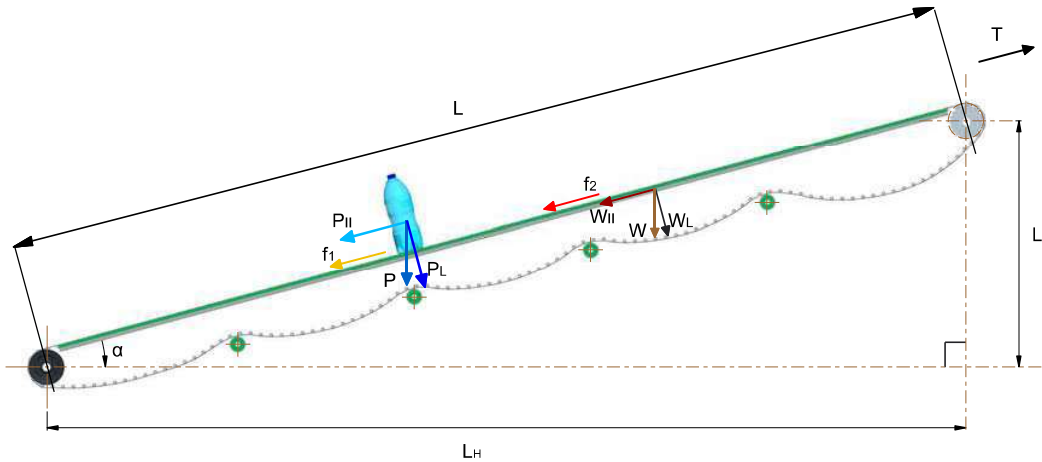

α = incline angle (°);

CARRY PART

The carry part pull T_c is the sum of all horizontal forces;

$$(7) T_c = (f_1 + P_{II} + f_2 + W_{II})$$

where

$$(8) f_1 = \mu_{cp} * P_L * L = \mu_{cp} * P * L * \cos \alpha$$

$$(9) f_2 = \mu_{cw} * W_L * L = \mu_{cw} * W * L * \cos \alpha$$

$$(10) P_{II} = P * L * \sin \alpha = M * g * L * \sin \alpha$$

$$(11) W_{II} = W * L * \sin \alpha = M_c * g * L * \sin \alpha$$

RETURN PART

In the return part there is no product carried, thus $M=0$.

$$(12) T_r = M_c * g * L * (\mu_{cr} * \cos \alpha + \sin \alpha)$$

The total pull T of the inclined/declined conveyor (excluded the pull due to chordal effect) is done by:

$$(13) T = T_c + T_r = g * L * [M * (\mu_{cp} * \cos \alpha + \sin \alpha) + M_c * (\mu_{cw} * \cos \alpha + \sin \alpha)] + g * L * M_c * (\mu_{cr} * \cos \alpha + \sin \alpha)$$

C- NET SHAFT POWER NP

$$(14) NP = T * v$$

V is the conveyor speed [m/s or ft/s]

T the pull [kN or lbf]

NP [kW or lbf*ft/s]

Above calculation is the basic, for detailed calculation use our calculation program SPEC® (<http://spec.systemplast.com>)



◀ back

7 3 5 1 9 a Product handling maximum acceleration

7 3 5 2 6 a Thermal expansion

7 3 5 4 2 a Bearing selection

7 3 5 2 2 a Pressure of accumulation products

7 3 5 2 8 a 2500RR calculations

7 3 5 4 7 a Bearing and shaft

7 3 5 2 4 a 90° product transfer with belts

7 3 5 3 3 a 2253RTC calculations

7 3 5 7 8 a Coefficient of friction of standard materials

Chains & sprockets	Wear strips	Side guide brackets & accessories	Levelers	Engineering manual
Modular belts & sprockets	Chain & belt return systems	Frame & structure supports	Bearing supports	
Curves & tracks	Side guide solutions	Miscellaneous products	Equipment	



continue ►

MAXIMUM ACCELERATION:

The maximum acceleration force F_{max} on a product to be able to convey the product with the chain depends on the friction between product and chain.

Maximum acceleration a_{max} can be calculated with:

$$a_{max} = \frac{F_{max}}{M} = \frac{W * \mu}{M} = \frac{M * g * \mu}{M} = g * \mu$$

W = weight of product in [N] or [Lb_f]

M = weight of product in [kg] or [lb_m]

μ = coefficient of friction between chain/belt and product

g = gravitational acceleration = 9.81 m/s² (32.2 ft/s²)

MAXIMUM FORCE ON PRODUCTS TO AVOID TIPPAGE:

The maximum acceleration a_{CG} without products falling over is dependent on the shape (position of the center of gravity), the weight, and the product material. This is for instance, it is also important when the product is being conveyed onto a dead plate.

When a bottle is moving on conveyors, there are external forces acting on it:

$$F^{ext} = M * a_{CG} = \mu * M * g$$

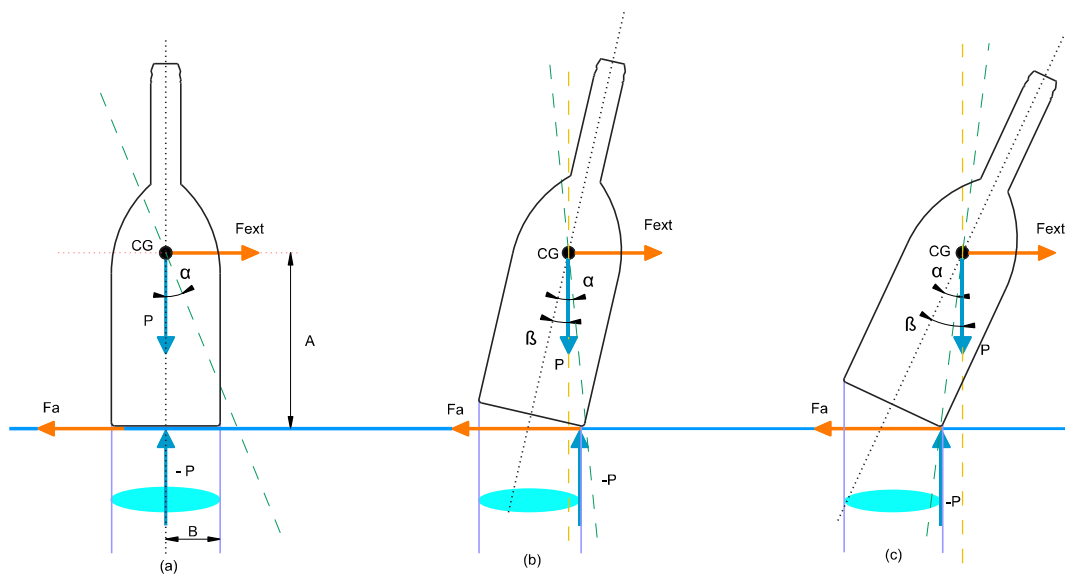

Figure 1

The force F^{ext} is the force due to acceleration or deceleration of the product or due to a different cause like other bottles or a side guide.



continue ►

7 3 5 1 5 a Product handling

7 3 5 2 6 a Thermal expansion

7 3 5 4 2 a Bearing selection

7 3 5 2 2 a Pressure of accumulation products

7 3 5 2 8 a 2500RR calculations

7 3 5 4 7 a Bearing and shaft

7 3 5 2 4 a 90° product transfer with belts

7 3 5 3 3 a 2253RTC calculations

7 3 5 7 8 a Coefficient of friction of standard materials



Chains & sprockets	Wear strips	Side guide brackets & accessories	Levelers	Engineering manual
Modular belts & sprockets	Chain & belt return systems	Frame & structure supports	Bearing supports	
Curves & tracks	Side guide solutions	Miscellaneous products	Equipment	



◀ back

7 3 5 2 0 a **PRODUCT HANDLING**
GENERAL CALCULATION

BOTTLE EQUILIBRIUM:

The equilibrium condition of a bottle is that the vector of the vertical component of resultant forces passing by its gravity center falls inside support base (blue circle) i.e. $\alpha > \beta$. See figure 1.

Angle α is determined by the diameter of the footprint of the product ($B = \frac{1}{2} * \text{bottle diameter}$) and the height of the centre point of gravity (A).

Angle β is determined by the horizontal force on the bottle (F^{ext}) relative to the weight of the bottle (P).

Bottle falls when $\beta > \alpha$. That means in:

$$\frac{F^{ext}}{P} > \frac{B}{A} ; \frac{m * g * \mu}{m * g} > \frac{B}{A} \rightarrow \mu > \frac{B}{A}$$

In conclusion:

when $\mu > \frac{B}{A}$ containers fall; and when $\mu < \frac{B}{A}$ containers remain standing

CENTRIFUGAL FORCES:

When a product is being conveyed through a curve there's a centrifugal force working on the product. This force on the product is compensated by the friction between chain and product and by a side guide.

The centrifugal force is calculated with:

$$F_c = \frac{M * v^2}{r}$$

M = weight of the product

v = speed

r = center radius of the curve

Friction force between chain and product is calculated with:

$$F_m = M * g * \mu$$

g = gravitational acceleration

μ = coefficient of friction between belt/chain and product

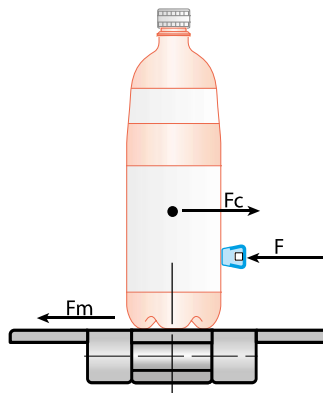

The minimum force **F** that needs to be generated by the side guide is:

$$F = F_c - F_m = M * \left[\frac{v^2}{r} - g * \mu \right]$$



MATERIALS AND CALCULATIONS - General index **7 3 5 1 0 a**

◀ back

7 3 5 1 5 a Product handling

7 3 5 2 6 a Thermal expansion

7 3 5 4 2 a Bearing selection

7 3 5 2 2 a Pressure of accumulation products

7 3 5 2 8 a 2500RR calculations

7 3 5 4 7 a Bearing and shaft

7 3 5 2 4 a 90° product transfer with belts

7 3 5 3 3 a 2253RTC calculations

7 3 5 7 8 a Coefficient of friction of standard materials



Chains & sprockets	Wear strips	Side guide brackets & accessories	Levelers	Engineering manual
Modular belts & sprockets	Chain & belt return systems	Frame & structure supports	Bearing supports	
Curves & tracks	Side guide solutions	Miscellaneous products	Equipment	



7 3 5 2 2 a PRESSURE OF ACCUMULATION PRODUCTS

GENERAL CALCULATION

PRESSURE OF ACCUMULATING PRODUCTS OR BACKLINE PRESSURE:

When a product is standing still (e.g. against a stopper or guide), the chain running underneath the product creates a force on the product equal to the weight of the product multiplied by the coefficient of friction between chain and product.

Each following product is pushing with the same force against the next product, so the resulting force is proportional to the total weight of products upstream. This force is the same of the accumulation contribute on formula 6A.

$$F_a = W_a * L_a * \mu$$

$$F_a = M_a * g * \mu_{cp} * L_a$$

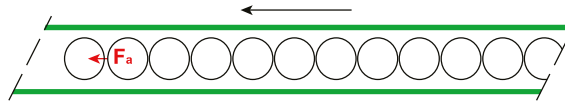

- F_a = accumulation force
- W_a = weight of the accumulating products in Kg/m (or lb/ft).
- L_a = length of accumulation in m (or ft)
- μ = coefficient of friction between chain and product.

SIDE TRANSFER ACTION:

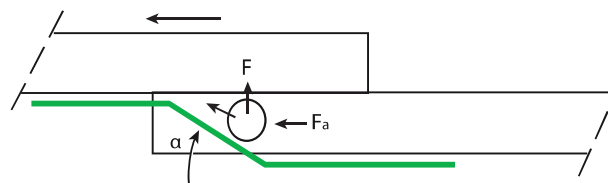

Pushing the product sideward creates a force F on the product against the side guide.

$$F = F_a * \sin(\alpha) = W_a * L_a * \mu * \sin(\alpha)$$

(see explanation of symbols above)

Nowadays, can and bottle wall thickness is becoming thinner and thinner. At the same time, more installations are running with less or no lubrication, thus increasing the coefficient of friction (unless they utilize our NGE / Nolu®-S parts solution). That's why it's important to take also the forces on the products into consideration.

In the above-mentioned formula, the angle α plays an important role in a smooth transfer and reduced forces on the products. This angle should be kept a small as possible. One should also consider the nesting pattern of cans and bottles during a side transfer to optimize guide rail geometry.

CALCULATION OF SIDE GUIDE DISTANCE:

$$\text{SIDE GUIDE DISTANCE } X = D + (N-1) * A$$

Where:

- D = Product diameter
- N = Number of product rows
- A = product-product center distance = $\sqrt{0.75 * D^2}$

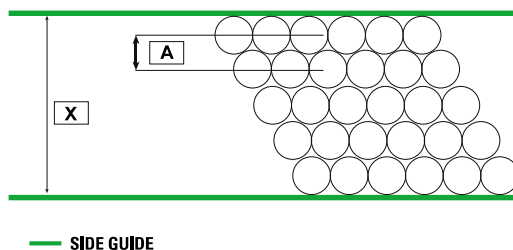

MATERIALS AND CALCULATIONS - General index 7 3 5 1 0 a -

7 3 5 1 5 a Product handling	7 3 5 2 6 a Thermal expansion	7 3 5 4 2 a Bearing selection
7 3 5 1 9 a Product handling maximum acceleration	7 3 5 2 8 a 2500RR calculations	7 3 5 4 7 a Bearing and shaft
7 3 5 2 4 a 90° product transfer with belts	7 3 5 3 3 a 2253RTC calculations	7 3 5 7 8 a Coefficient of friction of standard materials

Chains & sprockets	Wear strips	Side guide brackets & accessories	Levelers	Engineering manual
Modular belts & sprockets	Chain & belt return systems	Frame & structure supports	Bearing supports	
Curves & tracks	Side guide solutions	Miscellaneous products	Equipment	



7 3 5 2 4 a **90° PRODUCT TRANSFER WITH BELTS**
GENERAL CALCULATION

90° PRODUCT TRANSFER:

When transferring products from one conveyor to another at a 90° angle, it's common practice to use full radius guide rails with dead plates which span the space between the infeed and outfeed conveyors. Products moving along the full radius guide rail exert high pressure on the rail and on each other, easily resulting in damage.

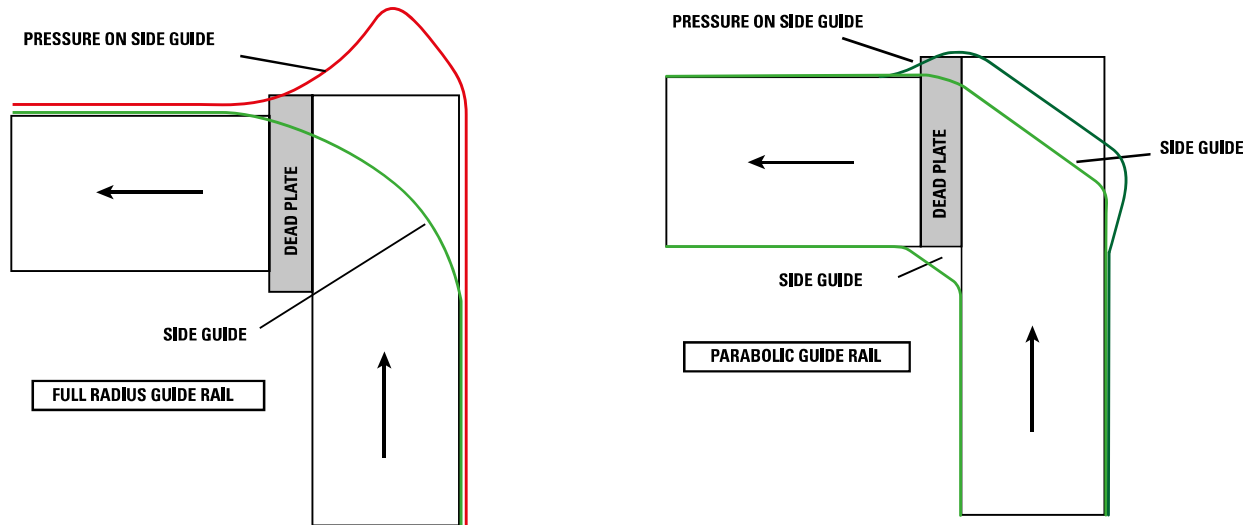

The parabolic guide rail distributes the pressure better along the outer guide rail. This results in significantly less potential for damage on products or deflection of the guide rail. However, on the inside corner of the curve, extra room must be created for an extended dead plate "dead area".

The use of the System Plast® active transfer wing system will eliminate the dead plate and further reduce the pressure on products and side guides.

Belt with transfer wing. Go to:

½"	3	0	0	4	5	a
¾"	3	0	2	1	5	a
1"	3	0	3	2	0	a



MATERIALS AND CALCULATIONS - General index **7 3 5 1 0 a** -

7 3 5 1 5 a Product handling	7 3 5 2 6 a Thermal expansion	7 3 5 4 2 a Bearing selection
7 3 5 1 9 a Product handling maximum acceleration	7 3 5 2 8 a 2500RR calculations	7 3 5 4 7 a Bearing and shaft
7 3 5 2 2 a Pressure of accumulation products	7 3 5 3 3 a 2253RTC calculations	7 3 5 7 8 a Coefficient of friction of standard materials

Chains & sprockets	Wear strips	Side guide brackets & accessories	Levelers	Engineering manual
Modular belts & sprockets	Chain & belt return systems	Frame & structure supports	Bearing supports	
Curves & tracks	Side guide solutions	Miscellaneous products	Equipment	



7 3 5 2 6 a THERMAL EXPANSION GENERAL CALCULATION

THERMAL EXPANSION

Due to temperature variation, the belt width can change according to the delta temperature. The belt width variation is function of the delta temperature and the belt material itself. See below formula for thermal expansion calculation.

CALCULATION:

Expected expansion ΔW [mm or in];

$$\Delta W = W * \Delta T * f$$

W = belt width [m] or [in]

ΔT = temperature difference (Operating temperature - Ambient temperature at manufacturing site) [°C] or [°F]

f = thermal expansion factor (material property) or Linear Thermal Expansion Coefficient [mm/m/°C] or [in/in/°F]

MATERIAL	THERMAL EXPANSION FACTOR F	
	[mm/m/°C]	[in/in/°F]
LF (Acetal)	0.12	6.66E-5
NG®evo conveyor components made from engineered plastic resin (PBT)	0.13	7.22E-5
PP (Polypropylene)	0.15	8.33E-5
HT (PA)	0.08	4.44E-5
XT (PPS)	0.26	1.44E-4

To be able to absorb the thermal expansion the belt needs some clearance on the side. Depending on the expected temperature difference the structure should be wide enough to make sure the belt will not get stuck at high temperatures or, in case of low temperatures, be small enough to still support the belt at low temperatures.

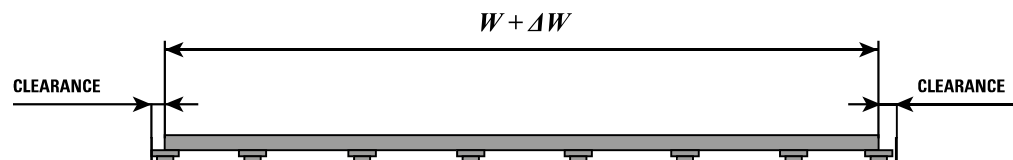

The total clearance per side to be considered is (indicative values):

BELT NOMINAL WIDTH		TOTAL CLEARANCE (*)	
$W < 500$ mm	$W < 20''$	4 mm	0.16''
$500 < W < 1500$ [mm]	$20'' < W < 60''$	6 mm	0.24 ''
$1500 < W < 3000$ [mm]	$60'' < W < 120''$	8 mm	0.32''
$W > 3000$ mm	$W > 120''$	10 mm	0.39''

(*) For PP belts, please consider the extra dimension due to material expansion during molding process in the clearance calculations.

NOMINAL WIDTH TOLERANCE

The standard tolerance on the nominal width of belts/chains made in Acetal (LF) or Polybutylene terephthalate (NGE) is **+0 / - 0.5 %**.

The standard tolerance on the nominal width of belts/chains made in Polypropylene (PP, PP-FR-EC, CR) is **+1 % / +2 %**.

The standard tolerance on the nominal width of belts/chains made in Acetal (POM-AS) is **0 / +0.6 %**.



MATERIALS AND CALCULATIONS - General index 7 3 5 1 0 a -

7 3 5 1 5 a Product handling

7 3 5 2 4 a 90° product transfer with belts

7 3 5 4 2 a Bearing selection

7 3 5 1 9 a Product handling maximum acceleration

7 3 5 2 8 a 2500RR calculations

7 3 5 4 7 a Bearing and shaft

7 3 5 2 2 a Pressure of accumulation products

7 3 5 3 3 a 2253RTC calculations

7 3 5 7 8 a Coefficient of friction of standard materials

Chains & sprockets	Wear strips	Side guide brackets & accessories	Levelers	Engineering manual
Modular belts & sprockets	Chain & belt return systems	Frame & structure supports	Bearing supports	
Curves & tracks	Side guide solutions	Miscellaneous products	Equipment	



continue ►

CONSIDERATION OF THERMAL INFLUENCES

1. Calculate the thermal width expansion "ΔIW"
2. Calculate the thermal belt elongation "ΔIE"
3. Determine the catenary height "H"

NOTE: THESE CONSIDERATIONS ARE NOT INCLUDING THE EXPANSION INFLUENCES DUE TO BELT TENSION!

2500RR
Construction details.
Go to:

7 2 3 1 0 a

Thermal expansion calculation:

Calculation: Expected expansion [mm] $\Delta I = W \cdot \Delta T \cdot f$

f = thermal expansion factor (of PPG: ~ 0,15 mm/m/°C or 8,33E-5 in/in/°F)

W = belt width [mm]/1000 or belt length per zone [mm]/1000

ΔT = temperature difference = (°C) - 21°C

1. Calculate the thermal width expansion "ΔIW"

Example for a belt 105" (2667 mm) width, at 80°C

$\Delta I = W \cdot \Delta T \cdot f$

$\Delta I = 2667 \text{ mm}/1000 \times (80^\circ - 21^\circ)\text{C} \times 0,15 \text{ mm}/\text{m}/^\circ\text{C}$

$\Delta IW = 23 \text{ mm}$

Thermal width expansion can also be read out of below diagram.

Belt side expansion [mm]

THERMAL EXPANSION OF PPG 2500RR BELT

Belt width

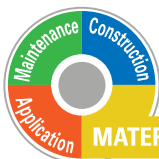
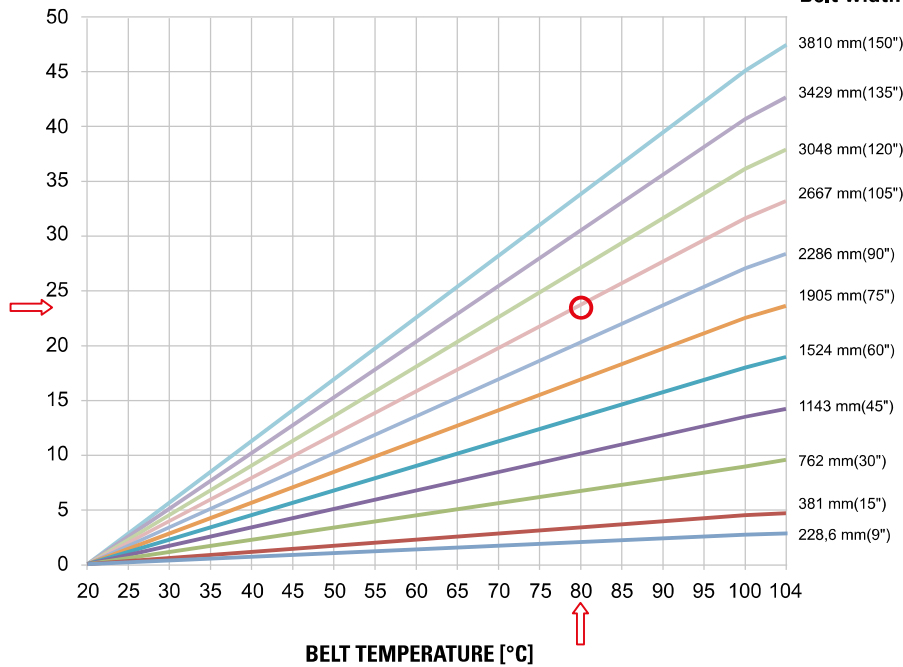

continue ►

7 3 5 1 5 a Product handling

7 3 5 2 4 a 90° product transfer with belts

7 3 5 4 2 a Bearing selection

7 3 5 1 9 a Product handling maximum acceleration

7 3 5 2 6 a Thermal expansion

7 3 5 4 7 a Bearing and shaft

7 3 5 2 2 a Pressure of accumulation products

7 3 5 3 3 a 2253RTC calculations

7 3 5 7 8 a Coefficient of friction of standard materials



Chains & sprockets	Wear strips	Side guide brackets & accessories	Levelers	Engineering manual
Modular belts & sprockets	Chain & belt return systems	Frame & structure supports	Bearing supports	
Curves & tracks	Side guide solutions	Miscellaneous products	Equipment	

7 3 5 2 9 a

2500RR CALCULATIONS

RAISED RIB BELT 2500



2. Calculate the thermal belt elongation "ΔIE" for e.g. different temperature zones in a warmer tunnel

Example for a warmer-tunnel, with a 175 m shaft-distance, standard conveyor design with head drive, and three temperature zones.

Zone 1 : 5 m long, 40°C

Zone 2 : 7,5 m long, 80°C

Zone 3 : 5 m long, 50°C

Note: Don't forget to count also the amount of belt of the return part, where the belt is also exposed to the several temperatures! This leads to double the elongation of the belt in each zone!

◀ back continue ▶

2500RR
Construction details.
Go to:

7 2 3 1 0 a

$\Delta IE = \Delta I_{Zone1} + \Delta I_{Zone2} + \Delta I_{Zone3}$

$\Delta I_{Zone1} = W_{Zone1} \cdot \Delta T_{Zone1} \cdot f = 5 \text{ m} \times (40 - 21)^\circ\text{C} \times 0,15 \text{ mm/m}^\circ\text{C} = 14,3 \text{ mm} \times 2 = 28,6 \text{ mm}$

$\Delta I_{Zone2} = W_{Zone2} \cdot \Delta T_{Zone2} \cdot f = 7,5 \text{ m} \times (80 - 21)^\circ\text{C} \times 0,15 \text{ mm/m}^\circ\text{C} = 66,4 \text{ mm} \times 2 = 132,8 \text{ mm}$

$\Delta I_{Zone3} = W_{Zone3} \cdot \Delta T_{Zone3} \cdot f = 5 \text{ m} \times (50 - 21)^\circ\text{C} \times 0,15 \text{ mm/m}^\circ\text{C} = 21,8 \text{ mm} \times 2 = 43,6 \text{ mm}$

$\Delta IE = 28,6 \text{ mm} + 132,8 \text{ mm} + 43,6 \text{ mm}$

$\Delta IE = 205 \text{ mm}$

Thermal belt elongation can also be read out of below diagram.

THERMAL ELONGATION OF PPG 2500RR BELT

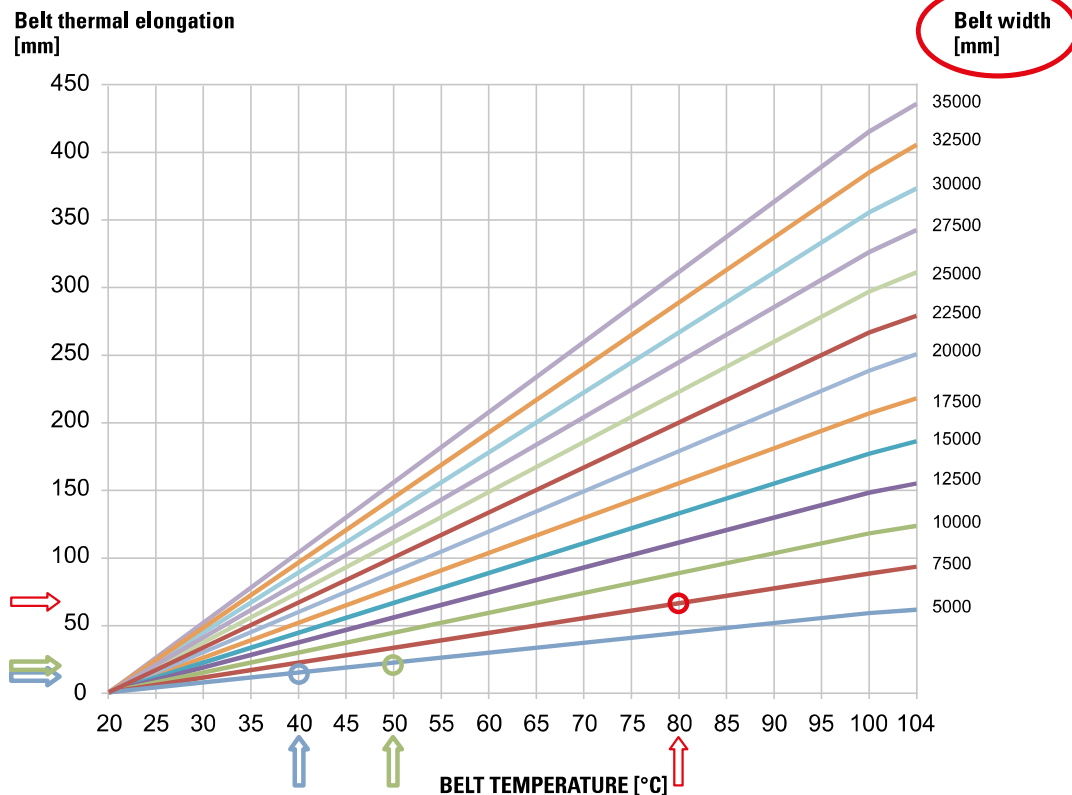

MATERIALS AND CALCULATIONS - General index **7 3 5 1 0 a**

◀ back continue ▶

7 3 5 1 5 a Product handling

7 3 5 2 4 a 90° product transfer with belts

7 3 5 4 2 a Bearing selection

7 3 5 1 9 a Product handling maximum acceleration

7 3 5 2 6 a Thermal expansion

7 3 5 4 7 a Bearing and shaft

7 3 5 2 2 a Pressure of accumulation products

7 3 5 3 3 a 2253RTC calculations

7 3 5 7 8 a Coefficient of friction of standard materials

Chains & sprockets	Wear strips	Side guide brackets & accessories	Levelers	Engineering manual
Modular belts & sprockets	Chain & belt return systems	Frame & structure supports	Bearing supports	
Curves & tracks	Side guide solutions	Miscellaneous products	Equipment	

7 3 5 3 0 a **2500RR CALCULATIONS**

RAISED RIB BELT 2500

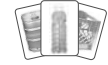

3. Determine the catenary height "H"

Example based on a belt elongation of $\Delta IE = 205$ mm, from thermal belt elongation example go to page code: **7 3 5 2 9 a**
determined by calculation or by using the diagram for thermal elongation go to page code: **7 3 5 2 9 a**)

◀ back continue ▶

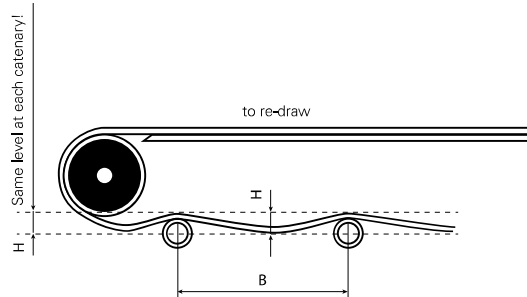

2500RR
Construction details.
Go to:
7 2 3 1 0 a

H = B x h/b

B = expected catenary length / distance between return roller (read out of drawing from the conveyor)

h/b = factor determined from the following diagram

bs = belt stretch (thermal elongation ΔIE from thermal belt elongation example go to page code: **7 3 5 2 9 a**)

Determined by calculation or by using the diagram for thermal elongation go to page code: **7 3 5 2 9 a**

catenary height as a function of belt stretch for all catenary lengths and as long as belt stretch is smaller than the catenary length

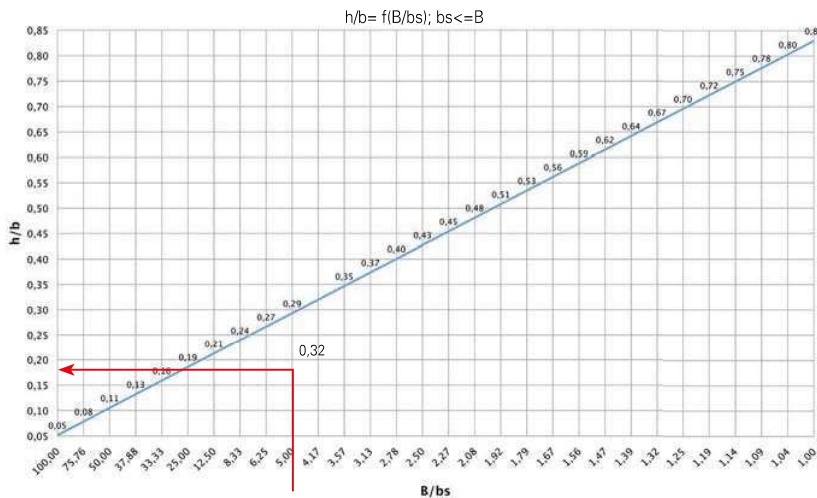

Example:

bs = $\Delta IE = 205$ mm

B = 1000 mm

B/bs = 1000 mm / 205 mm = 4,88 \approx 5

h/b = 0,29 (read out of diagram)

H = B x h/b = 1000 mm x 0,29 = 290 mm

Note: Consider a minimum tolerance of +/-30 mm for the calculated catenary height

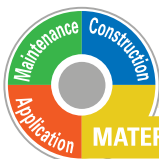

MATERIALS AND CALCULATIONS - General index **7 3 5 1 0 a** -

◀ back continue ▶

7 3 5 1 5 a Product handling

7 3 5 2 4 a 90° product transfer with belts

7 3 5 4 2 a Bearing selection

7 3 5 1 9 a Product handling maximum acceleration

7 3 5 2 6 a Thermal expansion

7 3 5 4 7 a Bearing and shaft

7 3 5 2 2 a Pressure of accumulation products

7 3 5 3 3 a 2253RTC calculations

7 3 5 7 8 a Coefficient of friction of standard materials

Chains & sprockets	Wear strips	Side guide brackets & accessories	Levelers	Engineering manual
Modular belts & sprockets	Chain & belt return systems	Frame & structure supports	Bearing supports	
Curves & tracks	Side guide solutions	Miscellaneous products	Equipment	



◀ back

2500RR
Construction details.
Go to:

7 2 3 1 0 a

7 3 5 3 1 a 2500RR LOAD CAPACITY DEPENDING ON APPLICATION TEMPERATURE

RAISED RIB BELT 2500

LOAD CAPACITY / TEMPERATURE GRAPH

NOTE: Mechanical properties of plastic materials degrade with the increasing temperature.
The following graph indicates the remaining load capacity (%) as a function of the temperature.

LOAD CAPACITY AS A FUNCTION OF THE TEMPERATURE

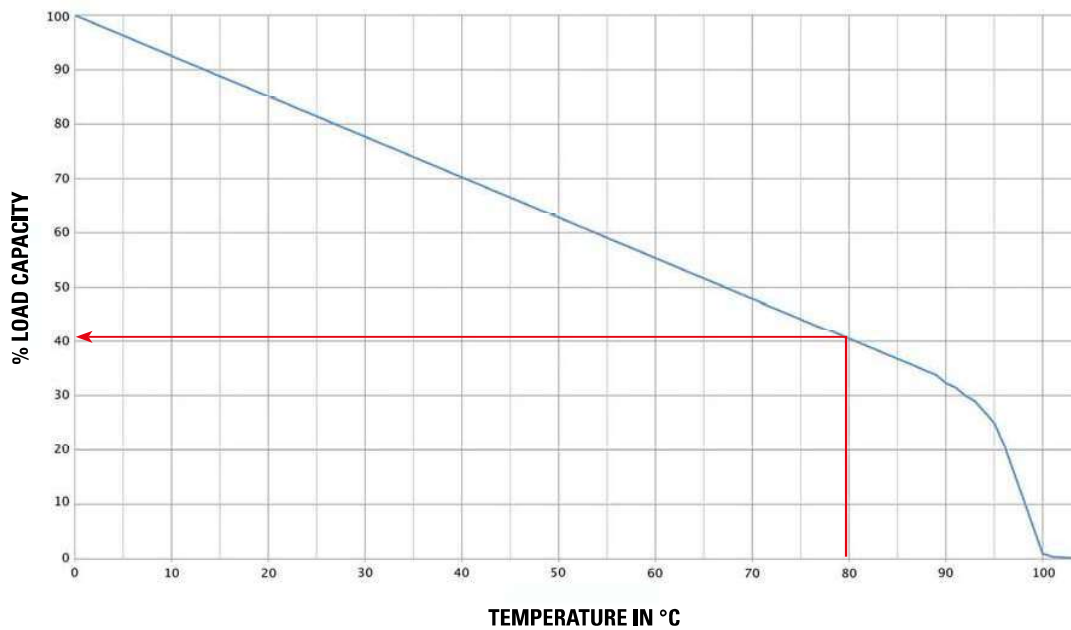

EXAMPLE:

Identify the hottest section. (In the example before: section 2, 80° C)

The allowable max. load capacity/working load of the belt in that particular section is:

Factor 0,41 (read 41% out of diagram) x 30000 N/m = 12300 N/m.

It can happen that the middle section of a machine is more critical with respect to belt load than the drive section, due to the fact that the temperature at the drive is lower and therefore the allowable belt tension is higher.

This needs to be checked carefully.



MATERIALS AND CALCULATIONS - General index 7 3 5 1 0 a -

◀ back

7 3 5 1 5 a Product handling

7 3 5 2 4 a 90° product transfer with belts

7 3 5 4 2 a Bearing selection

7 3 5 1 9 a Product handling maximum acceleration

7 3 5 2 6 a Thermal expansion

7 3 5 4 7 a Bearing and shaft

7 3 5 2 2 a Pressure of accumulation products

7 3 5 3 3 a 2253RTC calculations

7 3 5 7 8 a Coefficient of friction of standard materials

Chains & sprockets	Wear strips	Side guide brackets & accessories	Levelers	Engineering manual
Modular belts & sprockets	Chain & belt return systems	Frame & structure supports	Bearing supports	
Curves & tracks	Side guide solutions	Miscellaneous products	Equipment	

7 3 5 3 3 a

2253RTC CALCULATIONS

2253 ROLLER TOP BELT



continue ►

2253RTC

Construction details.

Go to:

7 2 2 9 0 a

2253RTC

Applications.

Go to:

7 2 6 2 5 a

1- LATERAL MOVEMENT

Auxiliary drive units underneath the belt, running at right angles to the direction of belt travel, enable lateral transfers (left- or right side sorting) of conveyed goods. It can also be used to position a product, for example in front of a palletizer. Since no push-off devices, etc., are necessary (more safe), this approach works to prevent jamming, and allows for compact, space-saving layouts and no safety guards are required.

EXAMPLE HOW TO MAKE A LATERAL MOVEMENT ON THE FLY (*)

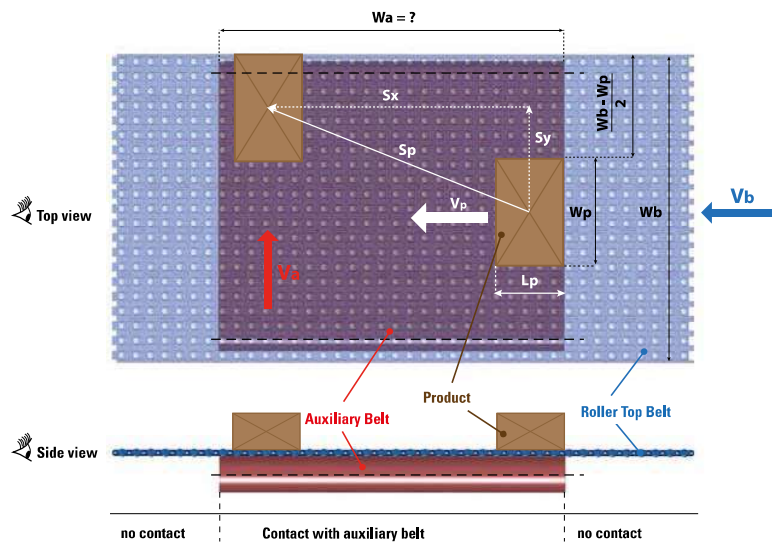

GIVEN DATA:

Width of pack (W_p) = 240 mm;

Length of pack (L_p) = 360 mm

Capacity (P_n) = 30 p/min.

S_{out} = 150 mm

As a rule of thumbs, for a side shift with only one auxiliary belt, the minimum width of the auxiliary belt (1) should be at least 1,5 times the transversal dimension of the pack L_p .

Bigger widths help in leaving more time to the movement thus reducing the speed of the auxiliary belt and consequently giving a better positioning of the pack (inertia results lower).

Minimum Width of the auxiliary belt (1) (W_a) will be calculated as follow:

$$W_a = 1,5 \times 360 \text{ mm} = 540 \text{ mm} \approx 600 \text{ mm.}$$

At the same time minimum pitch in feeding, centre to centre pack, needs to be equal or bigger than the auxiliary belt width to avoid packs to be rotated before being shifted. The minimum pitch will be equal to 600 mm.

(*) For stop and go motion the minimum width of the auxiliary belt W_a is equal to the product length L_p ($W_a = L_p$).

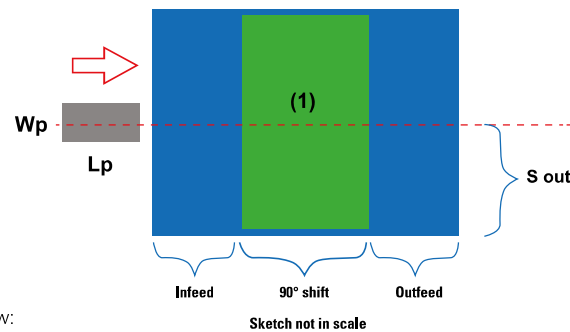

1 m = 3,28 ft



MATERIALS AND CALCULATIONS - General index 7 3 5 1 0 a -

continue ►

7 3 5 1 5 a Product handling

7 3 5 2 4 a 90° product transfer with belts

7 3 5 4 2 a Bearing selection

7 3 5 1 9 a Product handling maximum acceleration

7 3 5 2 6 a Thermal expansion

7 3 5 4 7 a Bearing and shaft

7 3 5 2 2 a Pressure of accumulation products

7 3 5 2 8 a 2500RR calculations

7 3 5 7 8 a Coefficient of friction of standard materials

Chains & sprockets	Wear strips	Side guide brackets & accessories	Levelers	Engineering manual
Modular belts & sprockets	Chain & belt return systems	Frame & structure supports	Bearing supports	
Curves & tracks	Side guide solutions	Miscellaneous products	Equipment	

7 3 5 3 4 a 2253RTC CALCULATIONS

2253 ROLLER TOP BELT

This pitch must be realized, by means of appropriate feeding/metering conveyors (for instance equipped with VG belts) before the packs climb on the roller top belt or on the infeed static of the roller top belt.

Bigger pitches have the effect to increase the speed of the RollerTop system but not the overall dimension of the application.



◀ back continue ▶

- Pack speed V_p :

$$V_p = \frac{\text{Pitch}}{1000} * P_r = 0.6 * 30 = 18 \text{ m/min}$$

- The speed of 2253RTC belt (V_{rt}) can be calculated considering the 2253 RollerTop belt itself running fully on spheres:

$$V_{rt} = \frac{1}{2} * V_p = 0.5 * 18 = 9 \text{ m/min}$$

- Time for the pack to climb on the area (1) (t_c)

$$t_c = \frac{\text{length of pack } L_p \text{ [mm]}}{\text{pack speed } V_p \left[\frac{\text{m}}{\text{min}} \right]} = \frac{360 * 60}{18 * 1000} = 1.2 \text{ s}$$

- Time to cross the auxiliary belt area (1) (t_a)

$$t_a = \frac{\text{overall length shift area [mm]}}{\text{pack speed } V_p \left[\frac{\text{m}}{\text{min}} \right]} = \frac{600 * 60}{18 * 1000} = 2 \text{ s}$$

Once the pack is fully on the area (1) the shift can start.



If the shift is earlier activated, the pack will be turned/misaligned instead of being shifted.

Note: In case the auxiliary belt is running continuously, the dimensions of the auxiliary belt area as well as the overall footprint can be reduced. In such case a more defined and precise controls of the belts timings are required.

- The time available for the side shift (t_s) is given by the difference of the time t_a and t_c

$$t_s = t_a - t_c = 2 - 1.2 = 0.8 \text{ s}$$

The pack is supposed to come on the Roller Top area about in the middle of it.

Consequently, the total travel distance to lead the outer front of the pack completely on the bay area is the sum of S_{out} + half of product width W_p .

- Considering this, the auxiliary belt speed V_a results:

$$V_a = \frac{S_{out} + \frac{W_p}{2} \text{ [mm]}}{t_s \text{ [s]}} = \frac{150 + 120}{0.8 * 1000} = 0.34 \text{ m/s} = 21 \text{ m/min}$$

The infeed is needed to have a stable pack before the shift (head to tail passage can affect the stability of the pack). It should be at least as big as the pack length.

Infeed = $L_p = 360 \text{ mm} \approx 400 \text{ mm}$;

The outfeed is recommendable but not mandatory. The outfeed dimensions should be in the same dimension range of the infeed.

Outfeed = Infeed = 400 mm

The overall footprint or length of the roller top and auxiliary conveyor system will be the sum of infeed, outfeed and shift area length.

Overall footprint = $(400 + 600 + 400) \text{ mm} = 1400 \text{ mm}$.

1 m	= 3.28 ft
1 m/min	= 3.28 ft/min
1 m/s	= 3.28 ft/s

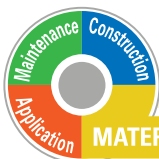

MATERIALS AND CALCULATIONS - General index 7 3 5 1 0 a -

◀ back continue ▶

7 3 5 1 5 a Product handling

7 3 5 2 4 a 90° product transfer with belts

7 3 5 4 2 a Bearing selection

7 3 5 1 9 a Product handling maximum acceleration

7 3 5 2 6 a Thermal expansion

7 3 5 4 7 a Bearing and shaft

7 3 5 2 2 a Pressure of accumulation products

7 3 5 2 8 a 2500RR calculations

7 3 5 7 8 a Coefficient of friction of standard materials

Chains & sprockets	Wear strips	Side guide brackets & accessories	Levelers	Engineering manual
Modular belts & sprockets	Chain & belt return systems	Frame & structure supports	Bearing supports	
Curves & tracks	Side guide solutions	Miscellaneous products	Equipment	

7 3 5 3 5 a 2253RTC CALCULATIONS

2253 ROLLER TOP BELT



2- ROTATION WITH PRODUCT STOPPED: TURNING DISC UNDERNEATH THE 2253RTC BELT

The main advantage of this configuration is the easier handling of the packs in terms of settings of drives required. On the other hand it's need of a fairly exact displacement of the pack in the centre of the table area for a good rotation.

◀ back continue ▶

EXAMPLE OF HOW TO DIMENSION AN APPLICATION OF ROTATION WITH PRODUCT STOPPED:

GIVEN DATA:

- Width of pack (W_p) = 240 mm;
- Length of pack (L_p) = 360 mm
- Capacity (P_r) = 30 p/min.
- Rotation angle (α) = 90°

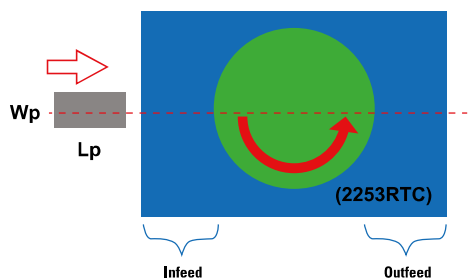

2253RTC
Construction details.
Go to:
7 2 2 9 0 a

2253RTC
Applications.
Go to:
7 2 6 2 5 a

For a proper rotation, the diameter of the disk (D_{TD}) should be in the same range of the dimension of diagonal of the pack. Slightly bigger disks help in reducing the need of a precise placing in the centre of it. In case of big diagonal dimension, if possible, reduce the dimension of the disk to not expose ball placed on the outer diameter to too quick accelerations. Movement would result longer since less balls in contact.

• Disk diameter can be calculated as follow:

$$D_{TD} = \sqrt{W_p^2 + L_p^2} = \left(\sqrt{240^2 + 360^2} \right) \text{ mm} = 432 \text{ mm} \approx 450 \text{ mm}$$

At the same time minimum pitch in feeding, centre to centre pack, needs to be equal or bigger than the turning disk diameter. This to avoid the pack to be rotated when the previous pack is still on the turning disk area. The minimum pitch will be equal to 450 mm.

This pitch must be realized, by means of appropriate feeding/metering conveyors (for instance equipped with VG belts) before the products climb on the 2253RTC or on the infeed static of the roller top belt.



Bigger pitches have the effect to increase the speed of the Roller Top system but not the overall dimension of the application.

• The product speed V_p will be as follow:

$$V_p = \frac{\text{Pitch}}{1000} * P_r = 0.45 * 30 = 14 \text{ m/min}$$

• The speed of 2253RTC belt (VRT) can be calculated considering the 2253 Roller Top belt itself running fully on spheres:

$$V_{\pi} = \frac{1}{2} * V_p = 0.5 * 14 = 7 \text{ m/min}$$

1 m	= 3.28 ft
1 m/min	= 3.28 ft/min
1 m/s	= 3.28 ft/s



MATERIALS AND CALCULATIONS - General index 7 3 5 1 0 a -

◀ back continue ▶

7 3 5 1 5 a Product handling

7 3 5 2 4 a 90° product transfer with belts

7 3 5 4 2 a Bearing selection

7 3 5 1 9 a Product handling maximum acceleration

7 3 5 2 6 a Thermal expansion

7 3 5 4 7 a Bearing and shaft

7 3 5 2 2 a Pressure of accumulation products

7 3 5 2 8 a 2500RR calculations

7 3 5 7 8 a Coefficient of friction of standard materials



Chains & sprockets	Wear strips	Side guide brackets & accessories	Levelers	Engineering manual
Modular belts & sprockets	Chain & belt return systems	Frame & structure supports	Bearing supports	
Curves & tracks	Side guide solutions	Miscellaneous products	Equipment	

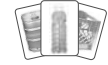

The time available for the rotation (tr) will be as follow:

$$t_r = \frac{\text{Pitch}}{1000 * V_p} = \frac{450}{1000} * \frac{60}{14} = 1.93 \text{ s}$$

◀ back continue ▶

The angular speed ω can be calculated through below formula:

$$\alpha = \omega * t_r$$

$$\text{So } \omega = \frac{\alpha}{t_r} = \frac{\pi}{2 * 1.93} = 0.81 \text{ rad/s} = 49 \text{ rad/min}$$

2253RTC
Construction details.
Go to:
7 2 2 9 0 a

2253RTC
Applications.
Go to:
7 2 6 2 5 a



Note: in this configuration, the conveyor must be stopped while the pack is rotating, and the pack should be as close as possible to the centre of the disk.

The infeed is recommended but not mandatory to have a stable product on conveyor before the rotation.

The infeed length should be at least as big as the pack: 360 mm ≈ 400 mm

The outfeed is recommended too but not mandatory.

The outfeed length should be in the same dimension range of the dimension of the pack once rotated (i.e Wp): 240 mm ≈ 250 mm

The overall footprint or length of the roller top and turning disk system will be the sum of infeed, outfeed and rotation area diameter.

Overall footprint = (400 + 450 + 250) mm = 1100 mm.

Alternately, by placing a roller guide (in yellow) as shown in the sketch below is possible to keep the disk always in motion avoiding the stop of the conveyor during rotation.

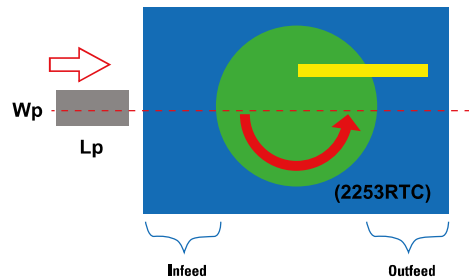

◀ back continue ▶

7 3 5 1 5 a Product handling

7 3 5 2 4 a 90° product transfer with belts

7 3 5 4 2 a Bearing selection

7 3 5 1 9 a Product handling maximum acceleration

7 3 5 2 6 a Thermal expansion

7 3 5 4 7 a Bearing and shaft

7 3 5 2 2 a Pressure of accumulation products

7 3 5 2 8 a 2500RR calculations

7 3 5 7 8 a Coefficient of friction of standard materials



Chains & sprockets	Wear strips	Side guide brackets & accessories	Levelers	Engineering manual
Modular belts & sprockets	Chain & belt return systems	Frame & structure supports	Bearing supports	
Curves & tracks	Side guide solutions	Miscellaneous products	Equipment	

7 3 5 3 7 a 2253RTC CALCULATIONS

2253 ROLLER TOP BELT



3- ROTATION WITH PRODUCT MOVING: AUXILIARY BELTS UNDERNEATH THE 2253RTC BELT

With two parallel auxiliary belts running underneath the 2253RTC belts at different directions, the packs positioned in between the auxiliary belts will rotate while moving on the 2253RTC belt.

◀ back continue ▶

EXAMPLE OF HOW TO DIMENSION AN APPLICATION OF ROTATION WITH PACK MOVING:

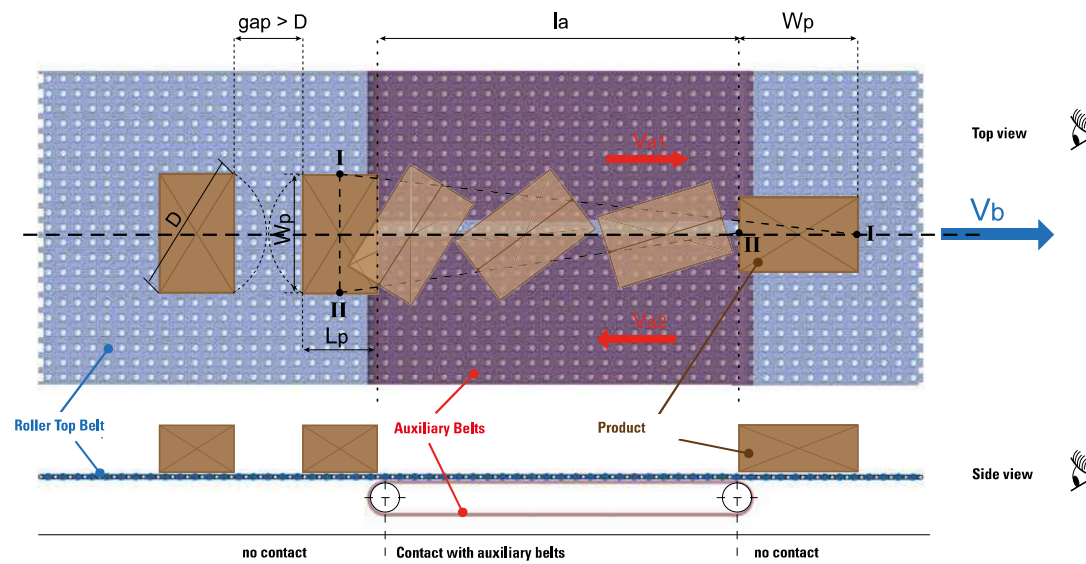

2253RTC Construction details. Go to: **7 2 2 9 0 a**

2253RTC Applications. Go to: **7 2 6 2 5 a**

Width of pack (W_p) = 240 mm;
 Length of pack (L_p) = 360 mm
 Capacity (P_n) = 30 p/min.
 Rotation angle (α) = 90°

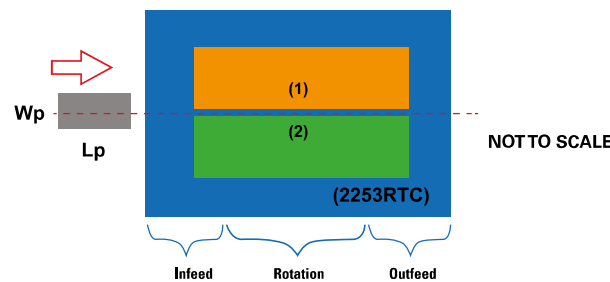

The minimum product pitch, centre to centre pack, needs to be equal or bigger than the product diagonal (D) in order to avoid product touching each other during the rotation.

- The minimum pitch will be equal to

$$\text{Pitch} = D = \sqrt{W_p^2 + L_p^2} = \left(\sqrt{240^2 + 360^2} \right) \text{ mm} = 432 \text{ mm} \approx 450 \text{ mm}$$

This dimension is also corresponding to the minimum product pitch in feeding, centre to centre pack. This pitch must be realized, by means of appropriate feeding/metering conveyors (for instance equipped with VG belts) before the packs climb on the 2253RTC or on the infeed static of the roller top belt.



1 m = 3.28 ft

MATERIALS AND CALCULATIONS - General index 7 3 5 1 0 a -

◀ back continue ▶

7 3 5 1 5 a Product handling

7 3 5 2 4 a 90° product transfer with belts

7 3 5 4 2 a Bearing selection

7 3 5 1 9 a Product handling maximum acceleration

7 3 5 2 6 a Thermal expansion

7 3 5 4 7 a Bearing and shaft

7 3 5 2 2 a Pressure of accumulation products

7 3 5 2 8 a 2500RR calculations

7 3 5 7 8 a Coefficient of friction of standard materials

Chains & sprockets	Wear strips	Side guide brackets & accessories	Levelers	Engineering manual
Modular belts & sprockets	Chain & belt return systems	Frame & structure supports	Bearing supports	
Curves & tracks	Side guide solutions	Miscellaneous products	Equipment	

7 3 5 3 8 a **2253RTC CALCULATIONS**

2253 ROLLER TOP BELT



Bigger pitches have the effect to increase the speed of the RollerTop system but not the overall dimension of the application.

◀ back continue ▶

- The pack speed V_p will be as follow:

$$V_p = \frac{\text{Pitch}}{1000} * P_r = 0.45 * 30 = 14 \text{ m/min}$$

- The speed of 2253RTC belt (V_{RT}) can be calculated considering the 2253 RollerTop belt itself running fully on spheres:

$$V_{RT} = \frac{1}{2} * V_p = 0.5 * 14 = 7 \text{ m/min}$$

It is recommended to keep the length of auxiliary belts (1) e (2) at least equal 1,5 times the diagonal (D) of the product. So, the minimum length of auxiliary belts (1) and (2) will be:

$$L_a = 1.5 * D = 1.5 * 450 \text{ mm} = 675 \text{ mm} \approx 700 \text{ mm}$$

The time to cross (t_a) the auxiliary belt area (1) and (2) will be as follow:

$$t_a = \frac{\text{overall length shift area } L_a [\text{mm}]}{\text{pack speed } V_p [\frac{\text{m}}{\text{min}}]} = \frac{700}{1000} * \frac{60}{18} = 2.33 \text{ s}$$

Considering V_1 and V_2 the speeds given to the spheres by the auxiliary belts (1) and (2) underneath.

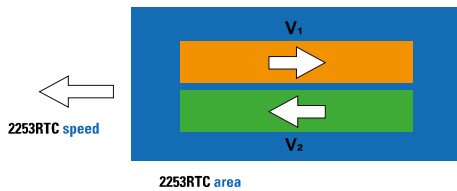

The speed of the gravity centre of the product is 7 m/min.

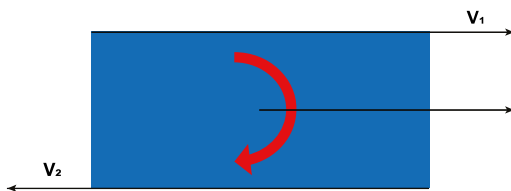

- Considering the angular speed ω of the pack the following relations are valid:

$$\alpha = \omega * t_a$$

$$\text{So } \omega = \frac{\alpha}{t_a} = \frac{\frac{\pi}{2}}{2} = 0.79 \text{ rad/s} = 47 \text{ rad/min}$$

1 m	= 3,28 ft
1 m/min	= 3,28 ft/min
1 m/s	= 3,28 ft/s



MATERIALS AND CALCULATIONS - General index **7 3 5 1 0 a** -

◀ back continue ▶

7 3 5 1 5 a Product handling

7 3 5 2 4 a 90° product transfer with belts

7 3 5 4 2 a Bearing selection

7 3 5 1 9 a Product handling maximum acceleration

7 3 5 2 6 a Thermal expansion

7 3 5 4 7 a Bearing and shaft

7 3 5 2 2 a Pressure of accumulation products

7 3 5 2 8 a 2500RR calculations

7 3 5 7 8 a Coefficient of friction of standard materials



Chains & sprockets	Wear strips	Side guide brackets & accessories	Levelers	Engineering manual
Modular belts & sprockets	Chain & belt return systems	Frame & structure supports	Bearing supports	
Curves & tracks	Side guide solutions	Miscellaneous products	Equipment	

7 3 5 3 9 a

2253RTC CALCULATIONS

2253 ROLLER TOP BELT



The required difference speed to rotate the product will be:

$$(V_1 - V_2) = 0.79 * 225 = 0.17 \text{ m/s} = 11 \text{ m/min}$$

◀ back continue ▶

Another way to calculate the difference in speed of balls can be used. See following relation:

Considering V_{a1} , the speed given to the auxiliary belt (1) and opposite in respect to V_1 (actual speed of balls under auxiliary belt (1));



Similarly, but opposite in running direction is V_{a2} :



Thus:

$$(V_1 - V_2) = 2 * V_{RT} + V_{a1} - (2 * V_{RT} - V_{a2}) = V_{a1} + V_{a2} = 11 \text{ [m/min]}$$

From the above relation is therefore possible to determine the real speeds V_{a1} and V_{a2} of the auxiliary belts by combining two speeds at choice V_1 and V_2 .

For instance, considering fixed the difference in speed $(V_1 - V_2)$:

$$(V_1 - V_2) = 11 \text{ m/min ;}$$

$$V_1 = 20 \text{ m/min ;}$$

$$V_2 = V_1 + 11 \text{ m/min} = (20 + 11) \text{ m/min} = 31 \text{ m/min.}$$

The auxiliary belt (1) will run in the same sense of the main belt with a speed V_{a1} .

$$V_{a1} = V_1 - 2 * V_{RT} = (20 - 7 * 2) \text{ m/min} = 6 \text{ m/min}$$

While the auxiliary belt (2) will run in the opposite sense of the main belt with a speed $V_{a2} = 31 - 7 * 2 = 17 \text{ m/min}$

$$V_{a2} = V_2 - 2 * V_{RT} = (31 - 7 * 2) \text{ m/min} = 17 \text{ m/min}$$

2253RTC
Construction details.
Go to:

7 2 2 9 0 a

2253RTC
Applications.
Go to:

7 2 6 2 5 a



1 m	= 3.28 ft
1 m/min	= 3.28 ft/min
1 m/s	= 3.28 ft/s

MATERIALS AND CALCULATIONS - General index 7 3 5 1 0 a -

◀ back continue ▶

7 3 5 1 5 a Product handling

7 3 5 2 4 a 90° product transfer with belts

7 3 5 4 2 a Bearing selection

7 3 5 1 9 a Product handling maximum acceleration

7 3 5 2 6 a Thermal expansion

7 3 5 4 7 a Bearing and shaft

7 3 5 2 2 a Pressure of accumulation products

7 3 5 2 8 a 2500RR calculations

7 3 5 7 8 a Coefficient of friction of standard materials



Chains & sprockets	Wear strips	Side guide brackets & accessories	Levelers	Engineering manual
Modular belts & sprockets	Chain & belt return systems	Frame & structure supports	Bearing supports	
Curves & tracks	Side guide solutions	Miscellaneous products	Equipment	

7 3 5 4 0 a

2253RTC CALCULATIONS

2253 ROLLER TOP BELT

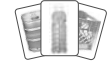

◀ back

In case of use of two speeds opposite to the running direction of the product (Fig. A), the following relation is valid:

$$(V_1 - V_2) = 2 * V_{RT} + V_{a1} - (2 * V_{RT} + V_{a2}) = V_{a1} - V_{a2} \text{ m/min}$$

This configuration requires higher speeds of the auxiliary belts and has the main advantage of the better control and stable product rotation.

At last, it is also possible to use a fixed plate instead of one of the two auxiliary belts (Fig. B).

This solution makes application cheaper (one less drive and auxiliary belt) but has the disadvantage to lead to a higher speed of the auxiliary belt, thus potential higher wear rate.

The infeed is needed to have a stable pack before the rotation (head to tail passage can affect the stability).

The infeed length should be at least as big as the product length: 360 mm ≈ 400 mm

The outfeed is recommended too but not mandatory.

The outfeed length should be in the same dimension range of the dimension of the pack once rotated (Wp): 240 mm ≈ 250 mm.

The overall footprint or length of the roller top and auxiliary belts system will be the sum of infeed, outfeed and shift area length.

Overall footprint = (400 + 700 + 250) mm = 1350 mm.

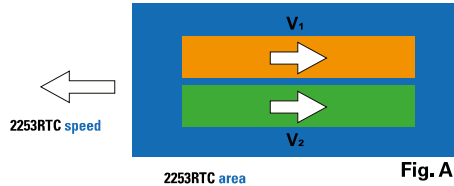

Fig. A

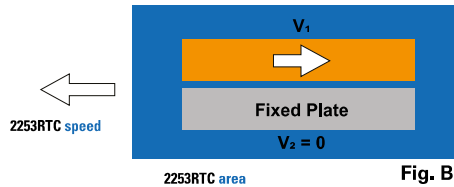

Fig. B

2253RTC Construction details. Go to: **7 2 2 9 0 a**

2253RTC Applications. Go to: **7 2 6 2 5 a**



Note: The SSL (Short Side Leading) rotation is generally less efficient than LSL (Long Side Leading) since the number of balls in contact at the beginning as well as arm of rotation is smaller.

Rotation could therefore seem not to start immediately and then be sudden.

In case of high speed differentials of $(V_1 - V_2)$ is recommendable to increase the auxiliary belts area (the length) to speeds lower and thus realize a smoother rotation.

For a properly working rotation we advise a **length/width ratio of max. 2**

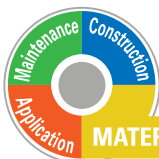

1 m	= 3.28 ft
1 m/min	= 3.28 ft/min
1 m/s	= 3.28 ft/s

MATERIALS AND CALCULATIONS - General index **7 3 5 1 0 a**

◀ back

7 3 5 1 5 a Product handling

7 3 5 2 4 a 90° product transfer with belts

7 3 5 4 2 a Bearing selection

7 3 5 1 9 a Product handling maximum acceleration

7 3 5 2 6 a Thermal expansion

7 3 5 4 7 a Bearing and shaft

7 3 5 2 2 a Pressure of accumulation products

7 3 5 2 8 a 2500RR calculations

7 3 5 7 8 a Coefficient of friction of standard materials

Chains & sprockets	Wear strips	Side guide brackets & accessories	Levelers	Engineering manual
Modular belts & sprockets	Chain & belt return systems	Frame & structure supports	Bearing supports	
Curves & tracks	Side guide solutions	Miscellaneous products	Equipment	

7 3 5 4 2 a BEARING SELECTION

BEARING

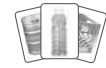

continue ►

Bearing mounting. Go to:

7 3 0 5 2 a

BEARING SELECTION:

The following general information will serve the purpose of aiding the machine designer or bearing user when applying the bearings covered in System Plast® catalog.

Before beginning the bearing selection for a particular application, it is important to have a good idea of where the bearing will be installed, what its purpose will be, what operating conditions will the bearing be expected to function in, and a desired bearing life. Each bearing type has certain characteristics which make it suitable for a certain application(s). Having comprehensive knowledge of these requirements will aid in bearing selection. In most cases, there are several factors to consider when choosing a bearing type. Therefore, the following information is to be used only as a guide. In the selection process the following factors must be considered:

magnitude and direction of load; misalignment (static or dynamic), noise; vibration and shock loading, environment and bearing type.

LOAD - MAGNITUDE AND DIRECTION

Load magnitude typically dictates size of bearing required but it can also affect the type of bearing. Ball bearings work well in light to moderate loads typical of conveyor applications. Load direction can be radial, axial, or a combination of these two directions. These directions along with load magnitude are deciding factors in selection of bearing type.

System Plast® bearings are mostly used in application where there are only radial load or radial loading plus slight axial load.

Radial loading is the most common type of bearing load and is defined as a load perpendicular to the shaft center line. Most ball bearings are designed to accept primarily radial loads.

Axial loading is defined as loading in the direction through the shaft centerline.

Combination loading consists of both a radial and a thrust load acting simultaneously on the bearing. When combination loads are acting on a bearing it is necessary to determine an equivalent radial load when calculating bearing life.

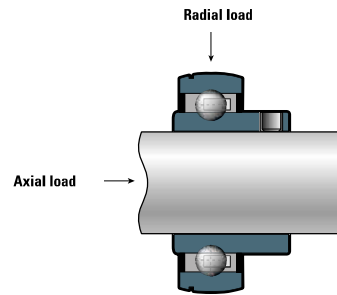

MISALIGNMENT

Bearing misalignment is a result of angular misalignment between the shaft and housing. This misalignment comes in two different forms, static and dynamic. Static misalignment is the outcome of bearings that are mounted on different planes causing an angular shaft displacement and resulting in the bearing operating under fixed misalignment angle. Mounted ball bearings have a design feature that allows them to accommodate a limited degree of fixed misalignment. Dynamic misalignment is an eccentric shaft rotation caused by shafting imperfections and resulting in the bearing operating under a varying misalignment angle.

Static System Misalignment

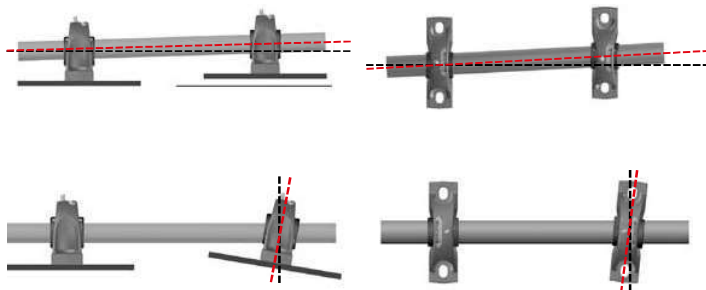

Dynamic System Misalignment

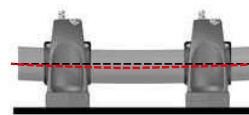

Each bearing type is capable of accommodating a certain amount of either static, dynamic, or combination misalignment. When application misalignment exceeds the allowable limit for the particular bearing, increased contact stresses between bearing rolling elements and raceways occurs and bearing life is reduced. Individual product sections contain additional information regarding degrees of misalignment each bearing type is capable of handling.



MATERIALS AND CALCULATIONS - General index 7 3 5 1 0 a -

continue ►

7 3 5 4 7 a Bearing and shaft

7 3 5 2 2 a Pressure of accumulation products

7 3 5 2 8 a 2500RR calculations

7 3 5 1 5 a Product handling

7 3 5 2 4 a 90° product transfer with belts

7 3 5 3 3 a 2253RTC calculations

7 3 5 1 9 a Product handling maximum acceleration

7 3 5 2 6 a Thermal expansion

7 3 5 7 8 a Coefficient of friction of standard materials



Chains & sprockets	Wear strips	Side guide brackets & accessories	Levelers	Engineering manual
Modular belts & sprockets	Chain & belt return systems	Frame & structure supports	Bearing supports	
Curves & tracks	Side guide solutions	Miscellaneous products	Equipment	

7 3 5 4 3 a BEARING SELECTION

BEARING

NOISE:

Noise sensitive applications require smooth running of bearings. These are typically low duty environments which makes ball bearings a good choice. Concentric or Skwezloc® locking mechanisms are preferred to keep vibration at a minimum.

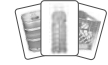

◀ back continue ▶

VIBRATION AND SHOCK LOADING:

Vibration and shock loading can be present in some applications and can transfer large forces to bearings and accompanying raceways. These loads create large stresses at the interface between the rolling elements and raceways and can cause considerable damage and a reduction of bearing life.

Bearing mounting.
Go to:

7 3 0 5 2 a

ENVIRONMENT:

Environmental factors such as solids contamination exposure to moisture and thermal conditions are important variables in bearing selection. Bearing components (seals, grease, bearing material, etc..) can be modified in order to better suit a specialized application. Availability of special features may be affected by shaft size, bearing type, and housing type therefore this must be considered in the bearing selection process. Individual product sections contain additional information regarding these specialized features and availability.

BEARING TYPE: RADIAL BALL BEARINGS

Radial ball bearings create a fairly small elliptical contact between the ball-path and rolling element thus distributing loads across a small area. Surface contact is minimized and less friction and heat is generated which allows ball bearings a higher speed range. This small contact area also limits ball bearings to accepting only light to moderate loads. Radial ball bearings have a zero-degree free contact angle but can accept light thrust loads (in combination with a radial load) due to the shape geometry of their raceways. Mounted ball bearing units have some degree of external static self-aligning capability (the bearing insert can misalign with respect to the housing). Mounted ball bearings come in a variety of housing styles and features to suit a wide variety of applications. Only "radial" ball-bearing type are available from System Plast® product range.



MATERIALS AND CALCULATIONS - General index 7 3 5 1 0 a -

◀ back continue ▶

7 3 5 4 7 a Bearing and shaft

7 3 5 2 2 a Pressure of accumulation products

7 3 5 2 8 a 2500RR calculations

7 3 5 1 5 a Product handling

7 3 5 2 4 a 90° product transfer with belts

7 3 5 3 3 a 2253RTC calculations

7 3 5 1 9 a Product handling maximum acceleration

7 3 5 2 6 a Thermal expansion

7 3 5 7 8 a Coefficient of friction of standard materials



Chains & sprockets	Wear strips	Side guide brackets & accessories	Levelers	Engineering manual
Modular belts & sprockets	Chain & belt return systems	Frame & structure supports	Bearing supports	
Curves & tracks	Side guide solutions	Miscellaneous products	Equipment	

7 3 5 4 4 a BEARING SELECTION

BEARING

BEARINGS DRAWING EXPLODED VIEW

FREE MAINTENANCE BEARING: TRIATHLON® WASHDOWN BEARING - 2 HOLE VERSIONS - SKWEZLOC® BEARING

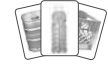

◀ back continue ▶

Bearing mounting.
Go to:

7 3 0 5 2 a

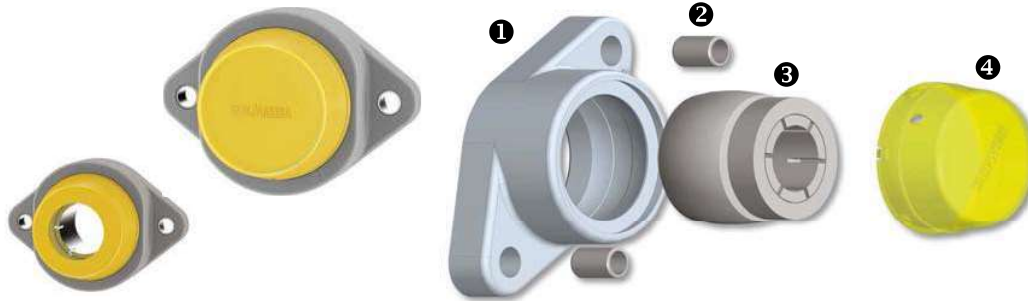

POS.	ITEM DESCRIPTION	QTY
1	Bearing housing machined oval	1
2	Spacer Ø 14mm	2
3	Bearing PN-206T with SKWEZLOC® concentric locking collar	1
4	Safety cap	1

FLANGED HOUSINGS - 2 HOLE VERSIONS - GRUB SCREW LOCK

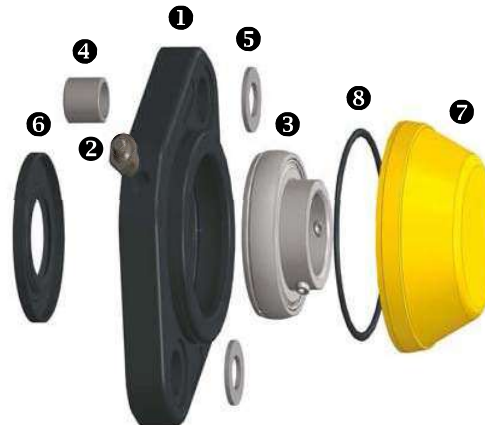

POS.	ITEM DESCRIPTION	QTY
1	Bearing housing machined oval	1
2	Grease nipple 1/8"	1
3	Bearing with screw	1
4	Spacer Ø 14mm	2
5	Washer	2
6	Heavy ring double lips	1
7	Safety cap	1
8	O-ring	1

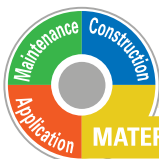

MATERIALS AND CALCULATIONS - General index 7 3 5 1 0 a -

◀ back continue ▶

7 3 5 4 7 a Bearing and shaft

7 3 5 2 2 a Pressure of accumulation products

7 3 5 2 8 a 2500RR calculations

7 3 5 1 5 a Product handling

7 3 5 2 4 a 90° product transfer with belts

7 3 5 3 3 a 2253RTC calculations

7 3 5 1 9 a Product handling maximum acceleration

7 3 5 2 6 a Thermal expansion

7 3 5 7 8 a Coefficient of friction of standard materials



Chains & sprockets	Wear strips	Side guide brackets & accessories	Levelers	Engineering manual
Modular belts & sprockets	Chain & belt return systems	Frame & structure supports	Bearing supports	
Curves & tracks	Side guide solutions	Miscellaneous products	Equipment	

7 3 5 4 5 a BEARING SELECTION

BEARING

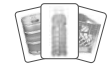

◀ back

Bearing mounting.
Go to:

7 3 0 5 2 a

FLANGED HOUSINGS - 4 HOLE VERSIONS - ECCENTRIC LOCK

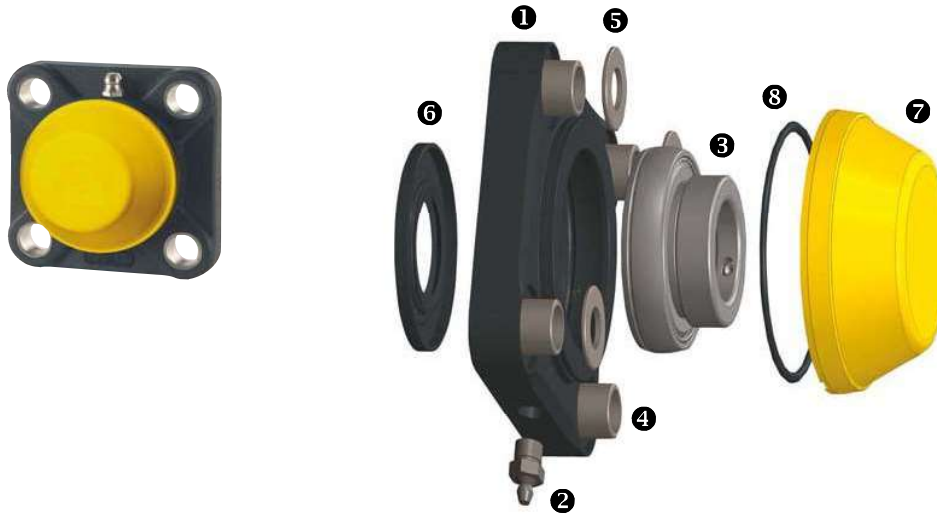

POS.	ITEM DESCRIPTION	QTY
1	Bearing Housing	1
2	Grease nipple 1/8"	1
3	Bearing with eccentric ring	1
4	Spacer	4
5	Washer	4
6	Heavy ring double lips	1
7	Safety cap	1
8	O-ring	1



MATERIALS AND CALCULATIONS - General index 7 3 5 1 0 a -

◀ back

7 3 5 4 7 a Bearing and shaft

7 3 5 2 2 a Pressure of accumulation products

7 3 5 2 8 a 2500RR calculations

7 3 5 1 5 a Product handling

7 3 5 2 4 a 90° product transfer with belts

7 3 5 3 3 a 2253RTC calculations

7 3 5 1 9 a Product handling maximum acceleration

7 3 5 2 6 a Thermal expansion

7 3 5 7 8 a Coefficient of friction of standard materials



Chains & sprockets	Wear strips	Side guide brackets & accessories	Levelers	Engineering manual
Modular belts & sprockets	Chain & belt return systems	Frame & structure supports	Bearing supports	
Curves & tracks	Side guide solutions	Miscellaneous products	Equipment	

7 3 5 4 7 a

BEARING AND SHAFT

BEARING

SHAFT SIZE:

THE SHAFT MUST FULFILL THE FOLLOWING CONDITIONS:

- Maximum shaft deflection F_{max} under full load (F_w) is 2,5 mm (0.10 in). If the calculated shaft deflection exceeds this max value, select a bigger shaft size or install an intermediate supported bearing on the shaft.
- Torque (**Ts**) at maximum load must be below critical value;
Shaft maximum deflection under concentrated load applied in the center can be calculated with following formula:

2 BEARINGS

$$f = \frac{5}{384} * F_w \frac{l_b^3}{E * I} \text{ [mm]: } F_w \text{ [N], } l_b \text{ [mm], } I \text{ [mm}^4\text{], } E \left[\frac{\text{N}}{\text{mm}^2} \right]$$

$$f = \frac{5}{384} * F_w \frac{l_b^3}{E * I} \text{ [in]: } F_w \text{ [lb], } l_b \text{ [in], } I \text{ [in}^4\text{], } E \left[\frac{\text{lb}}{\text{in}^2} \right]$$

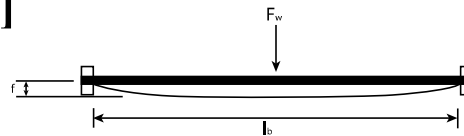

3 BEARINGS

$$f = \frac{1}{370} * F_w \frac{l_b^3}{E * I} \text{ [mm]: } F_w \text{ [N], } l_b \text{ [mm], } I \text{ [mm}^4\text{], } E \left[\frac{\text{N}}{\text{mm}^2} \right]$$

$$f = \frac{1}{370} * F_w \frac{l_b^3}{E * I} \text{ [in]: } F_w \text{ [lb], } l_b \text{ [in], } I \text{ [in}^4\text{], } E \left[\frac{\text{lb}}{\text{in}^2} \right]$$

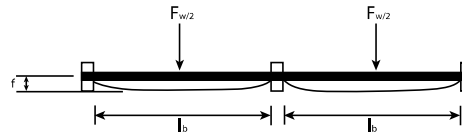

For uni-directional head drive $F_w = T$,

For bi-directional center drive $F_w = 2 * T$,

For uni-directional pusher drives $F_w = 2.2 * T$,

For modulus of elasticity (E) use: 200,000 N/mm² or 28,500,000 lb/in². Values are for carbon steel (C50) or stainless steel AISI 304/316. Modulus of elasticity for other materials can be referenced via industry standards.

MOMENT OF INERTIA FOR SOLID SHAFTS (I)			
SHAFT SIZE		INERTIA	
mm	in.	mm ⁴	in ⁴
SQUARE SHAFTS			
25	-	32552	-
40	-	213333	-
60	-	1080000	-
90	-	5467500	-

MOMENT OF INERTIA FOR SOLID SHAFTS (I)			
SHAFT SIZE		INERTIA	
mm	in.	mm ⁴	in ⁴
ROUND SHAFTS			
20	-	7850	-
25	-	19150	-
30	-	39750	-
35	-	73650	-
40	-	125600	-
45	-	201200	-
50	-	306650	-
55	-	449000	-
60	-	635850	-
80	-	2009600	-
90	-	3220000	-
-	1	-	0.049
-	1,1875	-	0.098
-	1,25	-	0.120
-	1,4375	-	0.210
-	1,5	-	0,248

Moment of inertia can be calculated for all shaft diameter and shape. It's a geometrical property of the shaft.



MATERIALS AND CALCULATIONS - General index **7 3 5 1 0 a**

continue ►

7 3 5 4 2 a Bearing selection

7 3 5 2 2 a Pressure of accumulation products

7 3 5 2 8 a 2500RR calculations

7 3 5 1 5 a Product handling

7 3 5 2 4 a 90° product transfer with belts

7 3 5 3 3 a 2253RTC calculations

7 3 5 1 9 a Product handling maximum acceleration

7 3 5 2 6 a Thermal expansion

7 3 5 7 8 a Coefficient of friction of standard materials

Chains & sprockets	Wear strips	Side guide brackets & accessories	Levelers	Engineering manual
Modular belts & sprockets	Chain & belt return systems	Frame & structure supports	Bearing supports	
Curves & tracks	Side guide solutions	Miscellaneous products	Equipment	

7 3 5 4 8 a

BEARING AND SHAFT

BEARING

BEARING CALCULATIONS FOR SERIES UC AND UF:

STATIC LOAD CALCULATION:

In case the bearing is loaded without rotating, very slowly rotating or is making a slow oscillating movement, the bearing power is not determined by the fatigue life of the material but by the deformation of the rollers and the groove. This calculation is also valid if at a fraction of the rotation a shock load is present.

$$P_0 = X_0 * F_r + Y_0 * F_a = 0.6 * F_r + 0.5 * F_a$$

P_0 equivalent static load [N];

X_0 radial static factor;

F_r radial load [N];

Y_0 axial static factor;

F_a axial load [N];

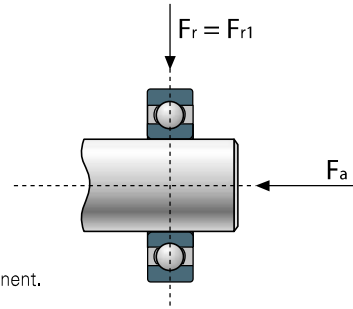

◀ back continue ▶

Bearing mounting.
Go to:

7 3 0 5 2 a

P_0 is calculated when there is not only a radial component in the load but also an axial component.

When the load on the bearing is strictly radial the equivalent static load $P_0 = F_r$.

The minimum static load coefficient C_0 is calculated while taking into account the static safety factor S_0 .

Then in the bearing tables the right size bearing can be found checking the C_0 .

$$C_0 = S_0 * P_0$$

C_0 static load coefficient in [N]

S_0 static safety factor;

$S_0 = 1$ for normal circumstances,

= 1.5 when vibrations are involved and

= 2 - 2.5 for noiseless applications.

DYNAMIC LOAD CALCULATION:

For normal circumstances, the dynamic load coefficient is calculated and compared to the equivalent dynamic load to determine the theoretical service life of the bearing. The calculated service life is then compared to the standard for the application and industry.

$$L_{10} = \left(\frac{C}{P} \right)^3$$

L_{10} = nominal life time in millions of revolutions
 C = dynamic load coefficient in [N]
 P = equivalent dynamic load [N]

When bearings run at constant speed, their life can be determined in working hours:

$$L_{10h} = \frac{1.000.000}{60n} * \left(\frac{C}{P} \right)^3$$

L_{10h} = life in hours.
 n = speed [rpm].

When the load on the bearing is strictly radial the equivalent dynamic load $P = F_r$.

When there's also an axial load involved the equivalent dynamic load is:

$$P = X * F_r + Y * F_a$$

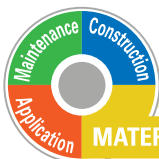

MATERIALS AND CALCULATIONS - General index 7 3 5 1 0 a -

◀ back continue ▶

7 3 5 4 2 a Bearing selection

7 3 5 2 2 a Pressure of accumulation products

7 3 5 2 8 a 2500RR calculations

7 3 5 1 5 a Product handling

7 3 5 2 4 a 90° product transfer with belts

7 3 5 3 3 a 2253RTC calculations

7 3 5 1 9 a Product handling maximum acceleration

7 3 5 2 6 a Thermal expansion

7 3 5 7 8 a Coefficient of friction of standard materials



Chains & sprockets	Wear strips	Side guide brackets & accessories	Levelers	Engineering manual
Modular belts & sprockets	Chain & belt return systems	Frame & structure supports	Bearing supports	
Curves & tracks	Side guide solutions	Miscellaneous products	Equipment	

7 3 5 4 9 a BEARING AND SHAFT

BEARING



◀ back continue ▶

X radial dynamic factor;

Y axial dynamic factor;

The axial force only influences the equivalent dynamic load when $F_a / F_r > E$

CALCULATION FACTORS					
F_a / C_0	E	$F_a / F_r < E$		$F_a / F_r > E$	
		X	Y	X	Y
0.025	0.22	1	0	0.56	2
0.04	0.24	1	0	0.56	1.8
0.07	0.27	1	0	0.56	1.6
0.13	0.31	1	0	0.56	1.4
0.25	0.37	1	0	0.56	1.2
0.5	0.44	1	0	0.56	1

Bearing mounting.
Go to:

7 3 0 5 2 a

THE AXIAL LOAD SHOULD NEVER EXCEED 20% OF THE DYNAMIC LOAD COEFFICIENT (C).

INDICATIVE SPEED FOR SHAFT TOLERANCES:

SHAFT DIAMETER		SHAFT TOLERANCES				
		h6	h7	h8	h9	h11
Limiting speeds - Shaft tolerance						
mm	in.	RPM				
Ø12	-	9500	6000	4300	1500	950
Ø15	-	9500	6000	4300	1500	950
Ø16	-	9500	6000	4300	1500	950
Ø17	-	9500	6000	4300	1500	950
Ø20	-	8500	5300	3800	1300	850
Ø25	-	7000	4500	3200	1000	700
Ø30	-	6300	4000	2800	900	630
Ø35	-	5300	3400	2200	750	530
Ø40	-	4800	3000	1900	670	480
-	Ø1	7000	4500	3200	1000	700
-	Ø1 3/16	6300	4000	2800	900	630
-	Ø1 1/4	5600	3600	2500	800	550
-	Ø1 7/16	5300	3400	2200	750	530
-	Ø1 1/2	5000	3100	2000	700	500



MATERIALS AND CALCULATIONS - General index 7 3 5 1 0 a -

◀ back continue ▶

7 3 5 4 2 a Bearing selection

7 3 5 2 2 a Pressure of accumulation products

7 3 5 2 8 a 2500RR calculations

7 3 5 1 5 a Product handling

7 3 5 2 4 a 90° product transfer with belts

7 3 5 3 3 a 2253RTC calculations

7 3 5 1 9 a Product handling maximum acceleration

7 3 5 2 6 a Thermal expansion

7 3 5 7 8 a Coefficient of friction of standard materials

Chains & sprockets	Wear strips	Side guide brackets & accessories	Levelers	Engineering manual
Modular belts & sprockets	Chain & belt return systems	Frame & structure supports	Bearing supports	
Curves & tracks	Side guide solutions	Miscellaneous products	Equipment	

7 3 5 5 0 a

BEARING AND SHAFT

BEARING

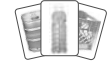

◀ back

MAXIMUM RADIAL LOAD CAPACITY OF HOUSING:

Values indicated in the table below, are obtained at 23°C. Value indicated: N, Values of polyamide version (values of polypropylene version in brackets). For further information please consult System Plast® SmartGuide® pages regarding bearing type you are interested in.

Series SQL ø mm				
12-15-16-17	6500	(-)	6000	(-)
20	5800	(-)	5300	(-)

Series UC FH/UC FH-R ø mm				
12-15-16-17	6500	(-)	7000	(-)
20	7000	(-)	7500	(-)
25	7500	(-)	8000	(-)
30	8000	(-)	8800	(-)
35	8500	(-)	9000	(-)

Bearing mounting. Go to:

7 3 0 5 2 a

Series UC FL/UC FL-W ø mm				
20	6900	(3200)	7500	(3500)
25	6750	(2950)	7200	(3000)
30	12000	(5800)	13000	(6000)
35	11000	(5300)	12800	(6000)
40	10800	(5100)	12850	(5800)

Series UC FQ/UC FQ-R ø mm				
12-15-16-17	12000	(-)	12000	(-)
20	12500	(-)	11500	(-)
25	12500	(-)	11500	(-)
30	12800	(-)	11000	(-)
35	12300	(-)	10500	(-)
40	12000	(-)	10000	(-)

Series UC PA/UC PA-R ø mm						
20	6500	(3000)	2000	(1000)	4000	(1600)
25	7800	(3200)	2500	(1400)	4800	(1800)
30	11000	(4000)	2900	(1500)	5700	(2000)

Series UC T/UC T-R ø mm						
20	7800	(3200)	2500	(1400)	4800	(1800)
25	6500	(3000)	2000	(1000)	4000	(1600)
30	12000	(5500)	3500	(1800)	6000	(2400)
35	10000	(3600)	2900	(1500)	5500	(2000)

Series UC FG/UC FG-R ø mm				
20	12000	(-)	10000	(-)
25	12500	(-)	11000	(-)
30	12800	(-)	11500	(-)

Series UC HE/UC HE-R ø mm						
20	10000	(3600)	2500	(1400)	4800	(1800)
25	8500	(3200)	2000	(1000)	4000	(1600)
30	14000	(6500)	3500	(1800)	6000	(2400)
35	12000	(5500)	2900	(1500)	5500	(2000)

Series UC FA/UC FA-R ø mm						
20	8000	(-)	2000	(-)	2500	(-)
25	8500	(-)	3000	(-)	3000	(-)
30	9000	(-)	3500	(-)	3500	(-)



MATERIALS AND CALCULATIONS - General index 7 3 5 1 0 a -

◀ back

7 3 5 4 2 a Bearing selection

7 3 5 2 2 a Pressure of accumulation products

7 3 5 2 8 a 2500RR calculations

7 3 5 1 5 a Product handling

7 3 5 2 4 a 90° product transfer with belts

7 3 5 3 3 a 2253RTC calculations

7 3 5 1 9 a Product handling maximum acceleration

7 3 5 2 6 a Thermal expansion

7 3 5 7 8 a Coefficient of friction of standard materials

Chains & sprockets	Wear strips	Side guide brackets & accessories	Levelers	Engineering manual
Modular belts & sprockets	Chain & belt return systems	Frame & structure supports	Bearing supports	
Curves & tracks	Side guide solutions	Miscellaneous products	Equipment	

7 3 5 6 0 a **STEEL CHAIN MATERIALS**
MATERIALS

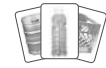

continue ►

Index chains.
Go to product page:
1 1 0 1 0 a

C45



CARBON STEEL: S AND SR

C45 steel material allows a higher yield load capability than stainless steel but is not corrosion resistant, thus only suitable for dry environments. Oil lubrication may be necessary to reduce rust and drag. The through hardened plate material provides a uniform hardness and a high abrasion resistance.

FEATURES:

- Surface hardness: 44 HRC

BENEFITS:

- High mechanical strength
- High abrasion resistance

STANDARD



STANDARD STAINLESS STEEL: SS AND SSL

AISI 430 Stainless steel material with good mechanical characteristics and corrosion resistance. An economical option for many conveying applications.

Lower load and lower wear resistance capability than our higher grade stainless steel materials.

FEATURES:

- Standard stainless steel

BENEFITS:

- Food grade
- Economical solution

EXTRA PLUS



EXTRA PLUS STAINLESS STEEL: SSE, SSSR, SSEL AND SPSP

High performance stainless steel, specially developed for high speed and heavy-duty application. Offers excellent corrosion resistance and surface hardness.

FEATURES:

- Surface hardness of HRC 26-30
- Extremely flat and smooth surface finish
- High corrosion and wear resistance
- Highest ultimate yield loading capability

BENEFITS:

- Food grade
- Typically used in glide liners and pressureless combiners and very long conveyors
- For improved product stability

AUSTENITIC



AUSTENITIC STAINLESS STEEL: SSA

AISI 304 Austenitic stainless steel which offers high corrosion and acid resistance properties.

FEATURES:

- Stainless steel with 18% chrome and 8% nickel

BENEFITS:

- Food grade
- High corrosion and acid resistance material

HIGH STRENGTH	FOOD GRADE	MEDIUM HIGH SPEED	VERY HIGH SPEED	CORROSION RESISTANCE	CHEMICAL RESISTANCE



MATERIALS AND CALCULATIONS - General index **7 3 5 1 0 a** -

continue ►

7 3 5 7 3 a Nolu®-S parts

7 3 5 7 8 a Coefficient of friction of standard materials

7 3 5 8 6 a Chemical resistance of standard materials

7 3 5 7 6 a Storage of plastic chains and belts & RoHS

7 3 5 8 0 a Coefficient of friction - Measurement procedure

7 3 5 8 8 a Application temperatures

Chains & sprockets	Wear strips	Side guide brackets & accessories	Levelers	Engineering manual
Modular belts & sprockets	Chain & belt return systems	Frame & structure supports	Bearing supports	
Curves & tracks	Side guide solutions	Miscellaneous products	Equipment	

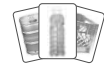

7 3 5 6 1 a PIN MATERIALS FOR STEEL AND PLASTIC CHAINS MATERIALS

◀ back continue ▶

SPM

STANDARD PIN MATERIAL

Special stainless steel with higher tensile strength and improved surface hardness. These pins are offered as standard in most stainless steel and plastic chains.



FEATURES:

- High wear, corrosion and acid resistance

BENEFITS:

- Longer wear life

HB

SPECIAL PIN MATERIAL

Vacuum hardened stainless steel with exceptionally high wear resistance characteristics, good corrosion and chemical resistance, for high speed and or abrasive applications with steel chain.



Pin wear is the main contributing factor in chain elongation.

Due to their extraordinary hardness, HB pins offer a much better resistance against mechanical/abrasive wear and thus extended service life of chain.

HB (Harten Bolzen) pins are recommended for the following operating conditions and applications:

- Abrasive environment (e.g. crate and bottle conveyors)
- Short conveyors running at high speed (e.g. filler area, inspector sections, pressure less combiners)
- High load applications (e.g. accumulation area, full crate conveyors, full bottle accumulation tables, keg lines)

FEATURES:

- Hardness > HRC 48

BENEFITS:

- Ultimate abrasion resistance
- Outstanding wear life
- Wear resistance twice of standard pin

SPECIAL PIN MATERIAL HB vs STANDARD PIN MATERIAL SPM

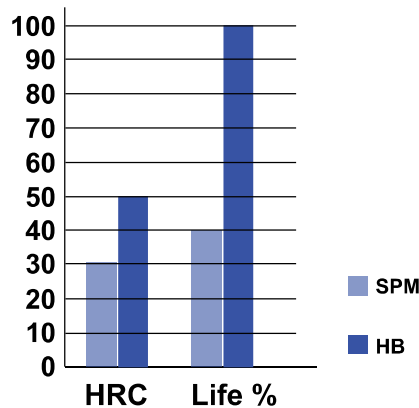

HIGH STRENGTH	VERY HIGH SPEED	CORROSION RESISTANCE	CHEMICAL RESISTANCE



MATERIALS AND CALCULATIONS - General index 7 3 5 1 0 a -

◀ back continue ▶

7 3 5 7 3 a Nolu®-S parts

7 3 5 7 8 a Coefficient of friction of standard materials

7 3 5 8 6 a Chemical resistance of standard materials

7 3 5 7 6 a Storage of plastic chains and belts & RoHs

7 3 5 8 0 a Coefficient of friction - Measurement procedure

7 3 5 8 8 a Application temperatures



Chains & sprockets	Wear strips	Side guide brackets & accessories	Levelers	Engineering manual
Modular belts & sprockets	Chain & belt return systems	Frame & structure supports	Bearing supports	
Curves & tracks	Side guide solutions	Miscellaneous products	Equipment	

7 3 5 6 2 a | PIN MATERIALS FOR STEEL AND PLASTIC CHAINS MATERIALS



◀ back continue ▶

PPM



PLASTIC PIN MATERIAL

Special reinforced acetal resin. For plastic chains only.

FEATURES:

- Optimum strength

BENEFITS:

- Ultimate abrasion resistance
- Outstanding wear life
- Suitable for metal detection applications

FPM



FERRITIC STEEL PIN MATERIAL FOR MAGNETIC CHAINS

Ferritic Stainless-Steel pin is used for magnetic side-flexing chains. This material offers a great retention force in combination with magnetic curve.

FEATURES:

- High wear resistance

BENEFITS:

- Optimum retention force
- Longer wear life

SUITABLE FOR METAL DETECTION APPLICATION	MAGNETIC



MATERIALS AND CALCULATIONS - General index 7 3 5 1 0 a -

◀ back continue ▶

7 3 5 7 3 a Nolu®-S parts

7 3 5 7 8 a Coefficient of friction of standard materials

7 3 5 8 6 a Chemical resistance of standard materials

7 3 5 7 6 a Storage of plastic chains and belts & RoHS

7 3 5 8 0 a Coefficient of friction - Measurement procedure

7 3 5 8 8 a Application temperatures

Chains & sprockets	Wear strips	Side guide brackets & accessories	Levelers	Engineering manual
Modular belts & sprockets	Chain & belt return systems	Frame & structure supports	Bearing supports	
Curves & tracks	Side guide solutions	Miscellaneous products	Equipment	

7 3 5 6 3 a **PLASTIC CHAIN AND BELT MATERIALS**
MATERIALS

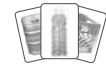

◀ back continue ▶

LF

LOW FRICTION ACETAL RESIN

This material is commonly used in the market and offers an improved coefficient of friction. It is also suitable for use in high speed applications.

LFG

Plastic Chain Color: Light Brown (LF), Dark Grey (LFG) or White (LFW)

LFB

Plastic Belt Color: Grey (LFG); Blue (LFB); white (LFW)

LFW

FEATURES:

- Optimum strength and wear life

BENEFITS:

- Food grade



Index chains.
Go to:
1 1 0 1 0 a

Index plastic belts.
Go to:
3 0 0 1 0 a

NG®evo

NG®evo conveyor components made from engineered plastic resin

Extra performance PBT with lowest coefficient of friction in our range, resulting in good strength and optimum wear resistance, reduced plate wear and reduced pitch elongation.

Available exclusively from Regal® System Plast® product.

Color: Grey Blue

FEATURES:

- Optimum strength and wear life
- Lowest coefficient of friction
- Optimum abrasive resistance
- Higher operating temperature in dry conditions

BENEFITS:

- Food grade
- High speed application
- Dry running application



HIGH STRENGTH	FOOD GRADE	MEDIUM HIGH SPEED	VERY HIGH SPEED	VERY LOW COEFFICIENT OF FRICTION



MATERIALS AND CALCULATIONS - General index **7 3 5 1 0 a** -

◀ back continue ▶

7 3 5 7 3 a Nolu®-S parts

7 3 5 7 8 a Coefficient of friction of standard materials

7 3 5 8 6 a Chemical resistance of standard materials

7 3 5 7 6 a Storage of plastic chains and belts & RoHS

7 3 5 8 0 a Coefficient of friction - Measurement procedure

7 3 5 8 8 a Application temperatures

Chains & sprockets	Wear strips	Side guide brackets & accessories	Levelers	Engineering manual
Modular belts & sprockets	Chain & belt return systems	Frame & structure supports	Bearing supports	
Curves & tracks	Side guide solutions	Miscellaneous products	Equipment	

7 3 5 6 5 a SPECIAL PLASTIC CHAIN AND BELT MATERIALS MATERIALS

On request and for adequate quantities belts may be produced in other materials such as:



◀ back continue ▶

Index belts.
Go to:

3 0 0 1 0 a

AS



ANTI-STATIC ACETAL RESIN

Anti-static acetal material with improved surface conductivity for greater protection against static electrical discharges.

Color: Black (AS)

FEATURES:

- Antistatic

BENEFITS:

- Dissipates nuisance static build-up

HT



HIGH TEMPERATURE RESISTANT

Polyamide material based for high temperature applications up to 140°C.

Color: Natural white

BENEFITS:

- High temperature resistance
- Food grade

XT



EXTRA TEMPERATURE

This material with fiber glass-reinforced offers an excellent heat and chemical resistance for belt/chain and a good load capacity in respect to other materials. XT is suitable for extra high temperature applications up to 240° C.

Color: Beige

BENEFITS:

- Very high temperature up to 240°C

PP

PPW



CHEMICAL RESISTANCE

For belts: polypropylene material for greater chemical and temperature resistance. Polypropylene has lower mechanical strength than acetal. For belts (PP) the pins and clips are also made of Polypropylene.

Color: Beige (PP), White (PPW).

BENEFITS:

- Food grade
- Higher temperature resistance
- Optimum chemical resistance

PPG

PPLG



HIGH STABILIZED HOMOPOLYMER

For belts: Polypropylene material for a greater chemical and temperature resistance. This Polypropylene is a high stabilized homopolymer, combining high impact strength and stiffness. It has been developed especially for high detergent resistance and heat stability. Apart from pasteurizers, this material is also used in industrial washing machines, heat exchangers and dishwashers.

Color: Dark Grey (PPG), Light Grey (PPLG).

BENEFITS:

- Food grade
- Higher temperature resistance
- Optimum chemical resistance

CR



For chains: reinforced polypropylene material for greater acid and chemical resistance. Polypropylene has lower mechanical strength than acetal. **Reinforced PP is not food grade.**

Color: White (CR, for chains only)

Special colours

On request and for adequate quantities, chains and belts may be produced in other colours.

FOOD GRADE	ANTISTATIC	HIGH TEMPERATURE RESISTANCE	VERY HIGH TEMPERATURE RESISTANCE	CHEMICAL RESISTANCE



MATERIALS AND CALCULATIONS - General index 7 3 5 1 0 a -

◀ back continue ▶

7 3 5 7 3 a Nolu®-S parts

7 3 5 7 8 a Coefficient of friction of standard materials

7 3 5 8 6 a Chemical resistance of standard materials

7 3 5 7 6 a Storage of plastic chains and belts & RoHS

7 3 5 8 0 a Coefficient of friction - Measurement procedure

7 3 5 8 8 a Application temperatures



Chains & sprockets	Wear strips	Side guide brackets & accessories	Levelers	Engineering manual
Modular belts & sprockets	Chain & belt return systems	Frame & structure supports	Bearing supports	
Curves & tracks	Side guide solutions	Miscellaneous products	Equipment	

7 3 5 6 6 a SPECIAL PLASTIC CHAIN AND BELT MATERIALS

PP-FR-EC



FLAME RETARDANT, ELECTRICALLY CONDUCTIVE POLYPROPYLENE

Flammability according to UL94 is classified as V0. Due to the very low surface resistivity, this material can be considered electrically conductive.

Colour: Black.

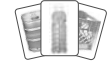

◀ back continue ▶

Special colours

On request and for adequate quantities, chains and belts may be produced in other colours.

FLAME RETARDANT	ELECTRICALLY CONDUCTIVE



MATERIALS AND CALCULATIONS - General index 7 3 5 1 0 a -

◀ back continue ▶

7 3 5 7 3 a Nolu®-S parts

7 3 5 7 8 a Coefficient of friction of standard materials

7 3 5 8 6 a Chemical resistance of standard materials

7 3 5 7 6 a Storage of plastic chains and belts & RoHS

7 3 5 8 0 a Coefficient of friction - Measurement procedure

7 3 5 8 8 a Application temperatures

Chains & sprockets	Wear strips	Side guide brackets & accessories	Levelers	Engineering manual
Modular belts & sprockets	Chain & belt return systems	Frame & structure supports	Bearing supports	
Curves & tracks	Side guide solutions	Miscellaneous products	Equipment	



7 3 5 6 8 a

PIN MATERIALS FOR BELTS MATERIALS

◀ back continue ▶

Index belts.
Go to:

3 0 0 1 0 a

PBT

PBT

Most commonly used pin material in System Plast® belts. This material offers a high abrasion resistance as well as a low noise operation.

POM

POM

Polyacetal pins are used in System Plast® belts. This pin material gives optimum strength.

PP

PP

Polypropylene pins are used in all belts made of PP material. The pin material is adapted to the high temperature and high chemical resistance of the belt material.

SS

SS

Ferritic stainless steel pin is used for side-flexing belt 2120M. This material offers a great retention force in combination with magnetic curve.



MATERIALS AND CALCULATIONS - General index 7 3 5 1 0 a -

◀ back continue ▶

7 3 5 7 3 a Nolu®-S parts

7 3 5 7 8 a Coefficient of friction of standard materials

7 3 5 8 6 a Chemical resistance of standard materials

7 3 5 7 6 a Storage of plastic chains and belts & RoHS

7 3 5 8 0 a Coefficient of friction - Measurement procedure

7 3 5 8 8 a Application temperatures

Chains & sprockets	Wear strips	Side guide brackets & accessories	Levelers	Engineering manual
Modular belts & sprockets	Chain & belt return systems	Frame & structure supports	Bearing supports	
Curves & tracks	Side guide solutions	Miscellaneous products	Equipment	



◀ back

7 3 5 7 0 a RUBBER MATERIALS MATERIALS

TPR

TPR (SEBS)

TPR is used for VG chains and belts and for plastic gripper chains. TPR is a SEBS type rubber, which assures an optimum bonding on the plastic base material.
Mechanical properties data available on MDS.

NBR

NBR

NBR rubber is used for our gripper chains serie 1874.
It offers a soft grip and a good resistance against oils.

EPDM

EPDM

EPDM rubber is used for our gripper chains.
It offers good weather and chemical resistance, although contact with oils, gasoline and concentrated acids must be avoided.

EPDM-PP

EPDM-PP

EPDM-PP rubber is used for our gripper chains.
It offers improved chemical resistance and can be used at higher temperatures.
Resistance against steam is good.



MATERIALS AND CALCULATIONS - General index 7 3 5 1 0 a -

◀ back

7 3 5 7 3 a Nolu®-S parts

7 3 5 7 8 a Coefficient of friction of standard materials

7 3 5 8 6 a Chemical resistance of standard materials

7 3 5 7 6 a Storage of plastic chains and belts & RoHS

7 3 5 8 0 a Coefficient of friction - Measurement procedure

7 3 5 8 8 a Application temperatures

Chains & sprockets	Wear strips	Side guide brackets & accessories	Levelers	Engineering manual
Modular belts & sprockets	Chain & belt return systems	Frame & structure supports	Bearing supports	
Curves & tracks	Side guide solutions	Miscellaneous products	Equipment	



continue ►

7 3 5 7 3 a

NOLU®-S
MATERIALS

WHAT ARE NOLU PLASTICS?

Nolu® plastic parts are made with Regal's exclusive compounds of UHMWPE and solid lubricants/unique ingredients. They provide reduced coefficients of friction while maintaining the characteristics of UHMWPE. Our featured component brands are Nolu-S, Nolu-SR and Nolu-SX.

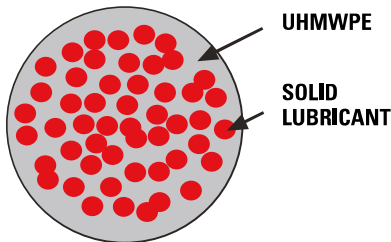

NOLU®-S

Nolu-S parts are made with a blend of UHMWPE and other dry lubricants that maintain good wear characteristics while significantly reducing coefficient of friction. Its unique self-lubricating properties make it ideal for applications requiring reduced friction and noise reduction.



FEATURES:

- RAM extruded or machined
- Very low coefficient of friction material flow
- High-impact strength
- Chemical resistant with minimal moisture absorption
- The Nolu®-S parts ingredients comply with EU and FDA food regulations
- Noise suppressant
- Easy to machine - most general power tools are sufficient

BENEFITS:

- Extends the life of mating surfaces
- Reduce surface marring and damage
- Reduces energy consumption
- Minimizes product pulsation on conveyors
- Low noise operation



MATERIALS AND CALCULATIONS - General index 7 3 5 1 0 a -

continue ►

7 3 5 6 0 a **Steel chain materials**

7 3 5 7 8 a **Coefficient of friction of standard materials**

7 3 5 8 6 a **Chemical resistance of standard materials**

7 3 5 7 6 a **Storage of plastic chains and belts & RoHs**

7 3 5 8 0 a **Coefficient of friction - Measurement procedure**

7 3 5 8 8 a **Application temperatures**

Chains & sprockets	Wear strips	Side guide brackets & accessories	Levelers	Engineering manual
Modular belts & sprockets	Chain & belt return systems	Frame & structure supports	Bearing supports	
Curves & tracks	Side guide solutions	Miscellaneous products	Equipment	



◀ back

7 3 5 7 4 a

NOLU®-S PARTS MATERIALS

NOLU®-SR PARTS

Nolu-SR parts have the same unique self-lubricating properties as Nolu®-S parts, however, they are made with additional proprietary ingredients. These unique ingredients increase the hardness of the material, providing superior wear resistance as compared to standard UHMWPE. Benefits of Nolu-SR parts include high wear resistance, extended wear life, minimization of product pulsation and low noise.

FEATURES:

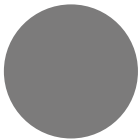

- RAM extruded or machined
- Superior wear resistance - greater than standard virgin or repro material
- Low coefficient of friction - promotes material flow
- High-impact strength
- The Nolu-SR parts are made with ingredients that comply with EU and FDA regulations
- Chemical resistant with minimal moisture absorption
- Easy to machine - most general power tools are sufficient

BENEFITS:

- Even greater wear resistance
- Extends the life of mating surfaces
- Reduce surface marring and damage
- Reduces conveyor chain loads
- Reduces energy consumption
- Reduces product pulsation on conveyors
- Low noise operation
- Suitable for running dry at higher speed

NOLU®-SX PARTS



Nolu-SX parts has the same unique self-lubricating properties as Nolu-SR parts; however, Nolu-SX parts has a material blend that reduces the thermal expansion characteristics of the material. The thermal expansion is reduced up to 40% compared to standard UHMWPE products, making it the ideal material for neck guides.

Nolu plastics should be stored at room temperature between 50°F (10°C) and 104°F (40°C) to prevent premature aging of the material. They should also be stored in a manner to prevent distortion. Regular cleaning is also recommended with warm water and soap agents with a pH value of 4.5 to 9.0. For more technical information regarding Nolu parts, please contact our Application Engineering Group.



MATERIALS AND CALCULATIONS - General index 7 3 5 1 0 a -

◀ back

7 3 5 6 0 a Steel chain materials

7 3 5 7 8 a Coefficient of friction of standard materials

7 3 5 8 6 a Chemical resistance of standard materials

7 3 5 7 6 a Storage of plastic chains and belts & RoHs

7 3 5 8 0 a Coefficient of friction - Measurement procedure

7 3 5 8 8 a Application temperatures

Chains & sprockets	Wear strips	Side guide brackets & accessories	Levelers	Engineering manual
Modular belts & sprockets	Chain & belt return systems	Frame & structure supports	Bearing supports	
Curves & tracks	Side guide solutions	Miscellaneous products	Equipment	



7 3 5 7 5 a CURVE, WEARSTRIPS, SIDE GUIDE, SPROCKETS AND RETURN ROLLER

MATERIALS

CURVES, WEARSTRIPS AND SIDE GUIDE MATERIALS

UHMWPE GREEN

ULTRA-HIGH MOLECULAR WEIGHT POLYETHYLENE (UHMWPE)

This Polyethylene polymer with extremely high molecular weight has several unique properties such as high abrasion resistance, impact strength and low coefficient of friction. The UHMWPE are used for our side guide profiles, curves and wearstrips.

UHMWPE BLACK

UHMWPE WHITE

UHMWPE WATER BLUE

UHMWPE-AS BLACK

ANTISTATIC ULTRA-HIGH MOLECULAR WEIGHT POLYETHYLENE (UHMWPE-AS)

This PE polymer with extremely high molecular weight has several unique properties such as good wear resistance, good impact strength, good sliding and antistatic properties. These properties make the material suitable for curves and straight tracks.

Surface Resistivity: $10^3 - 10^4 \Omega$; Volume Resistivity: $10^3 - 10^4 \Omega \cdot \text{cm}$.

NOLU®-CP

NOLU®-CP PARTS

Nolu-CP parts are made with Regal's exclusive compounds of UHMWPE and micro glass beads. Curves and neck guide made with this material are the most suitable for abrasive working conditions.

POM - GREEN

POM-ACETAL

POM - WHITE

This polyacetal used for roller guide provide a high rigidity, hardness and toughness and good chemical resistance to alkalis.

SPROCKETS, IDLER MATERIALS

PA BLACK

GLASS FIBER REINFORCED POLYAMIDE (PA-FV)

The reinforced polyamide with glass fiber is used for molded sprockets and idlers to offer a high strength and wear resistance.

PA WHITE

POLYAMIDE (PA)

The cast polyamide 6 is used for machined sprockets and idlers to offer a high strength and wear resistance.

RETURN ROLLERS MATERIALS

PE-HD BLACK

HIGH-DENSITY POLYETHYLENE (PE-HD)

PE-HD GREEN

The high-density polyethylene is used for return roller and it has a good abrasion resistance, impact strength and a low coefficient of friction.

PA BLACK

POLYAMIDE (PA)

PA GREEN

The impact polyamide resin is used for return roller to offer a high strength and wear resistance.



MATERIALS AND CALCULATIONS - General index 7 3 5 1 0 a -

7 3 5 6 0 a Steel chain materials

7 3 5 7 8 a Coefficient of friction of standard materials

7 3 5 8 6 a Chemical resistance of standard materials

7 3 5 7 6 a Storage of plastic chains and belts & RoHs

7 3 5 8 0 a Coefficient of friction - Measurement procedure

7 3 5 8 8 a Application temperatures



Chains & sprockets	Wear strips	Side guide brackets & accessories	Levelers	Engineering manual
Modular belts & sprockets	Chain & belt return systems	Frame & structure supports	Bearing supports	
Curves & tracks	Side guide solutions	Miscellaneous products	Equipment	



continue ►

7 3 5 7 6 a | STORAGE OF PLASTIC CHAINS AND BELTS AND RoHS MATERIALS

STORAGE OF PLASTIC CHAINS AND BELTS

Plastic chains, belts and components offer best stability and resistance against environmental effects at appropriate storage:

- In the original packaging, and not exposed to the environment
- Without environmental radiation / UV light / direct sunlight
- Dry
- In a non-aggressive environment
- A consistent temperature between 10°C (50° F) and 40°C (104° F)

FIRST IN, FIRST OUT

- We have applied that procedure in our logistic department.
- We recommend this procedure to any external warehouse.

Do not stack pallets or other heavy goods on top of chain packs. Chains inside the packs might get damaged. Do not stack chain packs higher than the original stacking height - as dispatched from our shipping department.

PRODUCT SHELF LIFE

PRODUCT CLASS	TIME FROM MANUFACTURING DATA	REFURBISH (INSPECT, CLEAN, RELUBRICATE AND REPACKAGE)	DON'T USE
All solid steel and cast iron	5 years	5 years	10 years
Plastic: rubber and EPDM	3 years	Not Applicable	3 years
Plastic: UHMWPE	3 years	Not Applicable	3 years
Plastic belts and Chains	3 years	Not Applicable	3 years
Plastic idler and sprockets	3 years	Not Applicable	3 years
Bearings	3 years	3 years	6 years

RoHS

System Plast® CHAINS, BELTS AND COMPONENTS materials do meet the base requirements of this european directive. Therefore, the RoHS (Restriction of Hazardous Substances) directive of 2002/95/CE and subsequent modifications do not apply to our products.

ATEX

FOR ATEX APPLICATION, CONTACT OUR TECHNICAL SUPPORT.

REACH

Regal materials meet the requirements of this European regulation.



MATERIALS AND CALCULATIONS - General index 7 3 5 1 0 a -

continue ►

7 3 5 6 0 a | Steel chain materials

7 3 5 7 8 a | Coefficient of friction of standard materials

7 3 5 8 6 a | Chemical resistance of standard materials

7 3 5 7 3 a | Nolu®-S parts

7 3 5 8 0 a | Coefficient of friction - Measurement procedure

7 3 5 8 8 a | Application temperatures

Chains & sprockets	Wear strips	Side guide brackets & accessories	Levelers	Engineering manual
Modular belts & sprockets	Chain & belt return systems	Frame & structure supports	Bearing supports	
Curves & tracks	Side guide solutions	Miscellaneous products	Equipment	



◀ back

7 3 5 7 7 a DISPOSAL OF PRODUCTS

DISPOSAL OF PLASTIC CHAINS AND BELTS

The non-electric nor electronics waste (plastic, rubber and metals parts) are not considered special waste and must be disposed of in strict compliance with the local regulations regarding non-special waste.

DISPOSAL OF MODSORT® MODULES

The wood packaging material of Modsor[®] modules is fully recyclable and FITOK certified in accordance with the ISPM-15 regulation.

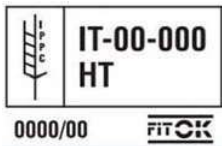

The electrical and electronic parts of Modsor[®] modules listed below are marked with the symbol



and classified as Waste of electric and electronic equipment (WEEE) in accordance with the European Directive 2012/19 / EU on WEEE.

- Control Card
- Divert Belt and Roller Top Belt's Motorized Drive Rollers (MDRs)
- Photo eyes
- Power Supply Unit

These WEEE must be disposed correctly at a suitable collection point according to the procedures in use in the country of disposal.



MATERIALS AND CALCULATIONS - General index 7 3 5 1 0 a -

◀ back

7 3 5 6 0 a Steel chain materials

7 3 5 7 8 a Coefficient of friction of standard materials

7 3 5 8 6 a Chemical resistance of standard materials

7 3 5 7 3 a Nolu®-S parts

7 3 5 8 0 a Coefficient of friction - Measurement procedure

7 3 5 8 8 a Application temperatures

Chains & sprockets	Wear strips	Side guide brackets & accessories	Levelers	Engineering manual
Modular belts & sprockets	Chain & belt return systems	Frame & structure supports	Bearing supports	
Curves & tracks	Side guide solutions	Miscellaneous products	Equipment	



7 3 5 7 8 a COEFFICIENTS OF FRICTION OF STANDARD MATERIALS

MATERIALS

Below listed coefficients can be used as a guideline. Depending on environmental and application requirements, (temperatures, lubricant, material combinations, dirt/debris, product and chain/belt surfaces, etc.) the coefficients are subject to some variation. Values are generally conservative.

COEFFICIENT OF FRICTION BETWEEN CHAIN/BELT AND WEARSTRIP:

CHAIN/BELT MATERIAL	LUBRICATION	WEAR STRIP MATERIAL					
		STAINLESS STEEL	UHMWPE PA	NOLU®-S PARTS	WOOD	RETURN ROLLER	EXTRA WITH METAL STRIP
Stainless steel	Dry	N/A	0.35	0.32	0.35	0.10	not applicable
	Dry lube	0.39	0.26	0.23	N/A	0.08	
	Water&Soap	0.20	0.18	0.15	N/A	0.05	
Carbon steel	Dry lube or Oil lube	0.39	0.26	0.23	N/A	0.08	not applicable
LF - Acetal	Dry	0.24	0.20	0.18	0.23	0.10	0.19
	Dry lube	0.18	0.17	0.13	N/A	0.07	0.14
	Water&Soap	0.15	0.10	0.10	N/A	0.05	0.10
NG®evo conveyor components made from engineered plastic resin	Dry	0.20	0.16	0.13	0.17	0.10	0.14
	Dry lube	0.16	0.10	0.08	N/A	0.07	0.09
	Water&Soap	0.14	0.09	0.08	N/A	0.05	0.09
PP / CR	Dry	0.29	0.24	0.21	0.22	0.10	0.23
	Dry lube	0.22	0.18	0.16	N/A	0.07	0.17

Valid for ambient temperature 21°C (70° F)

COEFFICIENT OF FRICTION BETWEEN CHAIN/BELT AND PRODUCT:

CHAIN/BELT MATERIAL	LUBRICATION	PRODUCT MATERIAL					
		PAPER CARTON	METAL (STEEL)	ALUMINUM	PLASTICS INCL. PET	GLASS (RETURN)	NEW GLASS, CERAMICS
Stainless steel	Dry	0.40	0.50	0.35	0.30	0.47	0.35
	Dry lube	N/A	0.34	0.29	0.24	0.30	0.29
	Water&Soap	N/A	0.20	0.15	0.15	0.21	0.15
Carbon steel	Dry lube or Oil lube	N/A	0.34	0.29	0.24	0.30	0.29
Speed - Line	Dry	0.40	0.45	0.32	0.27	0.40	0.29
	Dry lube	N/A	0.29	0.26	0.22	0.25	0.23
	Water&Soap	N/A	0.15	0.14	0.13	0.18	0.13
LF - Acetal	Dry	0.28	0.25	0.25	0.21	0.24	0.20
	Dry lube	N/A	0.19	0.17	0.15	0.17	0.14
	Water&Soap	N/A	0.15	0.14	0.13	0.14	0.12
NG®evo conveyor components made from engineered plastic resin	Dry	0.20	0.18	0.15	0.13	0.14	0.12
	Dry lube	N/A	0.15	0.13	0.11	0.12	0.11
	Water&Soap	N/A	0.13	0.12	0.10	0.11	0.10
LBP	Dry	0.10	0.10	0.10	0.10	0.10	0.10
VG	Dry	0.60	0.73	0.50	0.50	0.50	0.50
PP / CR	Dry	0.40	0.30	0.32	0.28	0.29	0.26
	Dry lube	N/A	0.23	0.25	0.21	0.22	0.20

Valid for ambient temperature 21°C (70° F)

For iCOF® device. Go to product page:

5 7 0 8 0 a



MATERIALS AND CALCULATIONS - General index 7 3 5 1 0 a -

7 3 5 8 0 a Coefficient of friction - Measurement procedure

7 3 5 7 3 a Nolu®-S parts

7 3 5 8 6 a Chemical resistance of standard materials

7 3 5 6 0 a Steel chain materials

7 3 5 7 6 a Storage of plastic chains and belts & RoHs

7 3 5 8 8 a Application temperatures



Chains & sprockets	Wear strips	Side guide brackets & accessories	Levelers	Engineering manual
Modular belts & sprockets	Chain & belt return systems	Frame & structure supports	Bearing supports	
Curves & tracks	Side guide solutions	Miscellaneous products	Equipment	



7 3 5 8 0 a **COEFFICIENT OF FRICTION - MEASUREMENT PROCEDURE**

MATERIALS

In this section, we will describe the measurement method for coefficient of friction (COF or μ) between belt/chain and product on a running conveyor.

The COF is defined as the ratio between the force necessary to move one surface horizontally over another and the pressure between the two surfaces. It can be measured by dividing the force required to push or pull an object by its weight. The pull and the product weight can be determined by measurement using a spring or force gauge. Please follow the below instructions, ensuring both conveyor and sample product are clean and clear of all debris:

1- At first be sure to have:

- a. Mechanical or digital spring gauge with suitable sensitivity and accuracy
- b. A spirit level gauge (in case of inclined conveyor)
- c. A suitable sample of product weight (bottles/cans etc.)
- d. Available space on the running conveyor where the COF measurement is required

2- Measure the sample weight (W):

- a. Use sample product with suitable weight. It is recommended to collect one or more products to get 1 kg of product weight.
- b. Measure the product weight using a scale or spring gauge
- c. Record the value when the scale is stabilized

3- Measure the pull (F₀):

- a. Be sure that conveyor is running and the surface is level. Otherwise measure carefully the angle
- b. With the same sample as step 2.a), take measurements in the same location on the conveyor and at the same speed if possible
- c. Secure the gauge to a fixed point on the conveyor or hold the gauge by hand avoiding movements.
If possible, steady your hand by resting it on conveyor frame or guide rail
- d. Ensure that the gauge is parallel to the conveyor
- e. Put the sample product on the conveyor, attach to spring gauge, and measure the horizontal pull (F₀).
- f. Take the value when the measurement is stabilized
- g. Make three (03) measurements at the same conditions
- h. Make the average of the obtained three (03) values
- i. Repeat steps 2 and 3 for multiple different containers

4- COF calculation:

- a. Be sure that the average W and F₀ values are in the same measurement unit (g or kg or lb);
- b. Use the formula $\mu = \frac{F_0}{W} = \frac{\text{measured pull}}{\text{measured weight}}$ to obtain the average value of COF; (4b)

Be aware that for some gauges it is required to compensate the reading with the plunger weight (P) (1) since it is used horizontally. Refer to page **7 3 5 8 1 a** for further details.

With the plunger weight compensation, the formula 4b) becomes:

$$\mu = \frac{(F_0 + P)}{W} = \frac{\text{measured pull} + \text{plunger weight}}{\text{measured weight}}$$

If the conveyor is inclined with respect to the running direction, the angle α is to be considered as following:

- Measure the angle α (usually from 2° to 5°);
- Use the formula $\mu = \frac{(F_0 + P)}{W \cos \alpha} - \tan \alpha$ (Running direction downwards) (1).
- Use the formula $\mu = \frac{(F_0 + P)}{W \cos \alpha} + \tan \alpha$ (Running direction upwards) (1).

Notes: (1) P=0 for spring gauges with adjustable preload. Refer to good measurement practice for further details.



MATERIALS AND CALCULATIONS - General index 7 3 5 1 0 a -

7 3 5 7 8 a Coefficient of friction of standard materials

7 3 5 7 3 a Nolu®-S parts

7 3 5 8 6 a Chemical resistance of standard materials

7 3 5 6 0 a Steel chain materials

7 3 5 7 6 a Storage of plastic chains and belts & RoHs

7 3 5 8 8 a Application temperatures



Chains & sprockets	Wear strips	Side guide brackets & accessories	Levelers	Engineering manual
Modular belts & sprockets	Chain & belt return systems	Frame & structure supports	Bearing supports	
Curves & tracks	Side guide solutions	Miscellaneous products	Equipment	



continue ►

7 3 5 8 1 a COEFFICIENT OF FRICTION - GOOD MEASUREMENT PRACTICE

MATERIALS

Here we describe good practices when measuring the COF within belt/chain in a running conveyor.

SELECTION OF THE INSTRUMENT

The higher the sensibility, the more accurate the measurement. 10 g divisions and +/- 10% (or ounces) is a good compromise for a rough estimation.

A. Gauge with mechanical spring (0-10 kg)

- i. Needs certain weight
- ii. Needs to compensate spring preload and "plunger"
- iii. Is more accurate / repeatable

There are spring gauges on the market with adjustable preload, in order to compensate the plunger. For those types of gauges, just adjust the reading scale to 0 when reading in horizontal position. Remember to reset the scale to 0 when reading values in vertical position (i.e. when weighting a bottle).

B. Digital gauge (0-45 kg)

- i. Needs lower weight
- ii. Don't always need to compensate for the "plunger"
- iii. Less accurate / repeatable

REQUIRED ACTIVITIES AND CHECKS PRIOR TO MEASUREMENT

A. Gauge with mechanical spring: Plunger preload determination

- i. Prior to the measurement ensure that also the spring dynamometer reads zero when in vertical working position. Tare if necessary.
- ii. Weight the dynamometer on a balance or using a second scale. Record the value. Weight reading of the total scale $x = A$ plunger preload + B scale body [g]
- iii. Hang the dynamometer upside down. If the instrument's own weight is not enough to pull the plunger by at least 10% of his own full scale, hang some additional weight at the bottom. The additional weight should be deducted from the reading.
- iv. Weight reading of the scale upside-down $y = B$ scale body - A plunger [g]. Read and store the value on the scale.

v. Plunger weight (spring preload) will be $A = \frac{x - y}{2}$ RECORD THIS VALUE!

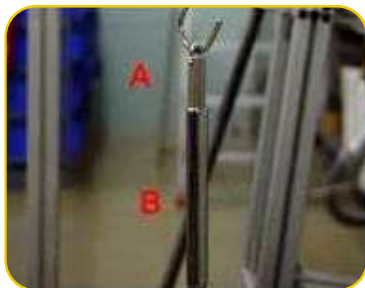

Example:

Gauge weights 140 g, upside-down reading is 36 g, the spring-preload is $(140-36)/2 = 52$ g. For the horizontal reading, you will have to add this value to the displayed force.



MATERIALS AND CALCULATIONS - General index 7 3 5 1 0 a -

continue ►

7 3 5 7 8 a Coefficient of friction of standard materials

7 3 5 7 3 a Nolu®-S parts

7 3 5 8 6 a Chemical resistance of standard materials

7 3 5 6 0 a Steel chain materials

7 3 5 7 6 a Storage of plastic chains and belts & RoHS

7 3 5 8 8 a Application temperatures

Chains & sprockets	Wear strips	Side guide brackets & accessories	Levelers	Engineering manual
Modular belts & sprockets	Chain & belt return systems	Frame & structure supports	Bearing supports	
Curves & tracks	Side guide solutions	Miscellaneous products	Equipment	



◀ back

7 3 5 8 2 a COEFFICIENT OF FRICTION - GOOD MEASUREMENT PRACTICE

MATERIALS

B. Digital gauge: Plunger preload determination

If your digital tool offers the possibility to switch it to horizontal, you don't need to calculate the plunger preload. In fact, in horizontal configuration, the cell automatically pre-sets to zero.

Some digital tools, on the contrary, do not allow to be switched to horizontal (they need a certain weight, given by the plunger when lying vertically to activate the cell). Under such condition proceed in plunger preload determination as per previous point.

Periodically check your instrument and compare the measurements with a second one. This is required to check any possible deviation of measurements due to loss of tare.

Recommendations

- A higher is the sample product weight, a lower is the error in the estimated value
 - If possible, we recommend using multiple containers to increase product weight
- Measure the product weight close to the ground so as to prevent any dropped bottles from breaking
- Take a stabilized measurement. Instrument gauge has a response time, so we recommend respecting this time to read an accurate value
- The more measurements that are taken and averaged, the more reliable the result will be.
- A smooth, clean surface allows an accurate COF measurement without the influence of wear
- Using the same sample(s) in all measurements will lead to a uniform and repeatable value
- Securing the gauge to a fixed point on the conveyor will remove human error from holding the spring gauge
- Ensure you hold the gauge and the plunger parallel to the conveyor, so as to achieve an accurate measurement



MATERIALS AND CALCULATIONS - General index 7 3 5 1 0 a -

◀ back

7 3 5 7 8 a Coefficient of friction of standard materials

7 3 5 7 3 a Nolu®-S parts

7 3 5 8 6 a Chemical resistance of standard materials

7 3 5 6 0 a Steel chain materials

7 3 5 7 6 a Storage of plastic chains and belts & RoHs

7 3 5 8 8 a Application temperatures

Chains & sprockets	Wear strips	Side guide brackets & accessories	Levelers	Engineering manual
Modular belts & sprockets	Chain & belt return systems	Frame & structure supports	Bearing supports	
Curves & tracks	Side guide solutions	Miscellaneous products	Equipment	

7 3 5 8 6 a CHEMICAL RESISTANCE OF STANDARD MATERIALS MATERIALS

Data shown in the table was taken from laboratory tests performed on unstrained samples and are merely indicative.

Chemical resistance under normal working conditions can depend on various factors, such as stress and temperature, concentration of the chemical agent and contact time. Conveyor rinsing can also be a huge factor, as a corrosive chemical that is allowed to dry and concentrate will be more problematic than one that is allowed contact for a short time and thoroughly rinsed away.



continue ►

VALID FOR AMBIENT TEMPERATURE (21°C / 70°F)

CHEMICAL AGENT	METALS								PLASTICS						RUBBERS											
	EXTRA		AISI 304		AISI 316		OT.NI		LF (POM)		NGE (PBT)		PP		PA		PE		EPDM		NBR		SEBS		VITON*	
	C%		C%		C%		C%		C%		C%		C%		C%		C%		C%		C%		C%		C%	
Acetic Acid	5	✓	20	✓	100	✓		○	5	✗	10	✓	40	✓	10	✗	10	✓	25	✓		✗	25	○	20	✗
Acetone		✓	25	✓		✓	✓			○		○		✓	100	✓		✓		✓		✗		○		✗
Acrylonitrile						✓								✓	100	✓		✓		✓		✗		○		✗
Aluminium chloride				○	10	○								○	10	✓		✓		✓		✓	✓	✓	SA	✓
Aluminium sulphate					SA	✓								✓	10	✓	SA	✓		✓		✓	✓	✓	SA	✓
Amyl alcohol				✓		✓					✓		✓	10	✓				✓					✓		✓
Ammonia		✓	100	✓		✓		✗		✓		○	30	✓	10	✓		✓		○		○	○	○		○
Ammonium chloride				○		✓						10	✓	10	✓		✓		✓		✓	✓	✓	SA	✓	✓
Aniline		✓			✓	✓							✓	100	○	3	✓		✗		✗	✗	✗			✓
Barium chloride				○	SA	✓							✓	10	✓		✓		✓		✓	✓	✓	✓	✓	✓
Beer		✓		✓		✓		✓		✓			✓				✓		✓		✓	✓	✓	✓	✓	✓
Benzene		✓	70	○		✓			✓		✓		✓				○		✗				✗			✓
Benzoic acid			100	✓	SA						✓	SA	SA	○				✗		✓		✓	✗		✓	
Benzol				✓		✓		✓		✓		○	100	✓			✓		✗		✗	✗	✗			○
Boric acid		○	SA	✓		✓			✗	10	✓	SA	✓	10	✓	SA	✓		✓		✓		✓	SA	✓	✓
Brine	10	✗		○		✓						○		○			✓		✓				○			○
Butter				✓		✓		✓		✓			✓				✓		✓		✓		○			✓
Butyl acetate						✓			✓		○	○	100	✓				○		○			○			✗
Butyl alcohol				✓					✓		✓		100	✓			✓		✓		○		✓			✓
Butyl glycole						✓					✓		100	✓			✓		✓				✓			✓
Calcium chloride		✗		○		✓		✓	10	✓		✓	50	✓	10	✓	SA	✓		✓			✓	SA	✓	✓
Carbon sulphide				✓		✓				✓			✓	100	✓		○		✗		✗	✗	✗			✓
Carbon tetrachloride			10	✓				✓		✓		✗		✓					✗		✗					✓
Chlorine water		✗		✗		○			✗	✗		✗					✓		3	○			3	○		
Chloroform		○	10	✓		✓		✓		✗	✗		○	100	✗		✗		✗		✗	✗	✗			✓
Chromic acid			25	✓	50	○			✗		○			1	○	50	○	50	○	✗		✗	50	✗	50	✓
Citric acid	10	✓		✓	SA			✗		○	10	✓	10	✓	10	○	SA	✓		✓		✓	✓	SA	✓	✓
Cyclohexane						✓					✓		✓	100	✓		✓		✗		✓		✗			✓
Cyclohexanol						✓					✓		✓	100	✓		✓		✗		✓		○			✓
Decalin						✓					○		○	✓				✗		○		○	✗			✗
Dioxane						✓			○		✓		○		✓		✓		○		○	✗	✗			✗
Distilled water		✓	10	✓		✓		✓		✓		✓		✓		✓		✓		✓		✓	✓			✗
Ethyl acetate				○		✓			○		○		✓	100	✓		✓			✗						○
Ethyl alcohol				✓						✓		96	✓	96	✓	96	✓			○						✓
Ethyl chloride				✓				○		✓		✗	100	✓		○			○		○					✗
Ethyl ether						✓					✓		✓	100	✓		○									✓
Ferric chloride				○		✓			○	10	✓		✓	10	✓		✓		✓		✓		✓	SA	✓	✓
Food fats		✓	100	✓		✓			✓		✓			✓		✓		○		✓		✓	○			✓
Food oils		✓		✓		✓			✓		✓			✓		✓		✓		✓		✓				✓

* Viton is believed to be the trademark and/or trade name of The Chemours Company FC, LLC and is not owned or controlled by Regal Beloit Corporation.

ABBREVIATION

- ✓ = good resistance
- = fairly good resistance depending on use conditions
- ✗ = insufficient resistance (not recommended)
- C = concentration
- SA = saturated
- blank spaces = no tests performed

All values are only applicable to temperatures below 21°C / 70°F.



MATERIALS AND CALCULATIONS - General index 7 3 5 1 0 a -

continue ►

7 3 5 6 0 a Steel chain materials

7 3 5 7 6 a Storage of plastic chains and belts & RoHS

7 3 5 8 0 a Coefficient of friction - Measurement procedure

7 3 5 7 3 a Nolu®-S parts

7 3 5 7 8 a Coefficient of friction of standard materials

7 3 5 8 8 a Application temperatures

Chains & sprockets	Wear strips	Side guide brackets & accessories	Levelers	Engineering manual
Modular belts & sprockets	Chain & belt return systems	Frame & structure supports	Bearing supports	
Curves & tracks	Side guide solutions	Miscellaneous products	Equipment	

7 3 5 8 6 b | CHEMICAL RESISTANCE OF STANDARD MATERIALS

MATERIALS

Data shown in the table was taken from laboratory tests performed on unstrained samples and are merely indicative.

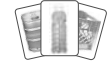

Chemical resistance under normal working conditions can depend on various factors, such as stress and temperature, concentration of the chemical agent and contact time. Conveyor rinsing can also be a huge factor, as a corrosive chemical that is allowed to dry and concentrate will be more problematic than one that is allowed contact for a short time and thoroughly rinsed away.

◀ back continue ▶

VALID FOR AMBIENT TEMPERATURE (21°C / 70°F)

CHEMICAL AGENT	METALS				PLASTICS						RUBBERS										
	EXTRA	AISI 304	AISI 316	OT.NI	LF (POM)	NGE (PBT)	PP	PA	PE	EPDM	NBR	SEBS	VITON*								
	C%	C%	C%	C%	C%	C%	C%	C%	C%	C%	C%	C%	C%								
Formaldehyde		✓	✓	✓	✓	✓	40	✓	30	✓	○	○	○	40	✗						
Formic acid	2	○	✗	100	✓	✓	10	✗	○	10	✗	85	✓	✓	○						
Freon 12			✓						✓	100	○		✓		✓						
Fresh water		✓	✓	✓		✓	✓	✓	✓	✓	✓	✓	✓	✓	✓						
Fruit juice		✓	○	✓		✓	✓	✓	✓	✓	✓	✓	✓	✓	✓						
Gasoline		✓	✓	✓	○	✓	○	○	✓	○	✗	○	✗	✓	✓						
Glycerine		✓	✓	✓	○	✓	✓	✓	✓	✓	✓	✓	✓	✓	✓						
Hydrochloric acid		✗	✗	✗	○	35	✗	20	○	30	✓	✗	35	✓	15	✓	15	✓	37	✓	
Hydrofluoric acid			✗	✗			5	○	40	✓	✗	70	✓		✗				48	✓	
Hydrogen peroxide	3	✓	✓	100	✓		30	✓	5	✓		✗	10	○	30	○	✗	30	✗	90	✓
Isopropyl alcohol				✓		✓	✓	✓	✓	✓	✓	✓	✓	✓	✓	✓	✓	✓	✓	✓	✓
Lactic acid		○		✓	✗	✓	10	✓	20	✓	✓	✓	✓	○	✓	○	✓	○	✓	✓	✓
Linseed oil			✓	✓		✓	✓	✓	✓	✓	✓	✓	✓	○	✓	○	✓	✗		✓	✓
Magnesium chloride			○	✓			✓	✓	✓	✓	✓	✓	✓	✓	✓	✓	✓	✓	✓	SA	✓
Methyl acetate			○	✓		○	○	✓	✓	✓	✓	✓	✓	○	✗	✗	✗	✗	✗	○	✓
Methyl alcohol			80	✓	✓	✓	✓	✓	✓	✓	✓	✓	✓	✓	○	○	✓	○	✓	○	✓
Methylene chloride		○	○	✓	✓	✗	✗	○	✓	○	○	○	✗	✗	✗	✗	✗	✗	○	○	✓
Milk		✓	✓	✓	✓	✓	✓	✓	✓	✓	✓	✓	✓	○	○	✓	✓	✓	✓	✓	✓
Mineral oil			✓	✓		✓	✓	✓	✓	✓	✓	✓	✓	✗	✓	✓	✗	✓	✗	✓	✓
Nitric acid	25	○	65	✓		✗		✓	✓	✗	○				10	✗			70	✓	
Nitrobenzene				✓			✓	✓	✓	○	✓		✗	✗	○	○	○	○	○	○	✓
Oxalic acid			65	✓	✓		10	✓	✓	○	✓	○	✓	○	○	○	○	○	○	○	✓
Paraffin				✓		✓	✓	✓	✓	✓	✓	✓	✓	○	○	○	✗		✓	✓	✓
Petroleum			✓	✓	✓	✓	✓	✓	✓	✓	✓	✓	✗	✗	✓	✓	✗	✓	✗	✓	✓
Petroleum ether			✓	✓	✓	✓	○	✓	✓	✓	✓	✓	✓	✗	✗	✗	✗	✗	✓	✓	✓
Phenol			✓	✓	✓	○	✗	✓	✓	✗	✓	✓	○	○	○	○	○	○	○	○	✓
Phosphoric acid	25	○	✗	✓	✓	✗	✗	✓	✓	✗	✓	✓	✓	✓	20	○	○	✓	85	✓	✓
Potassium bichromate				SA	✓			○	✓	○	SA	✓	✓	✓	○	○	○	○	SA	✓	✓
Potassium bromite				✓				✓	✓	✓	10	✓	✓	✓	✓	✓	✓	✓	✓	✓	✓
Potassium hydroxide		✓	50	✓	✓		✓	✗	✓	✓	✓	✓	✓	✓	○	○	✓	✓	✓	✓	✓
Potassium permanganate			✓	✓	✓	10	○	✓	✓	✓	✗	✓	10	✓	✓	✗	10	○	○	○	✓
Sea water		✗	✓	✓	✓	○	✓	✓	✓	✓	✓	✓	✓	✓	✓	✓	✓	○	○	○	✓
Silicone oil				✓			✓	✓	✓	✓	✓	✓	✓	✓	✓	✓	✓	✓	✓	✓	✓
Silver nitrate			○	✓				✓	✓	✓	✓	✓	✓	○	○	○	○	○	○	○	✓
Sodium carbonate		✓	100	✓	SA	✓	10	✓	10	✓	✓	✓	✓	✓	✓	✓	✓	✓	✓	✓	✓
Sodium chloride		○	○	✓	✓		✓	10	✓	✓	✓	✓	✓	✓	✓	✓	✓	✓	✓	SA	✓
Sodium hydroxide	40	✓	✓	60	✓		✓	10	✗		✓	✓	✓	✓	○	○	✓	✓	✓	✓	✓
Sodium hypochlorite			✗	SA	○		✗	10	✓	✓	✓	✓	10	✓	✓	✗	10	○	5	○	✓
Sodium silicate			100	✓	✓					✓	✓	✓	✓	✓	✓	✓	✓	✓	✓	✓	✓

* Viton is believed to be the trademark and/or trade name of The Chemours Company FC, LLC and is not owned or controlled by Regal Beloit Corporation.

ABBREVIATION

- ✓ = good resistance
- = fairly good resistance depending on use conditions
- ✗ = insufficient resistance (not recommended)
- C = concentration
- SA = saturated
- blank spaces = no tests performed

All values are only applicable to temperatures below 21°C / 70°F.



MATERIALS AND CALCULATIONS - General index 7 3 5 1 0 a -

◀ back continue ▶

7 3 5 6 0 a Steel chain materials

7 3 5 7 6 a Storage of plastic chains and belts & RoHS

7 3 5 8 0 a Coefficient of friction - Measurement procedure

7 3 5 7 3 a Nolu®-S parts

7 3 5 7 8 a Coefficient of friction of standard materials

7 3 5 8 8 a Application temperatures



Chains & sprockets	Wear strips	Side guide brackets & accessories	Levelers	Engineering manual
Modular belts & sprockets	Chain & belt return systems	Frame & structure supports	Bearing supports	
Curves & tracks	Side guide solutions	Miscellaneous products	Equipment	

7 3 5 8 6 c CHEMICAL RESISTANCE OF STANDARD MATERIALS

MATERIALS

Data shown in the table was taken from laboratory tests performed on unstrained samples and are merely indicative.



Chemical resistance under normal working conditions can depend on various factors, such as stress and temperature, concentration of the chemical agent and contact time. Conveyor rinsing can also be a huge factor, as a corrosive chemical that is allowed to dry and concentrate will be more problematic than one that is allowed contact for a short time and thoroughly rinsed away.

◀ back

VALID FOR AMBIENT TEMPERATURE (21°C / 70°F)

CHEMICAL AGENT	METALS				PLASTICS					RUBBERS			
	EXTRA	AISI 304	AISI 316	OT.NI	LF (POM)	NGE (PBT)	PP	PA	PE	EPDM	NBR	SEBS	VITON*
	C%	C%	C%	C%	C%	C%	C%	C%	C%	C%	C%	C%	C%
Sodium sulphate		100 ✓	✓	✓				✓	SA ✓	○	✓	✓	✓
Soft drinks		✓	✓	✓	✓	10 ✓	✓	✓	✓	✓	✓	✓	✓
Suds		✓	✓	✓		2 ✓	✓	✓	✓	✓	✓	✓	✓
Sulphuric acid	✗	✗	○	✓	✗	50 ✓	✓	✓	✗	80 ✓	50 ✓	✗	50 ○
Tartaric acid	✓	50 ✓	✓	✗	○	50 ✓	✓	✓	✓	✓	○	✓	✓
Tetrahydrofuran			✓		○	✓	○	✓	○	✓	✗	✗	✗
Tetralin		✗	✓		✓	✓	✗	✓	✓	✓	✗	✗	✗
Tincture of iodine		○	✓	✗			✓	✓	✓	○	✗	✗	○
Toluol	✓		✓			✓	✓	✓	✓	✓	✗	✗	✗
Transformer oil	✓		✓		✓	✓	○	✓	✓	✗	✓	✗	✓
Trichloroethylene		✗	100 ✓	✓	○	✗	○	○	○	✗	✗	✗	✓
Triethanolamin			✓			✓	✓	✓	✓	○	✗	○	✗
Turpentine	✓	✓	✓		✗	✓	✓		○	✗	✗	✗	✓
Vaseline			✓			✓		✓	○	✗	✓	✗	✓
Vegetable juice	✓	✓	✓		✓	✓	✓	✓	✓	✓	✓	✓	✓
Vegetable oils	✓	✓	✓		✓	✗	✓	✓	✓	○	✓	○	✓
Vinegar	✓	✓	100 ✓	✓	✓	10 ✓	✓	✓	✓	25 ✓	✓	○	25 ○
Water and soap	✓	✓	✓		✓	✓	✓	✓	✓	✓	✓	✓	✓
Whisky	✓	✓	✓	✓	✓	✓	✓	✓	✓	✓	✓	✓	✓
Wine	✓	✓	✓	✓	✓	✓	✓	✓	○	✓	✓	✓	✓
Xilol	✓	✓	✓	○	✗	✓	✗	✓	✓	✓	✗	✗	✗

* Viton is believed to be the trademark and/or trade name of The Chemours Company FC, LLC and is not owned or controlled by Regal Beloit Corporation.

ABBREVIATION

- ✓ = good resistance
- = fairly good resistance depending on use conditions
- ✗ = insufficient resistance (not recommended)
- C = concentration
- SA = saturated
- blank spaces = no tests performed

All values are only applicable to temperatures below 21°C / 70°F.



MATERIALS AND CALCULATIONS - General index 7 3 5 1 0 a -

◀ back

7 3 5 6 0 a Steel chain materials

7 3 5 7 6 a Storage of plastic chains and belts & RoHs

7 3 5 8 0 a Coefficient of friction - Measurement procedure

7 3 5 7 3 a Nolu®-S parts

7 3 5 7 8 a Coefficient of friction of standard materials

7 3 5 8 8 a Application temperatures



Chains & sprockets	Wear strips	Side guide brackets & accessories	Levelers	Engineering manual
Modular belts & sprockets	Chain & belt return systems	Frame & structure supports	Bearing supports	
Curves & tracks	Side guide solutions	Miscellaneous products	Equipment	

7 3 5 8 8 a APPLICATION TEMPERATURES

MATERIALS

For low and high temperature application please consult our Application Engineering department.

Be aware:

- If a chain, belt or other component is composed of several materials, all materials will have to be considered individually.
- Please note that the properties of a material change when the temperature changes
- In general, the impact resistance is reduced at low temperatures.
- The strength and wear resistance are reduced at elevated temperatures.
- High temperatures can also influence chemical resistance
- Some materials absorb moisture and expand/swell



MATERIAL	SYMBOL	USER FOR	MIN TEMP. °C	MAX. TEMP. °C		MIN TEMP. °F	MAX. TEMP. °F	
				DRY	WET		DRY	WET
Carbon steel	C45	Steel chains, roller chains	-70	180	not recommended	-95	350	not recommended
Ferritic stainless steel	Standard	Steel chains	-30	400	130	-20	750	265
Extra stainless steel	Extra	Steel chains	-30	400	130	-20	750	265
Extra plus stainless steel	Extra plus	Steel chains	-30	400	130	-20	750	265
Austenitic stainless steel	Austic	Steel chains, roller chains	-30	400	130	-20	750	265
Acetal resin	D,W	Plastic chains	-40	80	65	-40	175	150
Low friction acetal resin	LF (all colors)	Plastic chains and belts	-40	80	65	-40	175	150
Anti static acetal resin	AS	Plastic chains and belts	-40	80	not applicable	-40	175	not applicable
NG®evo conveyor components made from engineered plastic resin	NG®evo	Plastic chains and belts	-40	120	60	-40	250	140
Polypropylene	PP	Plastic chains and belts	5	104	104	41	220	220
Chemical resistant	CR	Plastic chains	5	104	104	41	220	220
Polyamide - PA High temperature resistance	HT	Plastic chains and belts	0	140	not applicable	30	285	not applicable
Polyphenylene sulfide Extra high temperature resistance	XT	Plastic chains and belts	-40	240	not applicable	-40	464	not applicable
Polyamide - PA Abrasion resistance	AR	Plastic chains	0	90	90	30	195	195
Thermoplastic rubber SEBS	TPR	VG chains and belts, gripper chains	-40	100	100	-40	210	210
NBR rubber	NBR	Gripper chains	-25	100	100	-15	210	210
EPDM rubber	EPDM	Gripper chains	-40	120	120	-40	250	250
EPDM-PP rubber	EPDM-PP	Gripper chains	-40	120	120	-40	250	250
Polyamide	PA	Sprockets, components	0	90	90	30	195	195
Polyamide reinforced	PA FV	Sprockets, bearing, components	0	90	90	30	195	195
Polypropylene	PP	Components	5	104	104	41	220	220
Polypropylene reinforced	PP FV	Bearing, components	5	104	104	41	220	220
Polyethylene	PE	Curves, components	-40	80	80	-40	175	175
Nolu®-S parts	Nolu®-S parts	Curves, components	-40	80	80	-40	175	175



MATERIALS AND CALCULATIONS - General index 7 3 5 1 0 a -

7 3 5 6 0 a Steel chain materials

7 3 5 7 6 a Storage of plastic chains and belts & RoHs

7 3 5 8 0 a Coefficient of friction - Measurement procedure

7 3 5 7 3 a Nolu®-S parts

7 3 5 7 8 a Coefficient of friction of standard materials

7 3 5 8 6 a Chemical resistance of standard materials

Chains & sprockets	Wear strips	Side guide brackets & accessories	Levelers	Engineering manual
Modular belts & sprockets	Chain & belt return systems	Frame & structure supports	Bearing supports	
Curves & tracks	Side guide solutions	Miscellaneous products	Equipment	

SYSTEM PLAST®

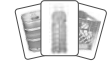

continue ►

7 3 7 0 0 a NG® EVO CONVEYOR COMPONENTS MADE FROM ENGINEERED PLASTIC RESIN

NG®
evo

Plastic Chains & Modular Belts

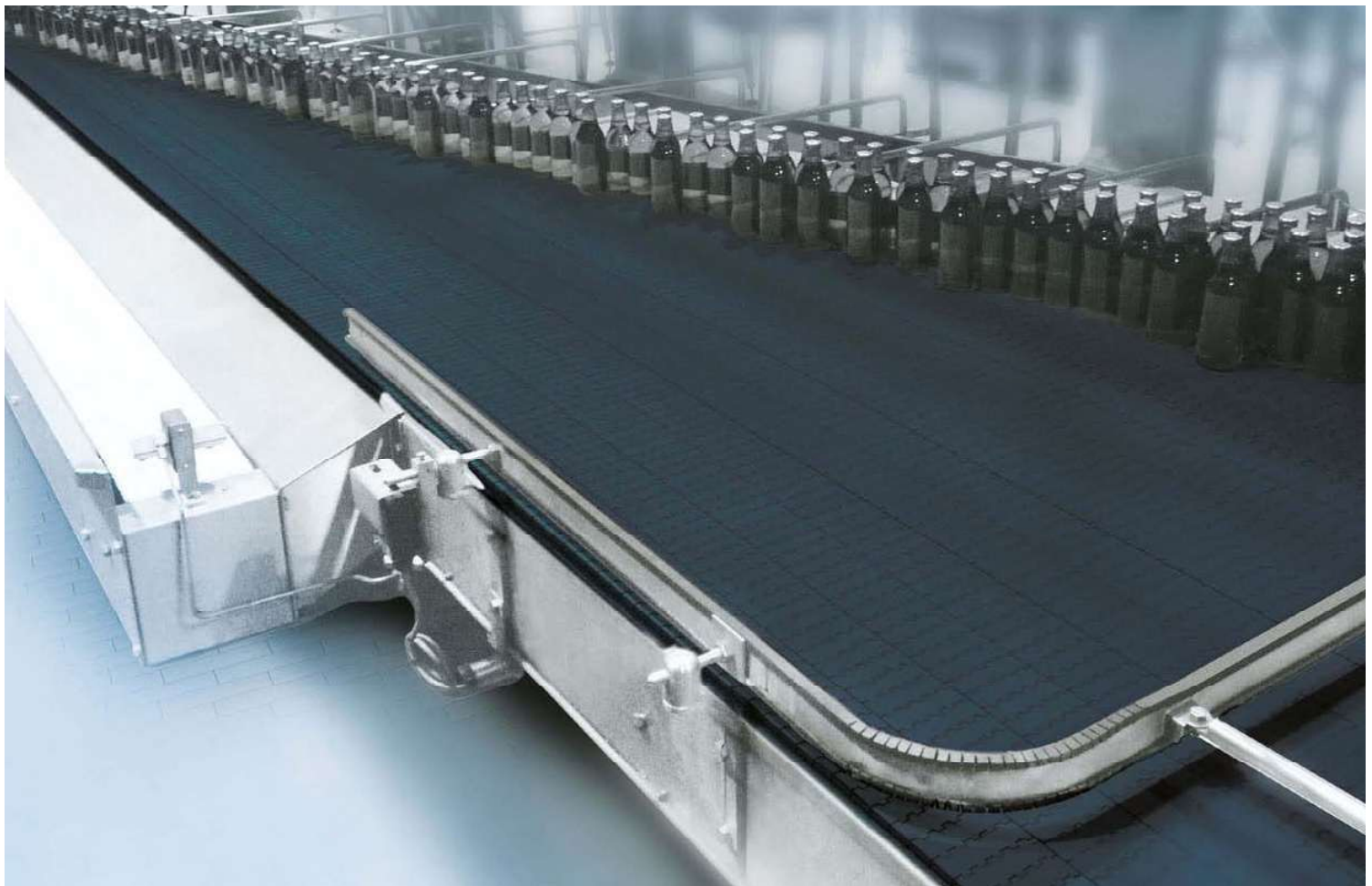

MATERIALS AND CALCULATIONS - General index **7 3 5 1 0 a** -

continue ►

Revision 001



Chains & sprockets	Wear strips	Side guide brackets & accessories	Levelers	Engineering manual
Modular belts & sprockets	Chain & belt return systems	Frame & structure supports	Bearing supports	
Curves & tracks	Side guide solutions	Miscellaneous products	Equipment	



7 3 7 0 1 a NG® EVO CONVEYOR COMPONENTS MADE FROM ENGINEERED PLASTIC RESIN



WHAT PLASTIC MATERIALS ARE USED IN NEW GENERATION® CONVEYOR COMPONENTS?

The System Plast® New Generation® family of chains and belts conveyor components are made of proprietary engineered resins designed to provide a sustainable advantage over “industry standard” materials. Their reduced coefficient of friction properties enable end users to reduce or eliminate their chain/belt lubrication thus providing a true “dry running” conveyor. Better sliding properties also result in reduced power consumption, increased wear life, reduced dust generation and the ability to run at higher speeds.

SYSTEM PLAST PRODUCTS ARE LEADING THE WAY WITH INNOVATION!

We introduced the New Generation® brand of conveyor components 20 years ago. It was soon recognized to offer new possibilities for running conveyors lines without lubrication. This enabled the reduction/elimination of soap & water or dry lubricants creating a safer work environment and cost savings. NG® conveyor components have also proven they provide longer wear life in comparison to acetal materials, and reduce noise levels in dry applications.

Regal expertise with unique materials and in-house integrated tool development is critical for consistent control over design and manufacturing processes.

MATERIAL EVOLUTION TO MEET YOUR GOALS

Understanding the growing demands on safety, hygiene, sustainability and TCO (total cost of ownership) - Regal challenged itself to improve the original formulation. This successful development created a new and improved resin used to make NG® Evolution conveyor components which helps to meet your goals. Your floors can be drier, bacteria growth can be reduced, energy and water consumption can be less and your TCO will be improved.

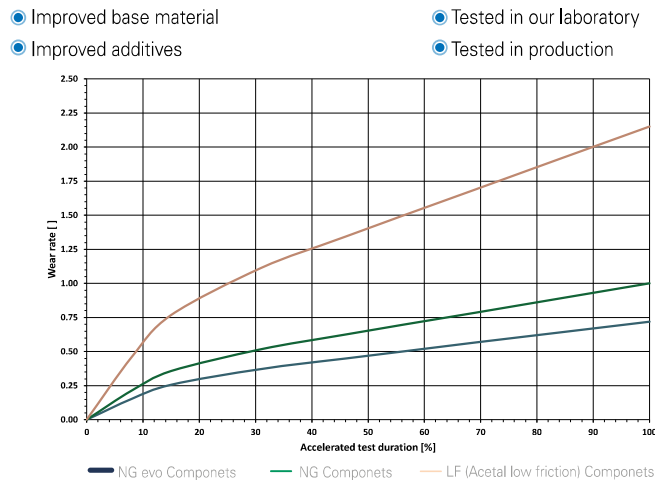

IMPROVEMENTS OF NG® EVO COMPARED TO NG® CONVEYOR COMPONENTS

- Lower friction - Friction is reduced up to 15%.
- Higher strength - Up to 10%
- Higher abrasion resistance
- Approved for direct food contact according to EU and FDA regulations



Chains & sprockets	Wear strips	Side guide brackets & accessories	Levelers	Engineering manual
Modular belts & sprockets	Chain & belt return systems	Frame & structure supports	Bearing supports	
Curves & tracks	Side guide solutions	Miscellaneous products	Equipment	

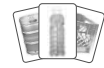

7 3 7 0 2 a NG® EVO CONVEYOR COMPONENTS MADE FROM ENGINEERED PLASTIC RESIN

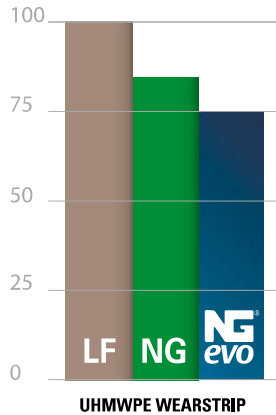

LOWEST COEFFICIENT OF FRICTION BETWEEN CHAIN /BELT AND WEARSTRIP

Coefficient of friction NG® evo conveyor components on UHMWPE wearstrip:

- 25% lower than LF acetal chain
- 15% lower than NG chain

Coefficient of friction values of 0,10 or even less are achievable in running dry applications

- Less power consumption
- Improved product stability
- Improved product flow
- Improved productivity

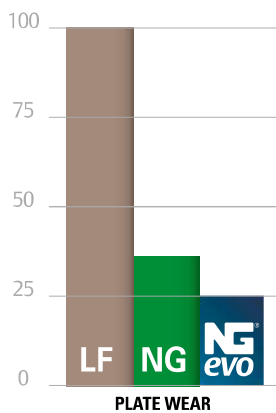

HIGHEST PLATE WEAR RESISTANCE

Plate wear in accelerated abrasion test after 5400 km run length

- 75% less wear than LF acetal chain
- 30% less wear than NG chain

Increased wear provides many advantages

- Less dust generation
- Reduced contamination
- Reduced cleaning requirements

NG® EVO CONVEYOR COMPONENTS ARE APPROVED FOR DIRECT FOOD CONTACT ACCORDING TO EU AND FDA REGULATIONS

NOISE REDUCTION:

With NG evo components the risk of noisy chains is greatly reduced compared to LF acetal chains. Squealing curves can be resolved and improve the work environment.

HIGH PV (PRESSURE VELOCITY) LIMIT:

With NG evo conveyor components, higher speeds and higher loads are achievable in dry running lines compared to LF Acetal chains. Additional speed and wear advantages can be also gained when used in combination with NOLU®-S or NOLU-SR curves.

CHEMICAL RESISTANCE:

NG evo conveyor components have a better chemical resistance than LF acetal materials, being compatible with most cleaning agents, especially in aseptic filling with the presence of H₂O₂ (hydrogen peroxide). The material in NG evo components, unlike many other materials used in the same application, do not get attacked by this chemical.

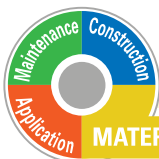

Chains & sprockets	Wear strips	Side guide brackets & accessories	Levelers	Engineering manual
Modular belts & sprockets	Chain & belt return systems	Frame & structure supports	Bearing supports	
Curves & tracks	Side guide solutions	Miscellaneous products	Equipment	

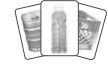

◀ back continue ▶

ENHANCED RUNNING DRY POSSIBILITIES WITH NG® EVO CONVEYOR COMPONENTS:

Contact Regal for assistance to help you achieve this goal.

An overview of the process is shown below :

STEP 1: GOAL TO RUN DRY

- Save water / lubricant consumption
- Eliminate wet floors • safety
- Less bacteria growth • hygiene
- Reduce maintenance
- Reduce energy consumption

STEP 2: DEFINE PROCESS PARAMETERS

- Layout
- Production / hour • speeds
- Geometry bottle, can, etc.

STEP 3: DEVELOP A ROBUST PROCESS

- Analyze the data from the previous step
- Discuss requirements and conditions with OEM and End user
- Select the correct products

STEP 4: IMPLEMENT DRY RUNNING

- Advise during installation
- Train operators

STEP 5: CONTROL AND IMPROVE PROCESS

- Monitor, follow up and make changes if necessary
- Analyze the collected data

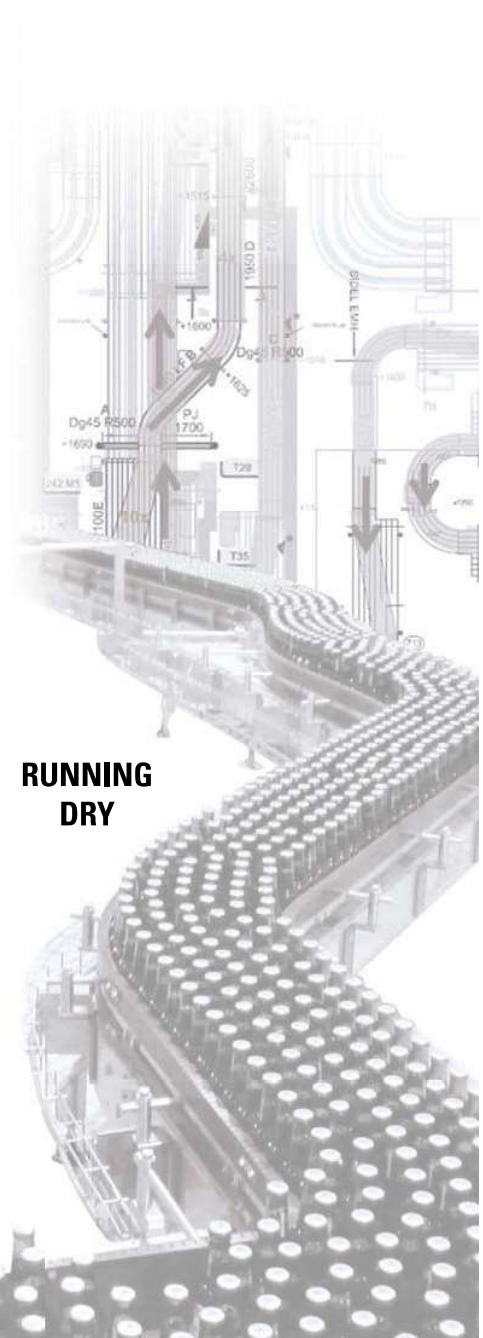

RUNNING DRY

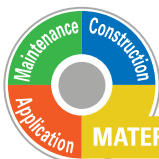

◀ back continue ▶



Chains & sprockets	Wear strips	Side guide brackets & accessories	Levelers	Engineering manual
Modular belts & sprockets	Chain & belt return systems	Frame & structure supports	Bearing supports	
Curves & tracks	Side guide solutions	Miscellaneous products	Equipment	



A SUCCESS STORY OF NG® CONVEYOR COMPONENTS



◀ back



DRY RUNNING SYSTEM PLAST® CONVEYOR COMPONENTS HELP HEINEKEN BREW A BETTER FUTURE WITH WATERLESS BOTTLING CONVEYORS IN ZOETERWOUE PLANT

THE TWO WATER FOOTPRINT NETWORK PARTNERS TEAM UP TO IMPROVE PLANT SAFETY AND SUSTAINABILITY BY REDUCING WATER USE, ENERGY CONSUMPTION, AND SOUND LEVELS AT ZOETERWOUE BREWERY.

Zoeterwoude, Netherlands 2014 - Heineken* N.V.'s global sustainability strategy, known as "Brewing a Better Future," produced a company-wide reduction of 20 percent in water use between 2008 and 2013. Playing a role in that improvement are System Plast NG® conveyor chain/belts and NOLU®-S wear track from System Plast S.r.l., a subsidiary of Regal Beloit Corporation (referred to from here on as "Regal"). The ultra-low-friction components, which are being deployed in phases at Heineken's Zoeterwoude brewery, eliminate the need for water and chemical-based lubrication on the filling lines - including those where abrasive particles from aluminum cans, party kegs and returnable glass bottles have been a problem in the past.

According to managers at the brewery, the dry running conveyor is producing a cascade of sustainability improvements with a cleaner, quieter, more energy-efficient and reliable plant. "We have experienced a wide variety of gains from the System Plast dry running conveyor," said Mr. Cok Duivenvoorden, Technical Line Manager at Zoeterwoude. "Specifically, we have improved plant safety and hygiene with dry equipment and floors. Maintenance is easier because of the cleanliness and better access where drip trays have been removed. We have reduced costs for water, lubricating chemicals and wastewater discharge. Dry operation is easier on conveyor bearings and frames, yet still reduces energy consumption because of the low-friction components. System Plast NG chain lasts up to five times longer than

low-friction acetal in some of our applications. And when installed to replace worn-out conveyor, the new chain pays for itself in as little as a year."

A JOINT GOAL TO REDUCE WATER USE IN BEVERAGE PROCESSING

One goal of Heineken's "Brewing a Better Future" sustainability program is to reduce water consumption by at least 25% by 2020, and both Heineken and Regal are pursuing dry conveying solutions as members of the Water Footprint Network. The network is a global organization of businesses, governmental agencies and environmental groups that promotes the transition to sustainable use of fresh water resources through increased awareness of how production and consumption of goods affect fresh water systems.

*Heineken is believed to be a trademark and/or trade name of Heineken Brouwerijen B.V. and is not owned or controlled by Regal Beloit Corporation.



◀ back

Chains & sprockets	Wear strips	Side guide brackets & accessories	Levelers	Engineering manual
Modular belts & sprockets	Chain & belt return systems	Frame & structure supports	Bearing supports	
Curves & tracks	Side guide solutions	Miscellaneous products	Equipment	



7 3 9 9 5 a APPLICATION CONSIDERATIONS

The proper selection and application of power transmission products and components, including the related area of product safety, is the responsibility of the customer. Operating and performance requirements and potential associated issues will vary appreciably depending upon the use and application of such products and components. The scope of the technical and application information included in this publication is necessarily limited. Unusual operating environments and conditions, lubrication requirements, loading supports, and other factors can materially affect the application and operating results of the products and components and the customer should carefully review its requirements. Any technical advice or review furnished by Regal Beloit America, Inc. and its affiliates with respect to the use of products and components is given in good faith and without charge, and Regal assumes no obligation or liability for the advice given, or results obtained, all such advice and review being given and accepted at customer's risk.

For a copy of our Standard Terms and Conditions of Sale, Disclaimers of Warranty, Limitation of Liability and Remedy, please contact Customer Service.

These terms and conditions of sale, disclaimers and limitations of liability apply to any person who may buy, acquire or use a Regal Beloit America Inc. product referred to herein, including any person who buys from a licensed distributor of these branded products.

INSPECTION AND MAINTENANCE 73010a

72110a CONSTRUCTION DETAILS

APPLICATIONS 72510a

73510a MATERIALS AND CALCULATIONS



Chains & sprockets	Wear strips	Side guide brackets & accessories	Levelers	Engineering manual
Modular belts & sprockets	Chain & belt return systems	Frame & structure supports	Bearing supports	
Curves & tracks	Side guide solutions	Miscellaneous products	Equipment	

Item description	Page code	Item description	Page code	Item description	Page code	Item description	Page code
1400..D	11590a	820..WL	11050a	BKR-77W43P..	53535a	CL-RD8-PD..	51650a
1400..R	11590a	820..WML	11050b	BKR-77W43S..	53535a	CL-RD8-PF	51650a
1400V..R	11600a	820..WMS	11050b	BKR-84W31LP..	53525b	CON..	50600a
1700..D	11550a	820..WS	11050a	BKR-85W44P..	53545b	CON-H7816M-S	51690a
1700..DMS	11550a	821..D	11320b	BKR-87W31LP..	53525b	CON-H8716M-S	51700a
1700..RB	11560a	821..R	11320b	BKR-88W43P..	53535b	CRBFTRS..	56044a
1700..RC	11560a	821..W	11320b	BKR-93W43LP..	53535b	CRBFTRS..	56074a
1700..RM	11550a	821..WMS	11320b	BKZ-154-SS	53580a	CS..	56100a
1700..RMS	11550a	878..D	11270a	BPS-4020..	54040a	CSHOE..	50600a
1874..	11140a	878..RB	11270a	CAP-10M..	53605a	DS-25M52	54520a
1874..	11450a	878..RC	11270a	CAP-25M..	54530a	DS-30M52	54520a
2080..DM	30027a	880..DMS	11260a	CAP-30M..	54530a	DTS..	53600a
2080..DMS	30027a	880..DS	11260a	CAP7023-P-YT	56300b	F-100..	51090a
2120..	30160a	880..RMS	11260a	CAP7023-B30M..	56300b	F-26..	51090a
2120..DS-PK2	30160c	880..RS	11260a	CAP8437-P-YT	56300b	F-50..	51090a
2122..	30166a	880T..W	11260d	CAP-8437-B40M..	56300b	F-60..	51090a
2124..	30165a	880T..WMS	11260d	CAP-50M..	54530a	F-70..	51090a
2190..	30235a	881..DMS	11090a	CC-16..	53610a	F-90..	51090a
2250..	30395a	881..DS	11090a	CC-19-12MK-12MK	53620a	FT-HDL..	54560a
2251..	30550a	881..RMS	11090a	CC-20..	53620a	FT-LOCK..	54570a
2256..	30740a	881..RS	11090a	CC-25-12MK..	53620a	FT-MAG..	54570a
2256ST..	30740b	881T..W	11090b	CC-25-14M..	53615a	GRSHOE-S330	50600b
2260..	30715a	881T..WMS	11090b	CC-25-15M..	53615a	GNP..	56300a
2260..DS-PK2	30715b	882..DMS	11300a	CC-25-16M..	53615a	GP..	54540a
2351..	30760a	882..DS	11300a	CC-25-18M..	53615a	GRINGK..	11090d
2500..	30615a	882..RMS	11300a	CC-25-20M..	53615a	GRP.EPDM	11440b
2502..	30618a	882..RS	11300a	CC-42-12MK..	53620a	GRP.NBR	11440a
2508..	30640a	882T..W	11300b	CC-42-12MQ..	53630a	GRPK.NBR	11440a
2630..	30650a	BCK..	50600a	CC-52-R..	53650a	GRPN..NBR	11430a
500..	56300b	BEC-19	56044a	CC-52-S..	53645a	GRSHOE-S330	50600b
515..DMS	11130a	BEC-24	56074a	CJ..	54520a	HDL-117..	54560a
515..RMS	11130a	BEO-19	56044a	CL..	56090a	HDL-120..	54560a
600..RM	11580a	BEO-24	56074a	CL-1020S	52550a	HDL-94..	54560a
800..DMS	11120a	BK-47W44..	53545b	CL-1540S	52530a	HNG..	54550a
800..DMS-F	11120b	BK-49W31L	53525b	CL-6065X38	50600a	HUB110..	11270a
800..DMS-FSS	11120b	BK-50W43	53535b	CL-CON-P..	51600a	ICOF-CAN	57080a
800..RMS	11120a	BK-55W43L	53535b	CL-CON-P25..	51630a	ICOF-GLASS	57080a
800..WMS	11120b	BKE-85W22..	53555a	CL-CON-PD..	51610a	ICOF-PET	57080a
800..FSS	11120b	BKF-35W31L..	53555a	CL-CON-R	51820a	ICOF-SLIDER-CAN	57080a
815..D	11040a	BKF-61W38..	53560a	CL-D..	51660a	ICOF-SLIDER-GLASS	57080a
815..DMS	11040b	BKF-65W30L..	53555a	CL-H45S	52521a	ICOF-SLIDER-PET	57080a
815..DMS-F	11090d	BKF-66W31L..	53515a	CL-H5210..	52594a	IND-142B..	53635a
815..DS	11040a	BKF-66W31L..	53515b	CL-H7816M..	51690a	IND-350R..	53635a
815..FSS	11090d	BKF-79W30..	53555a	CL-H8716M..	51700a	MODFLEX...A90R	57035a
815..RMS	11040b	BKF-89W38..	53560a	CL-H9014M..	51680a	MODFLEX...A180R	57055a
8157..DMS	11100a	BKL..SS	53580a	CL-RD10-P..	51640a	MODFLEX...A90L	57040a
8157..DMS-F	11100b	BKR-67W44P..	53545b	CL-RD10-P258M	51650a	MODFLEX...A180L	57060a
8157..FSS	11100b	BKR-69W31LP..	53525a	CL-RD10-PD..	51650a	MODFLEX...A90R-TM	57045a
820..D	11200a	BKR-69W31LP..	53525b	CL-RD12-P..	51640a	MODFLEX...A180R-TM	57065a
820..DM	11200b	BKR-69W31LS..	53525a	CL-RD12-P258M	51650a	MODFLEX...A90L-TM	57050a
820..DMS	11200a	BKR-69W44P..	53545a	CL-RD12-PD..	51650a	MODFLEX...A180L-TM	57070a
820..DS	11200a	BKR-69W44S..	53545a	CL-RD14-P..	51640a	MODSORT-AI2..	57015a
820..RM	11200b	BKR-70W43P..	53535b	CL-RD14-P258M	51650a	MODSORT-MSGK...	57020a
820..RMS	11200b	BKR-72W43P..	53535a	CL-RD20-P..	51640a	MODSORT-MPES..	57020a
820..RS	11200b	BKR-72W43S..	53535a	CL-RD8-P..	51640a	MODSORT-MPEK	57020a
820..W	11050a	BKR-75W43LP..	53535b	CL-RD8-P258M	51650a	MODSORT-MPS...	57020a

Legend

Codes ending with .. indicate a group of item descriptions all starting with the code listed. Example: 2122.. (all item descriptions starting with 2122).
 Codes with .. in the middle indicate a group of item descriptions starting and ending with the codes listed. Example 2251..RS (all item descriptions starting with 2251 and ending with RS). **Information about item descriptions, printed in blue, is only available on our website: www.SystemPlastSmartGuide.com**

Chains & sprockets	Wear strips	Side guide brackets & accessories	Levelers	Engineering manual
Modular belts & sprockets	Chain & belt return systems	Frame & structure supports	Bearing supports	
Curves & tracks	Side guide solutions	Miscellaneous products	Equipment	

Item description	Page code	Item description	Page code	Item description	Page code	Item description	Page code
KMD01..	50050a	KNF-50H56..	54600a	LF879TAB..	11230a	LFG2251FT-P.VG-3	30490c
KMD02..	50050a	KNF-53H45..	54600a	LF880..	11240a	LFG2251FT-PT.VG	30490d
KMD03..	50020a	KNF-80H51..	54600a	LF8800P..	11240b	LFG2251FT-PT.VG-2	30490d
KMD04..	50050a	KNM-20H13..	54610a	LF880M..	11220a	LFG2251FT-PT.VG-3	30490d
KMD05..	50030a	KNM-25H16..	54610a	LF880TAB..	11230a	LFG2251FT-PT.VGS	30495d
KMD06..	50020a	KNM-30H21..	54610a	LF882M..	11280a	LFG2251FT-PT.VGS-2	30495d
KMD07..	50020a	KNM-40H26..	54610a	LF882TAB..	11290a	LFG2251FT-PT.VGS-3	30495d
KMD08..	50020a	KNM-50H32..	54610a	LFB2080FT..	30025a	LFG2251FT-TAB..	30710a
KMD09..	50020a	KNM-50H40..	54600a	LFB2120FG..	30070a	LFG2251LBP..	30500a
KMD10..	50020a	LA100..	55585a	LFB2120FT..	30050a	LFG2252PT..	30481a
KMD11..	50030a	LA100..	55825a	LFB2250FG..	30360a	LFG2253FT..	30330a
KMD12..	50030a	LA100-SH..	55810a	LFB2250FT..	30325a	LFG2260FT-M..	30700a
KMD21..	50040a	LA110..	55600a	LFB2253FT..	30330a	LFG2351..	30745a
KMD22..	50040a	LA120E-02B..	55645a	LFB2253RT..	57015a	LFG2351..VG	30755a
KMD23..	50040a	LA123H-02B..	55645a	LFB2253RTC..	30398a	LFG2451TAB..	30750a
KMD24..	50080a	LA40..	55525a	LFB2256..	30730a	LFG2508FTS..	30620a
KMD25..	50080a	LA50..	55540a	LFB2256..VG	30735a	LFG2551..	30745a
KMD26..	50080a	LA60..	55555a	LFG1700	11530a	LFG2630FTS..	30645a
KMD27..	50080a	LA60-01..	55630a	LFG1702	11530a	LFG2651TAB..	30750a
KMD28..	50080a	LA60H-01..	55630a	LFG1710..	11540a	LFG-COMB2500..	30615a
KMD31..	50040a	LA60S-01..	55630a	LFG1710-CTAB..	11540a	LFM30..	55750a
KMD32..	50040a	LA80..	55570a	LFG2120FG..	30070a	LFM40..	55750a
KMD33..	50040a	LA80H..	55570a	LFG2120FT..	30050a	LFM50..	55750a
KMD37..	50040a	LA80S..	55780a	LFG2120FT-PT..	30060b	NGE1400V..TAB	11600a
KMD39..	50060a	LAF100SH-01..	55630a	LFG2120FT-PT.VG-2	30100d	LFW1400..	11590a
KMD40..	50060a	LAF123H..	55840a	LFG2120FT-PT.VG-3	30100d	LFW1400V..TAB	11600a
KMD41..	50060a	LAF123H-02B..	55660a	LFG2120FT-PT2..	30060b	LFW1431..	11590a
KMD42..	50060a	LAS100..	55615a	LFG2250FG..	30360a	LFW1700	11530a
KMD48..	50060a	LAS120..	55615a	LFG2260FG-M..	30700a	LFW1701-TAB	11530a
KMD52..	50060a	LAS80..	55615a	LFG2250FG-PT..	30360c	LFW1702	11530a
KMD61..	50050a	LAX100..	55810a	LFG2250FG-PT2..	30360c	LFW1710..	11540a
KMD62..	50050a	LAX102..	55795a	LFG2250FT..	30325a	LFW1710-CTAB..	11540a
KMD64..	50101a	LAX123..	55840a	LFG2250FT..VG	30370a	LFW600..	11570a
KMD66..	50101a	LAX123-02B..	55660a	LFG2250FT..VG-2	30370b	LFW600F	11580a
KMD68..	50070a	LB100	55735a	LFG2250FT..VG-3	30370b	LFW631 TAB	11580a
KMD71..	50070a	LB150	55735a	LFG2250FT..VGS	30380a	LMM120..	55720a
KMD78..	50070a	LB200	55735a	LFG2250FT..VGS-2	30380b	LMM80..	55720a
KMD82..	50070a	LB80	55735a	LFG2250FT..VGS-3	30380b	LMP125..	55705a
KMD84..	50101a	LF1700	11530a	LFG2250FT-K330	30310a	LMP80..	55705a
KMD85..	50101a	LF1701-TAB	11530a	LFG2250FT-PT..	30335b	LMPH123..	55735a
KMD86..	50101a	LF1702	11530a	LFG2250FT-PT..VG	30370d	LSHOE-S330	50600b
KMD87..	50101a	LF1843 SS TAB..	11470a	LFG2250FT-PT..VG-2	30370d	LSS100..	55675a
KMD88..	50101a	LF1843 TAB..	11470a	LFG2250FT-PT..VG-3	30370d	LSS125..	55675a
KMD90..	50091a	LF820..	11190a	LFG2250FT-PT2..	30335b	LSS50..	55675a
KMD91..	50091a	LF820P..	11190a	LFG2250FT-PT-K330	30310a	LSS75..	55675a
KMD92..	50091a	LF821..	11320a	LFG2250FT-TAB..	30710a	LSSC100..	55690a
KMD93..	50091a	LF8257..	11310a	LFG2251FT..	30440a	LSSC125..	55690a
KMD96..	50091a	LF828..	11210a	LFG2251FT..VG	30490a	LSSC75..	55690a
KMD97..	50101a	LF831..	11190a	LFG2251FT..VG-2	30490b	SNB2080..	30029a
KNF-30H21..	54610a	LF843..	11460a	LFG2251FT..VG-3	30490b	NB2120..	30175a
KNF-40H26..	54610a	LF845..	11460a	LFG2251FT..VGS	30495a	SNB2120..	30175a
KNF-50H32..	54610a	LF877TAB..	11230a	LFG2251FT..VGS-2	30495b	NGD1873TAB..VG	11420a
KNF-50H39..	54600a	LF878TAB..	11230a	LFG2251FT..VGS-3	30495b	NGE1400..	11590a
KNF-50H40..	54600a	LF879..	11240a	LFG2251FT-M..	30700a	NGE1431..	11590a
KNF-50H41..	54600a	LF8790P..	11240b	LFG2251FT-P..VG	30490c	NGE1700	11530a
		LF879M..	11220a	LFG2251FT-P..VG-2	30490c	NGE1701-TAB	11530a

Legend

Codes ending with .. indicate a group of item descriptions all starting with the code listed. Example: 2122.. (all item descriptions starting with 2122).
 Codes with .. in the middle indicate a group of item descriptions starting and ending with the codes listed. Example 2251..RS (all item descriptions starting with 2251 and ending with RS). **Information about item descriptions, printed in blue, is only available on our website: www.SystemPlastSmartGuide.com**

Chains & sprockets	Wear strips	Side guide brackets & accessories	Levelers	Engineering manual
Modular belts & sprockets	Chain & belt return systems	Frame & structure supports	Bearing supports	
Curves & tracks	Side guide solutions	Miscellaneous products	Equipment	

Item description	Page code	Item description	Page code	Item description	Page code	Item description	Page code
NGE1702	11530a	NGE2250FG-P2..	30360b	NGE880..	11240a	R-60..83-PEG	51080a
NGE1863 TAB..	11490a	NGE2250FG-P-K330	30340a	NGE8800..	11240b	R-60..85-PEB-S	51110a
NGE1863SS TAB..	11490a	NGE2250FG-PT..	30360c	NGE8800P..	11240b	R-60..85-PEG	51080a
NGE1873SS TAB..	11470a	NGE2250FG-PT..T	30350a	NGE880M..	11220a	R-9B4..	52680a
NGE1873SS TAB..GS	11440b	NGE2250FG-PT2..	30360c	NGE880TAB..	11230a	RF-11B4..	52680a
NGE1873SS TAB..GS..	11440a	NGE2250FT..	30325a	NGE880TAB..VAC43X2	11235a	RF-17B6..	52680a
NGE1873SS TAB..VG	11420a	NGE2250FT-K330	30310a	NGE882LBP TAB..	11360a	RF-21B6..	52680a
NGE1873SS TAB..VG85QH8.5	11425a	NGE2250FT-P..	30335a	NGE882LBP..	11360a	RF-24B6..	52680a
NGE1873TAB..	11470a	NGE2250FT-P2..	30335a	NGE882M..	11280a	RF-40..86-PEG	51080a
NGE1873TAB..GS	11440b	NGE2250FT-PT..	30335b	NGE882M..VG	11400a	RF-41..B	51020a
NGE1873TAB..GS..	11440a	NGE2250FT-PT..T	30320a	NGE882TAB..	11290a	RF-41..G	51060a
NGE1873TAB..VG	11420a	NGE2250FT-PT2..	30335b	NGE882TAB..VG	11400a	RF-47..G	51030a
NGE2080FT..	30025a	NGE2250FT-PT-K330	30310a	NGE-S-K38..	11330a	RF-50..28-PEG	51040a
NGE2120FG..	30070a	NGE2250FT-PT-K330T	30320a	PAB-COMB2500..	30615a	RF-50..43-PEG	51050a
NGE2120FG-P..	30075a	NGE2250FT-TAB..	30710a	PC-125110..	53640a	RF-50..86-PEG	51080a
NGE2120FG-P2..	30075a	NGE2251FT..	30440a	PC-25..	53610a	RF-50..B	51030a
NGE2120FG-PT..	30075b	NGE2251FT-K330	30420a	PC-25T..	54530a	RF-60..43-PEG	51050a
NGE2120FG-PT2..	30075b	NGE2251FT-M..	30700a	PC-30T..	54530a	RF-60..86-PEG	51080a
NGE2120FT..	30030a	NGE2251FT-PT..	30450b	PC-9075..	53635a	RF-60..G	51030a
NGE2120FT..	30050a	NGE2251FT-PT..T	30430a	PC-KIT	53640a	RG-105H..	52570a
NGE2120FT..GB	30120a	NGE2251FT-PT..TL	30430a	PC-KIT-0M	53605a	RG-105H49..3000A	52572a
NGE2120FT..GB-2	30120b	NGE2251FT-PT-K330	30420a	PC-KIT-19M	53605a	RG-105H49..3000S	52571a
NGE2120FT..GB-3	30120b	NGE2251FT-TAB..	30710a	PCO-H7816M-B	51690a	RG-105H49..348	52590a
NGE2120FT..VG50	30100a	NGE2251LBP..	30500a	PCO-H8716M-B	51700a	RG-105H52..3000S	52594a
NGE2120FT..VG50-2	30100b	NGE2251LBP-P..	30500b	PCO-H9014M-G	51680a	RG-105H81..3000A	52572a
NGE2120FT..VG50-3	30100b	NGE2252FT..	30445a	P-D..	51830a	RG-105H81..3000S	52571a
NGE2120FT..VGS50	30105a	NGE2252FT..	30420a	PE..	51830a	RG-165..	52520a
NGE2120FT-P..	30060a	NGE2252FT-PT..	30420a	PEN-H7816M-B	51690a	RG-210H50..	52570a
NGE2120FT-P..VG50	30100c	NGE2253FT..VAC43	30398n	PEN-H8716M-B	51700a	RG-210H50..3000A	52572a
NGE2120FT-P2..	30060a	NGE2260FT-M..	30700a	PEN-H9014M-G	51680a	RG-210H50..3000S	52571a
NGE2120FT-PT..	30030b	NGE600..	11570a	PF..	51830a	RG-240..	52521a
NGE2120FT-PT..	30060b	NGE820..	11190a	PG..	51830a	RG-240H45..3000S	52530a
NGE2120FT-PT..T	30045a	NGE820P..	11190a	PK-D12M110	51830a	RG-86H..	52570a
NGE2120FT-PT..VG50	30100d	NGE821..	11320a	PM10..	51830a	RG-86H49..3000A	52572a
NGE2120FT-PT2..	30060b	NGE821..VG	11410a	PMB..	54530a	RG-86H49..3000S	52571a
NGE2120LBP..	30110a	NGE821LBP..	11370a	PP1873SS TAB..GS..	11440b	RG-86H49..348	52590a
NGE2120M..	30720a	NGE8257..	11310a	PPW2502DT..	30617a	RG-86H81..3000A	52572a
NGE2121FT..	30030a	NGE8257..VG	11410a	PP878TAB..GS..	11430b	RG-86H81..3000S	52571a
NGE2121FT..	30055a	NGE8257LBP..	11370a	PPG2500RR..	30610a	RG-86H81..3000S	52571a
NGE2121FT-PT..	30030b	NGE828..	11210a	R-26..B	51020a	RG..	52550a
NGE2122FG..	30073a	NGE831..	11190a	R-26..G	51060a	RGC18-86H49..	52592a
NGE2124FT..	30030a	NGE831..VG	11380a	R-40..83-PEB-S	51110a	RGC20-105H49..	52592a
NGE2124FT..VG	30090a	NGE831LBP..	11340a	R-40..83-PEG	51080a	RGC32-86H49..	52593a
NGE2124FT-PT..	30030b	NGE863..	11460a	R-40..85-PEG	51080a	RGC33-105H49..	52593a
NGE2124FT-PT..VG	30090a	NGE877TAB..	11230a	R-41..B	51020a	RH-45..	54620a
NGE2190FG..	30230a	NGE878LBP..	11350a	R-41..G	51060a	RH-65..	54620a
NGE2190FG..	30220a	NGE878TAB..	11230a	R-49..G	51040a	RH-80..	54620a
NGE2190FG-PT..	30220a	NGE878TAB..GS..	11430b	R-50..27-PEG	51040a	RPAD10004	55810a
NGE2190FT..	30210a	NGE878TAB..GS..	11430a	R-50..41-PEG	51050a	RPAD10108	55600a
NGE2190FT..	30200a	NGE878TAB..VG	11390a	R-50..43-PEG	51050a	RPAD11207	55615a
NGE2190FT-PT..	30200a	NGE879..	11240a	R-50..83-PEB-S	51110a	RPAD11207	55645a
NGE2190FT-PT..T	30215a	NGE879LBP TAB..	11350a	R-50..83-PEG	51080a	RPAD12208	55660a
NGE2250FG..	30360a	NGE879M..	11220a	R-50..85-PEB-S	51110a	RPAD12208	55645a
NGE2250FG-K330	30340a	NGE879M..VG	11380a	R-50..85-PEG	51080a	RPAD12208	55840a
NGE2260FG-M..	30700a	NGE879TAB..	11230a	R-60..41-PEG	51050a	RPAD12506	55705a
NGE2250FG-P..	30360b	NGE879TAB..VG	11390a	R-60..83-PEB-S	51110a	RPAD12506	55720a

Legend

Codes ending with .. indicate a group of item descriptions all starting with the code listed. Example: 2122.. (all item descriptions starting with 2122).
 Codes with .. in the middle indicate a group of item descriptions starting and ending with the codes listed. Example 2251..RS (all item descriptions starting with 2251 and ending with RS). **Information about item descriptions, printed in blue, is only available on our website: www.SystemPlastSmartGuide.com**

Chains & sprockets	Wear strips	Side guide brackets & accessories	Levelers	Engineering manual
Modular belts & sprockets	Chain & belt return systems	Frame & structure supports	Bearing supports	
Curves & tracks	Side guide solutions	Miscellaneous products	Equipment	

Item description	Page code	Item description	Page code	Item description	Page code	Item description	Page code
RPAD3206	55525a	SP-10944T15	53545a	TCHD-R150-R150-S	54080a	TTM87..	50101a
RPAD4206	55540a	SP-11253T15	53545a	TC-R150-S	54080a	TTM90..	50091a
RPAD5207	55630a	SP-7550..	53515a	TEE..	54080a	TTM91..	50091a
RPAD5306	55555a	SP-R36T..	53535a	TEE-3815-BM10	54080a	TTM92..	50091a
RPAD7207	55615a	SPSL815..	11020a	TEE-4415-BM10	54080a	TTM93..	50091a
RPAD7207	55570a	SPSL881MO..	11060a	TEE-4815-BM10	54080a	TTM96..	50091a
RPAD8006	55705a	SPT-10..	51160a	TE-R..	55765a	TTM97..	50101a
RPAD8006	55720a	SPT-11L..	51130a	TE-S..	55765a	TTMK..	50565a
RPAD9308	55585a	SPT-15..	51150a	TME..	52670a	TUBE-R10S-6000	53605a
RPAD9308	55795a	SPT-16..	51160a	TME-K..	52671a	TWP-S4030..	55765c
RPAD9308	55615a	SPT-2..	51130a	TOP-20P	53585a	UC..	56300a
RPAD9308	55825a	SPT-4..	51130a	TOP-23P..	53585a	UCFB..	56140a
RR-47..83-PEB-S	51110a	SPT-4..	51160a	TOP-23S..	53585a	UCFG..	56080a
RR-47..83-PEG	51080a	SPT-84..	51120a	TOP-24P..	53585a	UCFH..	56020a
RR-47..85-PEB-S	51110a	SPT-84..	51160a	TOP-24S..	53585a	UCFH..	56030a
RR-47..85-PEG	51080a	SQL..	56130a	TOP-25S..	53585a	UCFH..	56042a
RR-57..27-PEG	51040a	SR800..	11120a	TOP-40P..	53585a	UCFH..ME..	56040a
RR-57..41-PEG	51050a	SS802..	11120a	TOP-40S..	53585a	UCFHXX..	56042a
RR-57..43-PEG	51050a	SS812..	11030a	TOP-60S..	53585a	UCFL..	56020a
RR-57..83-PEB-S	51110a	SS881M..	11060a	TOP-90S..	53585a	UCFL..ME..	56040a
RR-57..83-PEG	51080a	SS881MO..	11060a	TTM01..	50050a	UFLX..	56020a
RR-57..85-PEB-S	51110a	SSA805..	11120a	TTM02..	50050a	UFLQ..	56072a
RR-57..85-PEG	51080a	SSA815..	11030b	TTM03..	50020a	UFLZ..ME..	56040a
RR-67..41-PEG	51050a	SSA8810..	11080a	TTM04..	50050a	VG-009M-01	51630a
RR-67..83-PEB-S	51110a	SSA8810TAB..	11070a	TTM05..	50030a	VG-011..	51620a
RR-67..83-PEG	51080a	SSE515..	11130a	TTM06..	50020a	VG-012-01	51620a
RR-67..85-PEB-S	51110a	SSE805..	11120a	TTM07..	50020a	VG-013..	51620a
RR-67..85-PEG	51080a	SSE805..VG	11180a	TTM08..	50020a	VG-016-02	51630a
RRF-40..86-PEG	51080a	SSE815..	11030a	TTM09..	50020a	VG-018M..	51630a
RRF-50..86-PEG	51080a	SSE8157..	11100a	TTM10..	50020a	VG-022-01	51630a
RRF-57..28-PEG	51040a	SSE8157..VG	11180a	TTM11..	50030a	VG-113SM-08G	51820a
RRF-57..43-PEG	51050a	SSE8157TAB..VG	11180a	TTM12..	50030a	VG-1568M..	52611a
RRF-60..86-PEG	51080a	SSE8810..	11080a	TTM21..	50040a	VG-213..	53565a
RRF-67..43-PEG	51050a	SSE881..VG	11170a	TTM22..	50040a	VG-213R-TOP..	53590a
RSHOE-S330	50600b	SSE881M..	11060a	TTM23..	50040a	VG-222JO..	51810a
S800..	11030b	SSE881MO..	11060a	TTM31..	50040a	VG-223R..	53565a
S815..	11030b	SSE881MO..	11160a	TTM32..	50040a	VG-223R-TOP..	53590a
SCREW21M5-SS	30615a	SSE8810..	11080a	TTM33..	50040a	VG-245..	53575a
SF-CD1..	54540a	SSE8810TAB..	11070a	TTM37	50040a	VG-253..	53570a
SF-SPS..	54540a	SS8810TAB..	11070a	TTM39..	50060a	VG-254..	53570a
SHOE-15L105..	51150a	SSE881RTAB..	11070a	TTM40..	50060a	VG-3050..	54020a
SHOE-48..	52611a	SSE881TAB..VG	11170a	TTM41..	50060a	VG-3051..	54050a
SHOE-49L26	52592a	SSE8857M..	11110a	TTM42..	50060a	VG-3052..	54050a
SHOE-49L42	52593a	SSE8857M..VG	11160a	TTM48..	50060a	VG-3055..	54050a
SHOE-53L102..	51150a	SSE8857TAB..	11110a	TTM52..	50060a	VG-3070..	54060a
SHOE-84L244..	51170a	SSEL815..	11020a	TTM61..	50050a	VG-3080..	54060a
SHOE-84L68..	51160a	SSEL815..	11030a	TTM62..	50050a	VG-3087..	54060a
SHOE-85L244..	51170a	SSEL881MO..	11060a	TTM64..	50101a	VG-3110..	54070a
SHOE-88L244..	51170a	SSER814..VG	11150a	TTM66..	50101a	VG-3115..	54070a
SHOE-89L152..	51170a	SSER815..VG	11150a	TTM68..	50070a	VG-60..	53615a
SHOE-94..	52611a	SSER815TAB..VG	11150a	TTM71..	50070a	VG-619..	53610a
SK38..DMS	11330a	SSL812..	11030a	TTM78..	50070a	VG-620..	53615a
SK38..RMS	11330a	SSL881MO..	11060a	TTM82..	50070a	VG-632..	54560a
SMB-60..	53625a	SSSR815..	11030a	TTM84..	50101a	VG-633..	54550a
SP-10049..	53535a	TC-20..	53610a	TTM85..	50101a	VG-634..	54550a
		TC-60..	53625a	TTM86..	50101a	VG-641T..	53590a

Legend

Codes ending with .. indicate a group of item descriptions all starting with the code listed. Example: 2122.. (all item descriptions starting with 2122).

Codes with .. in the middle indicate a group of item descriptions starting and ending with the codes listed. Example 2251..RS (all item descriptions starting with 2251 and ending with RS). **Information about item descriptions, printed in blue, is only available on our website: www.SystemPlastSmartGuide.com**

Chains & sprockets	Wear strips	Side guide brackets & accessories	Levelers	Engineering manual
Modular belts & sprockets	Chain & belt return systems	Frame & structure supports	Bearing supports	
Curves & tracks	Side guide solutions	Miscellaneous products	Equipment	

Item description	Page code	Item description	Page code	Item description	Page code	Item description	Page code
VG-686A-1.25-3M	52611a	VG-JSL075-125..	50530a	VG-Q-75-40..	53595a		
VG-687-1.4-3M	52612a	VG-JSL075-188..	50530b	VG-QSC..	53595a		
VG-687-3.3-3M	52612a	VG-L20M..	50520a	VG-QT-01	53595a		
VG-687FLEX-1.4-3M	52610a	VG-LGSF..	51520a	VG-S1020M..	51660b		
VG-687H-1.4-3M	52611a	VG-LGSR..	51520a	VG-S1040M..	50560a		
VG-687H-3.3-3M	52611a	VG-LGST..	51520b	VG-S330M..	50580a		
VG-687LDB-M8	52612a	VG-LSSF..	51520a	VG-S4-330M..	50580a		
VG-687NP-1.4M	52612a	VG-LSSM..	51520a	VG-S4P330C..	50580b		
VG-687SP	52611a	VG-LSSMT..	51520c	VG-S4-S3020..	50550a		
VG-688-1.4-3M	52614a	VG-LSSR..	51520a	VG-S640M..	50560a		
VG-688-3.3-3M	52614a	VG-LSST..	51520b	VG-S840M..	50560a		
VG-688FLEX-1.4-3M	52610a	VG-LSST..	51520a	VG-SC..	54630a		
VG-688H-1.4-3M	52613a	VG-LSST..	51520c	VG-SCL..	54630a		
VG-688H-3.3-3M	52613a	VG-LSSWF..	51520a	VG-SD..	51660a		
VG-750-10	50550b	VG-LSSWF..	51520b	VG-SP1040M..	50560a		
VG-A2520..	51740b	VG-MBG-50-NS-10	50570a	VG-SP330C..	50580b		
VG-A330M..	50580a	VG-NG110..	51720a	VG-SP640M..	50560a		
VG-A600A..	51740a	VG-NG125..	51720a	VG-SP840M..	50560a		
VG-A840..	52650a	VG-NG47..	51720a	VG-SSF-HT-10	51520a		
VG-ABG..	51730a	VG-NG49..	51720a	VG-SSMT..	51520c		
VG-AP330C..	50580b	VG-NG50..	51720a	VG-SSTS..	51520b		
VG-BP..	54030a	VG-NG81..	51720a	VG-T425M..	50550b		
VG-BPT..	54030b	VG-NG91..	51720a	VG-TP..	54030a		
VG-BPV..	54030b	VG-P1040M..	50560a	VG-U3041..	50550a		
VG-BWS-125-10	50570a	VG-P105..	50650a	VG-U3042..	50550a		
VG-DB83M-B-10	51710a	VG-P10MRD..	51710a	VG-U3043..	50550a		
VG-F203M..	50550b	VG-P12MRD..	51710a	VG-U4045..	50550a		
VG-F205M..	50550b	VG-P14BC..	50650a	VG-J23..	50520a		
VG-F205M..	51120a	VG-P14HD..	50650b	VG-Z18M..	50520a		
VG-F206M..	51120a	VG-P18BC..	50650a	VG-Z20M..	50520a		
VG-F253M..	50550b	VG-P18CC-100	50530a	VG-Z20WM..	50520a		
VG-F303M..	50550b	VG-P18HD..	50650b	VG-Z21..	50520a		
VG-F403..	50550a	VG-P2520..	51740b	VT1701T..	50170a		
VG-F403M..	50550b	VG-P316BC..	50650a	VT1710CT..	50170a		
VG-F503M..	50550b	VG-P316HD..	50650b	VT1713CT..	50180a		
VG-F603M..	50550b	VG-P330C..	50580a	VT1873T..	50160a		
VG-F703M..	50550b	VG-P330CW..	50610a	VT880B..	50130a		
VG-G1020M..	51660b	VG-P330M..	50560a	VT880T..	50110a		
VG-GD..	51660a	VG-P516BC..	50650b	VT882..	50140a		
VG-H7816M..	51690a	VG-P640M..	50560a	VT882B..	50150a		
VG-H14022M..	51703a	VG-P650M..	50560a	VTC880..	50120a		
VG-H8716M..	51700a	VG-P680M..	50560a	VTR880B..	50130a		
VG-H9014M..	51680a	VG-P7GABC..	50650a	VTR882B..	50150a		
VG-J100-125T..	50530a	VG-P7GAHD..	50650b	W1700	11530a		
VG-J100-188..	50530b	VG-P813..	51740a				
VG-J21M..	50520a	VG-P816..	51740a				
VG-J23M..	50520a	VG-P822..	51740a				
VG-JEL-078..	50530a	VG-P834..	51740a				
VG-JL19M..	50520a	VG-P840DBM..	51710a				
VG-JS100-125..	50530a	VG-P840M..	50560a				
VG-JS100-188..	50530b	VG-P8MRD..	51710a				
VG-JS150-125..	50530a	VG-PBG5..	51730a				
VG-JS150-18..	50530b	VG-PBG7..	51730a				
VG-JS200-125..	50530a	VG-PD..	51660b				
VG-JS200-188..	50530b	VG-PM10BC..	50650b				
VG-JS3-075-125..	50530a	VG-PM4BC..	50650a				

Legend

Codes ending with .. indicate a group of item descriptions all starting with the code listed. Example: 2122.. (all item descriptions starting with 2122).
 Codes with .. in the middle indicate a group of item descriptions starting and ending with the codes listed. Example 2251..RS (all item descriptions starting with 2251 and ending with RS). **Information about item descriptions, printed in blue, is only available on our website: www.SystemPlastSmartGuide.com**